

\$7.50

Disco

Automotive Hardware

Distributor Supply Company

Catalog 2011-2012

About Disco

Purchased in 1986, Disco Automotive Products started as a master distributor of automotive fasteners for the automotive aftermarket. Disco is a family owned business that saw the need to manufacture as well as distribute a large selection of OEM and specialty fasteners. Over nearly a quarter of a century, Disco has evolved into a complete line of Automotive products.

Our company goal
Complete Customer Satisfaction with our Products and Service.

We service our customer's needs through our worldwide network of authorized Disco distributors and market through traditional channels of distribution. Selling only to authorized distributors, we offer three types of packaging: small "unit package" quantities, a one price "retail program" and in large "bulk quantities". In addition, we offer a variety of assortments and merchandising aids.

The Disco catalog is a complete reference for the Automotive Hardware Industry. Our latest edition features OEM cross reference guides, actual size illustrations as well as complete specifications and dimensions.

Disco's management has over 100 years combined experience in selling and working with automotive hardware. We are committed to working closely with your sales staff to aide them in selling more products.

If you have any questions or concerns, please feel free to contact us.

Disco Automotive Hardware

P.O. Box 858, Sulphur, OK 73086
Tel: 580-622-3090 Fax: 580-622-3781
E-Mail: discosales@discoautomotive.com
www.discoautomotive.com

Table of Contents

Quick Reference	iv
Numerical Index	vi
Conversion Table	xvii
Section Index	xix
Section 1	
Screws	1
Section 2	
Standard & Metric Fasteners	23
Section 3	
Special Nuts	39
Section 4	
Shield Retainers	71
Section 5	
Windshield Fasteners	123
Section 6	
Door Fasteners	127
Section 7	
Headlight Fasteners	171
Section 8	
Miscellaneous	177
Section 9	
Rivets	201
Section 10	
Electrical Products	215
Section 11	
Tools	243
Section 12	
Assortments	247
Section 13	
Service Equipment	307
Section 14	
Sales Aids	317
O.E.M. Index	xxi

Quick Reference

Assortments	247	Hinges	170
Bins	313	Hole Plugs	194
Body Shims	195	Hose Clamp Rack	315
Bolts		Hose Clamps	198
Bumper	28	Interior Panel Fasteners	140
Frame	34	Labels - Body Shop Bin	334
Metric Flange	38	Nuts	
Boxes		Barrel	43
Corrugated	314	Extruded "U"	51
Metal Storage	311	Flange	46
Nylon Storage	308	Metric	38, 47
Parts	312	Standard	33, 46
Bulbs		Fold Over	48
Headlight	228	Free Spinning Washer	47
Miniature	219	Grille	58
Cabinets	313	Headlamp Adj. w/ Mounting Screw	172
Cable Ties	217	Hex	
Clips		Metric	37
"E"	32	Standard	34
Grille	97	Hex Type Insert	70
Hood Insulation	75	Jack	29
Loom Routing	216	License Plate	65
Moulding	178	Lock	31
Reveal Glass Moulding	124	Metric	37
Routing	216	Rubber Well	30
Universal Moulding	192	"U" Type Speed	48
Windshield Moulding	124	USS	34
Christmas Tree Merchandiser	324	Thread Cutting	44
Cost Recovery Program	320	Weld	69
Cotter Pins	35	Wing	68
Door		Nylon Cable Straps	217
Handle Retainers	128	Pigtails	235
Hinge Bushings	160	Posters	318
Hinge Pins	162	Razor Blade	
Lock Clips	128	Nylon	197
Trim Clips	139	Single Edge	197, 245
Drain Plugs	196	Retainers	
Drill Bits	245	Bumper Strip	83
Electrical Harnesses	235	Door Handle	128
Fuses	218	Door Trim Panel	140

Quick Reference

Grille	97	Torx	
Push On	40	Oval Head	12
Push Type	97	Pan Head	13
Weatherstrip	89	Trim	12
Window Guide	158	Service Equipment	308
Windshield Hose	126	Trays	308
Wire Type	139	U-Nuts	48
Rivet Guns	244	Wall Charts	318
Rivets		Washers	
Automotive	205	Fender	33
Door Window Regulator	159	Flat	
Nylon	202	Metric	37
Push Type	98	SAE	33
Screw	115	USS	33
Special	202	Lock	
Standard		Metric	37
Aluminum/Aluminum	212	Standard	33
Aluminum/Steel	214	Weatherstrip (Sponge)	197
Steel/Steel	213	Wire Harnesses	235
Sample Boards	327	Wire Terminals	239
Screws			
Finishing Sems	5		
Headlamp Adjusting	172		
Hex Head			
Cap			
Metric	36		
Standard	32		
Loose Washer	13		
Slotted	5		
Teks	5		
License Plate	17		
Mounting	7		
Phillips			
Flat Top	7		
Oval	3		
Pan	4		
Machine	20		
Teks	4		
Trim	2		
Rivet	115		

Numerical Index

1EP. 318	533PK 3	863PK 37	990PK 41
1SP. 319	534PK 3	865PK 37	991PK 42
101PK 31	535PK 3	866PK 37	996PK 172
145PK 33	539PK 3	867PK 37	1000PK. 25
146PK 33	542PK 3	869PK 36	1001PK. 25
147PK 33	545PK 3	870PK 36	1003PK. 172
148PK 33	552PK 2	871PK 36	1012PK. 53
149PK 33	555PK 3	872PK 36	1013PK. 27
204PK 24	557PK 3	873PK 36	1017PK. 47
206PK 25	558PK 3	874PK 36	1019PK. 172
210PK 24	559PK 3	875PK 36	1024PK. 142
231PK 29	560PK 3	876PK 36	1026PK. 178
233PK 29	561PK 3	877PK 36	1040PK. 46
240PK 28	577PK 139	878PK 36	1041PK. 46
256PK 33	578PK 139	879PK 36	1042PK. 46
259PK 46	579PK 139	880PK 36	1043PK. 43
262PK 45	589PK 194	881PK 36	1044PK. 43
263PK 45	592PK 141	884PK 36	1077PK. 5
264PK 45	637PK 57	885PK 36	1078PK. 5
265PK 44	656PK 172	886PK 36	1079PK. 5
308PK 192	681PK 172	887PK 36	1080PK. 5
315PK 193	688PK 40	888PK 36	1083PK. 130
344PK 193	690PK 40	889PK 36	1087PK. 99
345PK 193	708PK 43	890PK 36	1091PK. 194
347PK 193	709PK 44	891PK 36	1095PK. 31
477PK 17	710PK 44	892PK 36	1107PK. 173
485PK 4,21	711PK 44	893PK 36	1123PK. 213
486PK 4	724 219	894PK 36	1146 244
487PK 4	724A 219	895PK 36	1149PK. 80
489PK 4	729PK 239	896PK 36	1159PK. 178
492PK 4	753 219	897PK 36	1172PK. 178
493PK 4	757 219	899PK 36	1183PK. 4
494PK 4	767 220	900PK 36	1184PK. 3
495PK 4	768 220	903PK 36	1185PK. 4
496PK 4	789 220	904PK 36	1186PK. 3
497PK 4	7168 220	905PK 36	1187PK. 4
498PK 4	797 220	906PK 36	1188PK. 3
499PK 4	812PK 128	907PK 36	1192PK. 50
500PK 4	816PK 124	938PK 51	1195PK. 202
501PK 4	817PK 125	938ZPK. 51	1201PK. 147
502PK 4	825PK 124	969PK 85	1202PK. 57
503PK 4	853PK 173	972PK 172	1204 244
504PK 4	855PK 28	985PK 125	1227PK. 58
505PK 4	856PK 45	986PK 125	1228PK. 66
506PK 4	861PK 37	987PK 178	1234PK. 112
511PK 13	862PK 37	989PK 41	1237PK. 216

Numerical Index

1238PK. 216	1334PK. 32	1539 34	1646PK. 140
1239PK. 216	1335PK. 32	1540 34	1648PK. 145
1240PK. 216	1336PK. 32	1541 34	1650PK. 18
1249PK. 132	1337PK. 32	1542 34	1651PK. 37
1250PK. 132	1338PK. 32	1558PK. 145	1652PK. 37
1251PK. 161	1339PK. 32	1560PK. 63	1654PK. 37
1252PK. 161	1340PK. 32	1562PK. 159	1655PK. 37
1263PK. 104	1341PK. 32	1563PK. 158	1656PK. 37
1265PK. 117	1342PK. 32	1566PK. 158	1657PK. 37
1267PK. 160	1343PK. 32	1568PK. 158	1658PK. 37
1268PK. 162	1344PK. 32	1570PK. 159	1659PK. 37
1269PK. 160	1345PK. 32	1572PK. 60	1661PK. 37
1270PK. 161	1346PK. 32	1573PK. 86	1662PK. 37
1273PK. 41	1347PK. 32	1574PK. 59	1663PK. 37
1274PK. 41	1348PK. 32	1575PK. 147	1664PK. 37
1275PK. 42	1349PK. 32	1576PK. 63	1681PK. 159
1276PK. 43	1350PK. 49	1577PK. 58	1684PK. 40
1282PK. 29	1351PK. 32	1579PK. 95	1685PK. 40
1284PK. 31	1352PK. 32	1583PK. 73	1686PK. 40
1288PK. 163	1353PK. 32	1584PK. 174	1687PK. 41
1289PK. 162	1354PK. 32	1585PK. 174	1691PK. 42
1292PK. 165	1355PK. 32	1588PK. 155	1695PK. 11
1296PK. 63	1364PK. 33	1589PK. 30	1700PK. 217
1297PK. 55	1365PK. 33	1597PK. 114	1702PK. 217
1302PK. 194	1366PK. 33	1601PK. 50	1703PK. 217
1303PK. 6	1367PK. 33	1603PK. 116	1704PK. 217
1310PK. 96	1368PK. 33	1605PK. 66	1709PK. 218
1313PK. 32	1371PK. 125	1606PK. 50	1709PK10 218
1314PK. 32	1374PK. 202	1607PK. 206	1710PK. 218
1315PK. 32	1379PK. 194	1609PK. 207	1710PK10 218
1316PK. 32	1390PK. 203	1610PK. 62	1711PK. 218
1317PK. 32	1396PK. 235	1614PK. 62	1711PK10 218
1319PK. 33	1399PK. 115	1620PK. 5,16	1712PK. 218
1320PK. 33	1407PK. 57	1621PK. 42	1712PK10 218
1321PK. 33	1410PK. 76	1622PK. 46	1713PK. 218
1322PK. 33	1415PK. 209	1623PK. 4	1713PK10 218
1323PK. 33	1436PK. 174	1624PK. 4	1714PK. 218
1325PK. 33	1446PK. 117	1625PK. 4	1714PK10 218
1326PK. 33	1447PK. 112	1626PK. 4	1715PK. 218
1327PK. 33	1448PK. 112	1634PK. 94	1715PK10 218
1328PK. 33	1466PK. 93	1636PK. 56	1716PK. 143
1329PK. 33	1467PK. 204	1639PK. 47	1722PK. 4
1330PK. 32	1468PK. 4	1640PK. 6	1723PK. 4
1331PK. 32	1469PK. 4	1641PK. 6	1724PK. 4
1332PK. 32	1470PK. 4	1642PK. 6	1725PK. 4
1333PK. 32	1510PK. 49	1644PK. 79	1726PK. 4

Numerical Index

1730PK. 120	1904PK. 212	2056PK. 103	2969ZYPK 51
1734PK. 218	1905PK. 212	2057PK. 102	2970PK. 9
1734PK10 218	1929PK. 87	2060PK. 120	2975PK. 10
1735PK. 218	1930PK. 86	2062PK. 17	2980PK. 59
1735PK10 218	1932PK. 174	2063PK. 146	3010PK. 43
1736PK. 218	1939PK. 17	2065PK. 124	3200PK. 38
1736PK10 218	1943PK. 119	2066PK. 239	3201PK. 38
1737PK. 218	1945PK. 186	2067PK. 239	3202PK. 38
1737PK10 218	1946PK. 186	2068PK. 240	3203PK. 38
1738PK. 218	1949PK. 103	2076PK. 121	3204PK. 38
1738PK10 218	1950PK. 88	2077PK. 121	3205PK. 38
1739PK. 218	1951PK. 210	2080PK. 203	3206PK. 38
1739PK10 218	1964PK. 4	2085PK. 219	3207PK. 38
1740PK. 218	1965PK. 4	2086PK. 219	3208PK. 38
1740PK10 218	1966PK. 4	2087PK. 219	3209PK. 38
1742PK. 145	1967PK. 4	2088PK. 219	3210PK. 38
1756PK. 97	1968PK. 4	2089PK. 219	3211PK. 38
1761PK. 76	1969PK. 4	2090PK. 219	3212PK. 38
1785PK. 218	1970PK. 5	2108PK. 155	3213PK. 38
1786PK. 218	1971PK. 5	2111PK. 86	3214PK. 38
1787PK. 218	1972PK. 118	2112PK. 144	3215PK. 38
1788PK. 218	1973PK. 117	2114PK. 162	3216PK. 38
1789PK. 218	1975PK. 103	2115PK. 161	3217PK. 38
1793PK. 30	1976PK. 118	2121PK. 17	3218PK. 38
1795PK. 7	1991PK. 89	2123PK. 17	3219PK. 38
1796PK. 7	1994PK. 126	2124PK. 18	3220PK. 38
1799PK. 206	1996PK. 93	2128PK. 102	3221PK. 38
1807PK. 143	1997PK. 58	2133PK. 104	3222PK. 38
1810PK. 2	1998PK. 120	2136PK. 21	3600PK. 240
1835PK. 52	1999PK. 114	2142PK. 187	3601PK. 240
1836PK. 52	2002PK. 95	2143PK. 116	3602PK. 240
1842PK. 59	2015PK. 116	2144PK. 153	4002PK. 210
1851PK. 21	2016PK. 90	2145PK. 154	4005PK. 208
1860PK. 104	2017PK. 142	2153PK. 120	4007PK. 209
1861PK. 103	2025PK. 85	2155PK. 116	4008PK. 211
1864PK. 173	2026PK. 111	2156PK. 56	4009PK. 209
1865PK. 86	2027PK. 119	2157PK. 55	4011PK. 158, 211
1888PK. 212	2028PK. 114	2161PK. 185	4014PK. 209
1889PK. 212	2029PK. 141	2163PK. 119	4015PK. 210
1890PK. 212	2034PK. 73	2167PK. 85	4020PK. 141
1891PK. 212	2045PK. 98	2168PK. 164	4040PK. 32
1899PK. 212	2048PK. 80	2194PK. 193	4062PK. 35
1900PK. 212	2050PK. 113	2225PK. 194	4063PK. 35
1901PK. 212	2051PK. 194	2287PK. 207	4064PK. 35
1902PK. 212	2052PK. 194	2940PK. 58	4065PK. 35
1903PK. 212	2053PK. 194	2969PK. 51	4067PK. 35

Numerical Index

4069PK.	35	5618PK.	75	5790PK.	7	6309PK.	3
4070PK.	35	5625PK.	77	5791PK.	8	6310PK.	3
4071PK.	35	5625CPK.	77	5792PK.	8	6311PK.	3
4072PK.	35	5625GYPK.	77	5797PK.	47	6399PK.	3
4074PK.	35	5625WPK.	77	5800PK.	47	6400PK.	3
4084PK.	35	5625CWPK.	77	5805PK.	47	6401PK.	3
4086PK.	35	5625NPK.	77	5895PK.	119	6402PK.	3
4087PK.	35	5627PK.	78	5901PK.	118	6403PK.	3
4088PK.	35	5628PK.	78	5910PK.	47	6404PK.	3
4089PK.	35	5632PK.	78	5915PK.	48	6405PK.	3
4090PK.	35	5635PK.	80	5916XPk.	48	6406PK.	3
4091PK.	35	5640PK.	81	5920PK.	117	6407PK.	3
4094PK.	35	5643PK.	82	5925PK.	13	6408PK.	3
4095PK.	35	5648PK.	83	5930PK.	114	6409PK.	3
4096PK.	35	5650PK.	53	5935PK.	99	6410PK.	3
4098PK.	35	5672PK.	112	5940PK.	104	6411PK.	3
4100PK.	35	5675PK.	98	5950PK.	15	6412PK.	3
4103PK.	35	5676PK.	101	5955PK.	16	7001PK.	12
4105PK.	35	5677PK.	109	5956PK.	16	7002PK.	12
4107PK.	35	5678PK.	110	5970PK.	10	7004PK.	12
4108PK.	35	5680PK.	113	5975PK.	10	7005PK.	13
4112PK.	35	5682PK.	26	5984PK.	8	7006PK.	13
4114PK.	35	5684PK.	26	5989PK.	8	7007PK.	13
4116PK.	35	5686PK.	26	5990PK.	8	7194	220
4125PK.	32	5688PK.	28	5995PK.	82	7194B	221
5264PK.	141	5690PK.	26	6010PK.	7	7194A	221
5412PK.	52	5692PK.	27	6015PK.	195	7211-2	221
5429PK.	76	5695PK.	27	6016PK.	195	7212-2	221
5440PK.	86	5697PK.	28	6018PK.	196	7257	221
5466PK.	52	5698PK.	26	6020PK.	196	7880	230
5480PK.	51	5699PK.	27	6022PK.	196	7886	231
5506PK.	76	5705PK.	27	6185PK.	6	7889	231
5550PK.	14	5710PK.	83	6265PK.	7	7890	231
5552PK.	15	5750PK.	49	6267PK.	7	7891	232
5554PK.	15	5751PK.	49	6293PK.	3	7894	232
5557PK.	54	5752PK.	50	6294PK.	3	7899	232
5558PK.	54	5753PK.	50	6295PK.	3	7906	221
5559PK.	53	5760PK.	5	6296PK.	3	7906A	222
5560PK.	54	5761PK.	5	6299PK.	3	7912	222
5596PK.	53	5762PK.	5	6300PK.	3	7916	222
5602PK.	72	5763PK.	5	6301PK.	3	7916A	222
5605PK.	72	5765PK.	6	6302PK.	3	7921	222
5606PK.	94	5768PK.	202	6303PK.	3	8050	305
5609PK.	74	5769PK.	202	6304PK.	3	8101	248
5610PK.	74	5770PK.	204	6307PK.	3	8101R	248
5614PK.	74	5775PK.	204	6308PK.	3	8105	248

Numerical Index

8109 249	8179 266	8627 283	9132PK. 80
8110 249	8180 267	8627YC. 283	9145PK. 10
8112 250	8181 267	8629 284	9146PK. 10
8115 250	8182 268	8631 285	9147PK. 27
8115R 250	8183 268	8633 286	9160PK. 6
8116 251	8184 269	8633YC. 286	9161PK. 2
8117 251	8185 269	8633X 287	9164PK. 163
8118 252	8500 270	8635 288	9166PK. 20
8119 252	8501 270	8637 289	9168PK. 21
8120 253	8502 271	8637YC. 289	9178PK. 72
8120R 253	8503 271	8639 290	9183PK. 138
8121 253	8504 272	8645 291	9195PK. 84
8122 254	8505 272	8647 292	9197PK. 5
8123 254	8506 273	8649 293	9199PK. 173
8125 255	8507 273	8651 294	9202PK. 119
8126 255	8508 274	8653 295	9205PK. 10
8127 256	8509 274	8655 296	9208PK. 92
8130 256	8510 275	8657 297	9210PK. 20
8130R 256	8511 275	8659 298	9211PK. 3
8131 257	8512 276	8661 299	9213PK. 4
8135 257	8513 276	8663 300	9221PK. 68
8135R 257	8514 277	8665 301	9224PK. 143
8140 258	8515 277	8667 302	9226PK. 45
8140R 258	8516 278	8700 303	9227PK. 5
8145 258	8517 278	8701 304	9233PK. 160
8145R 258	8518 279	8862BPK. 82	9242PK. 141
8146 259	8519 279	9021PK. 145	9243PK. 205
8150 259	8520 280	9046PK. 98	9244PK. 2
8150R 259	8531 285	9050PK. 59	9249PK. 25
8155 260	8539 290	9053PK. 202	9252PK. 3
8161 260	8559 298	9054PK. 203	9256PK. 11
8165 261	8563 300	9064PK. 28	9260PK. 11
8168 261	8601 270	9067PK. 115	9262PK. 94
8169 262	8603 271	9074PK. 93	9264PK. 92
8170 262	8605 272	9081PK. 155	9268PK. 6
8171 263	8607 273	9082PK. 174	9275PK. 29
8172PK. 73	8609 274	9085PK. 55	9277PK. 206
8173 263	8611 275	9101PK. 65	9278PK. 207
8174 264	8613 276	9108PK. 113	9279PK. 217
8174R 264	8615 277	9111PK. 55	9282PK. 110
8175 264	8617 278	9112PK. 56	9287PK. 118
8175R 264	8619 279	9113PK. 58	9292PK. 102
8176 265	8620 280	9114PK. 100	9294PK. 110
8177 265	8623 281	9118PK. 205	9314PK. 28
8177R 265	8625 282	9128PK. 204	9320PK. 97
8178 266	8625YC. 282	9130PK. 78	9325PK. 217

Numerical Index

9327PK. 108	9498PK. 9	9712PK. 67	9797PK. 5
9328PK. 88	9499 244	9718PK. 207	9798PK. 237
9336PK. 92	9500PK. 76	9720PK. 173	9799PK. 238
9339PK. 142	9502PK. 144	9724PK. 217	9800PK. 238
9345PK. 79	9504PK. 126	9725PK. 130	9805PK. 161
9346PK. 5	9507PK. 128	9726PK. 130	9806PK. 34
9352PK. 83	9509PK. 115	9728PK. 130	9807PK. 34
9353PK. 5	9512PK. 53	9729PK. 131	9808PK. 34
9355PK. 67	9513PK. 87	9731PK. 128	9809PK. 175
9357PK. 105	9514PK. 145	9739PK. 34	9812PK. 194
9368PK. 144	9520PK. 81	9740PK. 34	9813PK. 237
9369PK. 99	9522PK. 85	9741PK. 34	9818 166
9370PK. 109	9528PK. 73	9742PK. 34	9819PK. 31
9371PK. 30	9539PK. 148	9743PK. 34	9823PK. 197
9372PK. 147	9540PK. 102	9744PK. 34	9824PK. 38
9373PK. 144	9541PK. 29	9745PK. 99	9825PK. 163
9374PK. 79	9542PK. 31	9749PK. 32	9827PK. 194
9376PK. 80	9543PK. 31	9752PK. 187	9828PK. 194
9379PK. 146	9545PK. 126	9756 197	9829PK. 194
9380PK. 146	9546PK. 125	9757PK. 196	9830PK. 194
9382PK. 110	9547PK. 126	9758PK. 196	9831PK. 194
9384PK. 132	9548PK. 124	9759PK. 31	9832 165
9386PK. 194	9550PK. 126	9763PK. 83	9833 166
9387PK. 194	9554PK. 93	9765PK. 36	9834PK. 237
9390PK. 103	9559PK. 98	9766PK. 36	9836 19
9403PK. 87	9560PK. 91	9767PK. 236	9837 19
9414PK. 75	9561PK. 30	9768PK. 236	9838PK. 19
9417PK. 24	9572PK. 212	9769PK. 235	9839PK. 19
9418PK. 68	9588PK. 86	9770PK. 238	9840PK. 19
9421PK. 159	9591PK. 56	9771PK. 236	9841PK. 5
9437PK. 128	9592PK. 112	9772PK. 238	9842PK. 5
9438PK. 128	9595PK. 164	9773PK. 238	9843PK. 5
9444PK. 148	9596PK. 212	9774PK. 235	9844PK. 194
9446PK. 78	9617PK. 97	9775PK. 237	9847PK. 45
9446NPK. 75	9618PK. 208	9776PK. 237	9848PK. 49
9453PK. 208	9635PK. 159	9777PK. 238	9849PK. 80
9454PK. 205	9636PK. 195	9778PK. 237	9850PK. 42
9465PK. 101	9637PK. 195	9779PK. 239	9852PK. 41
9479PK. 3	9641PK. 20	9780PK. 239	9853PK. 178
9480PK. 3	9644PK. 209	9783PK. 114	9854PK. 203
9485PK. 79	9690PK. 216	9791PK. 5	9856PK. 2
9489PK. 6	9694PK. 121	9792PK. 5	9857PK. 73
9490PK. 6	9695PK. 122	9793PK. 5	9858PK. 99
9493PK. 83	9696PK. 186	9794PK. 5	9859PK. 97
9494PK. 66	9700PK. 12	9795PK. 5	9860PK. 140
9497PK. 9	9709PK. 69	9796PK. 5	9861PK. 140

Numerical Index

9862PK.	141	9909PK.	236	10003PK	20	10077PK	131
9863PK.	72	9912PK.	64	10004PK	20	10078PK	130
9864PK.	96	9913PK.	64	10005PK	20	10079PK	131
9865PK.	6	9914PK.	181	10006PK	20	10080PK	131
9866PK.	48	9915PK.	181	10007PK	20	10081PK	131
9867PK.	24	9934PK.	16	10008PK	20	10082PK	129
9868PK.	24	9937PK.	165	10009PK	20	10083PK	129
9869PK.	15	9939	169	10010PK	20	10084PK	130
9870PK.	2	9940	169	10011PK	20	10090PK	54,140
9871PK.	11	9941PK.	44	10012PK	20	10095PK	20
9872PK.	65	9943PK.	107	10013PK	20	10096PK	12
9873PK.	57	9945PK.	88	10014PK	20	10097PK	25
9874PK.	125	9946PK.	190	10015PK	20	10098PK	147
9875PK.	89	9948	168	10016PK	20	10101PK	4
9876PK.	139	9949PK.	53	10017PK	20	10102PK	4
9877PK.	29	9952PK.	43	10018PK	20	10103PK	4
9878PK.	44	9956	245	10019PK	20	10104PK	4
9879PK.	193	9958PK.	33	10020PK	20	10105PK	4
9880PK.	192	9959PK.	129	10021PK	20	10106PK	173
9881PK.	194	9960PK.	129	10022PK	20	10107.	160
9882PK.	18	9961PK.	132	10023PK	20	10109PK	137
9883PK.	46	9962PK.	132	10024PK	20	10110PK	137
9884PK.	34	9963PK.	132	10025PK	20	10112PK	190
9885PK.	210	9964	168	10026PK	20	10113PK	191
9886PK.	94	9965PK.	161	10027PK	20	10114PK	136
9887PK.	13	9967PK.	180	10028PK	20	10116PK	138
9888PK.	14	9968PK.	115	10029PK	20	10117PK	138
9889PK.	26	9969PK.	180	10030PK	20	10120PK	138
9890PK.	24	9970	34	10031PK	21	10121PK	133
9891PK.	30	9971	34	10032PK	21	10122PK	134
9892PK.	49	9974PK.	195	10033PK	21	10124PK	212
9893PK.	205	9975PK.	195	10034PK	21	10127PK	181
9894PK.	40	9977PK.	95	10035PK	30	10128PK	184
9895PK.	178	9980PK.	85	10052PK	4	10129PK	182
9896PK.	139	9981PK.	129	10053PK	48	10141PK	87
9897PK.	48	9984PK.	31	10056PK	183	10145PK	3
9898PK.	124	9986PK.	129	10058PK	184	10146PK	3
9899PK.	124	9987PK.	128	10059PK	184	10147PK	3
9900PK.	139	9988PK.	133	10060.	167	10148PK	3
9901PK.	96	9989PK.	210	10061PK	162	10149PK	3
9902PK.	209	9990PK.	182	10062PK	162	10150PK	3
9903	16	9991PK.	182	10064PK	76	10151PK	3
9905	167	9992PK.	182	10065.	168	10152PK	3
9906	169	9996PK.	239	10066PK	185	10153PK	3
9907PK.	236	10001PK	20	10075PK	104	10154PK	3
9908PK.	236	10002PK	20	10076PK	131	10155PK	3

Numerical Index

10156PK 3	10203PK 138	10380. 34	10472PK 151
10157PK 4	10210PK 70	10381. 34	10473PK 151
10158PK 4	10211PK 70	10382PK 113	10474PK 152
10159PK 4	10216PK 135	10385PK 21	10475PK 197
10160PK 4	10217PK 136	10388PK 90	10476PK 153
10161PK 4	10223PK 136	10391PK 75	10477PK 157
10162PK 4	10224PK 136	10392PK 190	10478PK 153
10163PK 3	10225PK 133	10393PK 88	10479PK 158
10164PK 3	10226PK 133	10394PK 191	10480PK 181
10165PK 3	10227PK 134	10396PK 188	10481PK 182
10166PK 3	10228PK 134	10397PK 188	10482PK 183
10167PK 3	10229PK 133	10398PK 142	10483PK 185
10168PK 3	10230PK 133	10399PK 140	10484PK 181
10169PK 4	10231PK 135	10403PK 142	10485PK 182
10170PK 4	10232PK 135	10404PK 34	10486PK 185
10171PK 4	10233PK 135	10405PK 154	10487PK 181
10172PK 4	10234PK 135	10407PK 96	10488PK 180
10173PK 4	10235PK 134	10408PK 95	10489PK 180
10174PK 4	10236PK 134	10411PK 94	10490PK 191
10175PK 4	10237PK 134	10412PK 96	10491PK 188
10176PK 4	10238PK 135	10413PK 116	10492PK 191
10177PK 5	10239PK 106	10414PK 96	10493PK 188
10178PK 5	10240PK 69	10415PK 94	10494PK 154
10179PK 5	10241PK 69	10416PK 95	10495PK 143
10180PK 5	10242PK 69	10417PK 95	10496PK 106
10181PK 5	10243PK 69	10421PK 190	10497PK 59
10182PK 5	10244PK 68	10423PK 98	10498PK 62
10183PK 5	10245PK 69	10426PK 64	10499PK 107
10184PK 5	10247PK 107	10429PK 183	10500PK 111
10185PK 5	10277PK 32	10435PK 87	10501PK 90
10186PK 5	10344PK 31	10451PK 164	10502PK 111
10187PK 5	10356PK 108	10455PK 17	10503PK 105
10188PK 5	10357PK 183	10458PK 207	10504PK 105
10189PK 5	10365PK 12	10459PK 208	10505PK 99
10190PK 5	10366PK 78	10460PK 106	10506PK 92
10191PK 5	10367PK 100	10461PK 66	10507PK 206
10192PK 5	10368PK 100	10462PK 79	10508PK 206
10193PK 5	10369PK 100	10463PK 156	10509PK 207
10194PK 5	10370PK 105	10464PK 155	10510PK 208
10195PK 21	10371PK 106	10465PK 156	10511PK 104
10196PK 137	10372PK 107	10466PK 153	10512PK 101
10197PK 137	10374PK 106	10467PK 153	10513PK 91
10198PK 136	10375PK 108	10468PK 115	10514PK 18
10199PK 136	10377PK 111	10469PK 82	10516PK 107
10200PK 137	10378PK 111	10470PK 151	10517PK 81
10201PK 137	10379PK 85	10471PK 151	10518PK 110

Numerical Index

10519PK 111	10567PK 93	10619PK 57	10684PK 14
10520PK 143	10568PK 75	10620PK 63	10685PK 15
10521PK 90	10573PK 150	10621PK 121	10686PK 113
10522PK 109	10574PK 188	10623PK 101	10687PK 150
10523PK 117	10575PK 148	10624PK 119	10690. 197, 245
10524PK 61	10576PK 146	10625PK 109	10691PK 184
10525PK 65	10577PK 90	10628PK 108	10692PK 11
10526PK 67	10578PK 91	10629PK 184	10693PK 14
10527. 167	10579PK 157	10630PK 204	10694PK 14
10528. 166	10580PK 158	10631PK 9	10695PK 15
10529. 152	10581. 157	10632PK 8	10696. 333
10530. 152	10582PK 157	10633PK 174	10697. 333
10531. 152	10583PK 157	10635PK 190	10698. 333
10532. 152	10584. 157	10636PK 60	10699. 170
10533. 152	10585PK 212	10649PK 145	10700PK 138
10534. 153	10586PK 212	10651PK 184	10701PK 151
10535PK 113	10587PK 212	10652PK 73	10703PK 146
10536PK 102	10588PK 212	10653PK 143	10704. 314
10537PK 100	10589PK 212	10655PK 98	10705. 314
10538PK 117	10590PK 212	10656PK 97	10706. 314
10539PK 84	10592PK 212	10657PK 90	10707. 314
10540PK 122	10593PK 212	10659PK 63	10708. 314
10541PK 68	10594PK 212	10660PK 93	10709. 314
10542PK 107	10595PK 212	10661PK 91	10710PK 240
10543PK 142	10596PK 212	10662PK 89	10711PK 240
10544PK 144	10597PK 212	10663PK 91	10712PK 241
10545PK 179	10598PK 212	10664PK 91	10713PK 241
10548PK 60	10599PK 212	10665PK 84	10714PK 112
10549PK 64	10600PK 212	10666PK 109	10715PK 65
10550PK 68	10601PK 212	10667PK 156	10716PK 115
10551PK 64	10602PK 212	10668PK 60	10719PK 144
10552PK 61	10603PK 212	10669PK 105	10723PK 9
10553PK 59	10604PK 212	10670PK 87	10724PK 150
10554PK 62	10605PK 211	10671PK 146	10725PK 9
10555. 18	10606PK 211	10672PK 83	10727PK 126
10556PK 58	10608PK 189	10673PK 105	10728PK 234
10557PK 81	10609PK 189	10674PK 108	10729PK 235
10558. 170	10610PK 148	10675PK 82	10730PK 235
10559. 170	10611PK 81	10676PK 75	10731PK 235
10560PK 203	10612PK 154	10677PK 88	10732PK 51
10561PK 204	10613PK 84	10678PK 57, 121	10734PK 84
10562PK 203	10614PK 116	10679PK 179	10742PK 189
10563PK 205	10615PK 114	10680PK 183	10744PK 151
10564PK 205	10616PK 102	10681PK 109	10745PK 66
10565PK 202	10617PK 67	10682PK 14	10747PK 118
10566PK 84	10618PK 56, 121	10683PK 16	10748PK 155

Numerical Index

10749PK 156	10823PK 179	10911PK 198	11007PK 54
10750PK 190	10824PK 108	10912PK 198	11008PK 54
10751PK 150	10825PK 100	10913PK 185	11009PK 54
10752PK 186	10826PK 189	10914PK 118	11010PK 54
10757PK 6	10827PK 183	10916PK 149	11011PK 54
10763PK 11	10828PK 210	10917PK 156	11012PK 54
10764PK 208	10829PK 218	10918PK 66	11013PK 55
10765PK 206	10830PK 218	10920PK 149	11014PK 55
10766PK 92	10831PK 218	10921PK 192	11015PK 55
10767PK 92	10832PK 218	10922PK 60	11016PK 54
10769PK 187	10833PK 218	10923PK 192	11045PK 214
10770PK 188	10834PK 218	10924PK 148	11046PK 214
10771PK 65	10835PK 218	10925PK 192	11047PK 214
10772PK 61	10838PK 48	10926PK 61	11048PK 214
10773PK 154	10841PK 246	10927PK 150	11049PK 214
10774PK 154	10842PK 246	10928PK 106	11050PK 214
10775PK 65	10843PK 246	10929PK 89	11051PK 214
10776PK 187	10844PK 246	10930PK 149	11052PK 214
10777PK 62	10845PK 246	10931PK 149	11053PK 214
10778PK 175	10880PK 245	10932PK 147	11054PK 214
10779PK 61	10881PK 245	10933PK 149	11055PK 214
10780PK 187	10882PK 245	10934PK 74	11056PK 214
10781PK 67	10884PK 149	10935PK 140	11057PK 214
10782PK 88	10888PK 20	10936PK 191	11058PK 214
10783PK 60	10889PK 198	10937PK 42	11059PK 214
10784PK 187	10890PK 198	10938PK 61	11060PK 214
10785PK 50	10891PK 198	10939PK 155	11061PK 214
10788PK 150	10892PK 198	10940PK 101	11062PK 214
10789PK 189	10893PK 198	10941PK 79	11063PK 214
10790PK 186	10894PK 198	10942PK 64	11064PK 214
10791PK 19	10895PK 198	10943PK 67	11065PK 214
10792 334	10896PK 198	10944PK 89	11066PK 214
10794PK 62	10897PK 198	10945PK 148	11067PK 214
10795PK 52	10898PK 198	10946PK 192	11068PK 214
10796PK 63	10899PK 198	10947PK 147	11069PK 214
10797PK 97	10900PK 198	10948PK 101	11070PK 214
10798PK 103	10901PK 198	10950PK 179	11071PK 214
10799PK 185	10902PK 198	10952PK 156	11072PK 214
10800PK 186	10903PK 198	10953PK 89	11073PK 214
10802PK 179	10904PK 198	10955PK 110	11074PK 214
10803PK 180	10905PK 198	10969PK 175	11075PK 214
10804PK 179	10906PK 198	10970PK 25	11076PK 214
10805PK 180	10907PK 198	10971PK 68	11077PK 214
10806PK 189	10908PK 198	10985PK 196	11078PK 213
10807PK 191	10909PK 198	11005PK 54	11079PK 213
10808PK 56	10910PK 198	11006PK 54	11080PK 213

Numerical Index

11081PK	213	73156.	225	80123B	310
11082PK	213	73156A.	225	80123GC	309
11083PK	213	73157.	225	80123YC	310
11084PK	213	73157A.	225	80132.	311
11085PK	213	73357.	226	80132GC	311
11086PK	213	73357A.	226	80132YC	311
11087PK	213	73457.	226	80133.	312
11088PK	213	73457A.	226	80134.	315
11089PK	213	73496.	226	80320.	312
11090PK	213	73497.	226	80321.	313
11091PK	213	74114K.	227	80323.	311
11092PK	213	74157.	227	80341.	313
11094PK	213	74157K.	227	80352.	309
11095PK	213	74157NAK	227	80353.	314
11096PK	213	77440.	227	80354.	312
11097PK	213	77440A.	227	80356.	314
11098PK	213	77443.	228	D-123PK	120
11099PK	213	77443A.	228	D-124PK	120
11100PK	213	79003.	233	SBB	326
11101PK	213	79004.	233	SB0101.	327
11102PK	213	79005.	233	SB0103.	327
11103PK	213	79006.	234	SB0201.	327
11104PK	213	79007.	234	SB0301.	327
11105PK	213	7D2C	229	SB0304.	328
11106PK	213	7D2R	229	SB0401.	328
11107PK	213	7D2S	229	SB0402.	328
11108PK	213	7H1.	228	SB0403.	328
11109PK	213	7H3.	228	SB0404.	329
11110PK	213	7H4.	228	SB0405.	329
11141PK	18	7H7.	228	SB0601.	329
11408PK	198	7H8.	229	SB0602.	329
71003.	222	7H9.	229	SB0603.	330
71004.	223	7H10	229	SB0801.	330
71141.	223	7H11	230	SB0802.	330
71156.	223	7H13	230	SB0902.	330
71156A.	223	80006.	308	SB0903.	331
71157.	223	80106.	308	SB1001.	331
71157A.	223	80110.	308	SB1002.	331
71893.	224	80112.	308	SB1003.	331
71895.	224	80118.	308	SB1004.	332
72057.	224	80119.	308	JL-23PK	74
72057A.	224	80120.	309	JL-24PK	72
72357.	224	80121.	312	JL-26PK	74
72357A.	224	80122.	310	JL-32PK	72
73057.	225	80123.	309	JL-33PK	82
73057A.	225	80123R.	310	JL-120PK.	81

Inch - Metric Conversion Table

Inches			Inches			Inches			Inches		
Fraction	Decimal	MM	Fraction	Decimal	MM	Fraction	Decimal	MM	Fraction	Decimal	MM
—	.0004	.01	11/32	.34375	8.731	—	.7480	19	1-11/32	1.344	34.131
—	.004	.10	—	.3543	9	3/4	.7500	19.050	1-3/8	1.375	34.925
—	.01	.25	23/64	.35937	9.128	49/64	.7656	19.447	—	1.3779	35
1/64	.0156	.397	—	.374	9.5	25/32	.78125	19.844	1-13/32	1.406	35.719
—	.0197	.50	3/8	.3750	9.525	—	.7874	20	—	1.4173	36
—	.0295	.75	25/64	.3906	9.922	51/64	.79687	20.241	1-7/16	1.438	36.513
1/32	.03125	.794	—	.3937	10	13/16	.8125	20.638	—	1.4567	37
—	.0394	1	13/32	.4062	10.319	—	.8268	21	1-15/32	1.469	37.306
3/64	.0469	1.191	—	.413	10.5	53/64	.8281	21.034	—	1.4961	38
—	.059	1.5	27/64	.42187	10.716	27/32	.84375	21.431	1-1/2	1.500	38.100
1/16	.0625	1.588	—	.4331	11	55/64	.85937	21.828	1-17/32	1.531	38.894
5/64	.0781	1.984	7/16	.4375	11.113	—	.8662	22	—	1.5354	39
—	.0787	2	29/64	.4531	11.509	7/8	.8750	22.225	1-9/16	1.562	39.688
3/32	.094	2.381	15/32	.46875	11.906	57/64	.8906	22.622	—	1.5748	40
—	.0984	2.5	—	.4724	12	—	.9055	23	1-19/32	1.594	40.481
7/64	.1093	2.776	31/64	.48437	12.303	29/32	.90625	23.019	—	1.6142	41
—	.1181	3	—	.492	12.5	59/64	.92187	23.416	1-5/8	1.625	41.275
1/8	.1250	3.175	1/2	.500	12.700	15/16	.9375	23.813	—	1.6535	42
—	.1378	3.5	—	.5118	13	—	.9449	24	1-21/32	1.6562	42.069
9/64	.1406	3.572	33/64	.5156	13.097	61/64	.9531	24.209	1-11/16	1.6875	42.863
5/32	.15625	3.969	17/32	.53125	13.494	31/32	.96875	24.606	—	1.6929	43
—	.1575	4	35/64	.54687	13.891	—	.9843	25	1-21/32	1.719	43.656
11/64	.17187	4.366	—	.5512	14	1	1.000	25.4	—	1.7323	44
—	.177	4.5	9/16	.5625	14.288	—	1.0236	26	1-3/4	1.750	44.450
3/16	.1875	4.763	—	.571	14.5	1-1/32	1.0312	26.194	—	1.7717	45
—	.1969	5	37/64	.57812	14.684	1-1/16	1.062	26.988	1-25/32	1.781	45.244
13/64	.2031	5.159	—	.5906	15	—	1.063	27	—	1.8110	46
—	.2165	5.5	19/32	.59375	15.081	1-3/32	1.094	27.781	1-13/16	1.8125	46.038
7/32	.2187	5.556	39/64	.60937	15.478	—	1.1024	28	1-27/32	1.844	46.831
15/64	.23437	5.953	5/8	.6250	15.875	1-1/8	1.125	28.575	—	1.8504	47
—	.2362	6	—	.6299	16	—	1.1417	29	1-7/8	1.875	47.625
1/4	.2500	6.350	41/64	.6406	16.272	1-5/32	1.156	29.369	—	1.8898	48
—	.2559	6.5	—	.6496	16.5	—	1.1811	30	1-29/32	1.9062	48.419
17/64	.2656	6.747	21/32	.65625	16.669	1-3/16	1.1875	30.163	—	1.9291	49
—	.2756	7	—	.6693	17	1-7/32	1.219	30.956	1-15/16	1.9375	49.213
9/32	.28125	7.144	43/64	.67187	17.066	—	1.2205	31	—	1.9685	50
—	.2953	7.5	11/16	.6875	17.463	1-1/4	1.250	31.750	1-31/32	1.969	50.006
19/64	.29687	7.541	45/64	.7031	17.859	—	1.2598	32	2	2.000	50.800
5/16	.3125	7.938	—	.7087	18	1-9/32	1.281	32.544	—	2.0079	51
—	.3150	8	23/32	.71875	18.256	—	1.2992	33	—	—	—
21/64	.3281	8.334	—	.7283	18.5	1-5/16	1.312	33.338	—	—	—
—	.335	8.5	47/64	.73437	18.653	—	1.3386	34	—	—	—

Disco Automotive Hardware

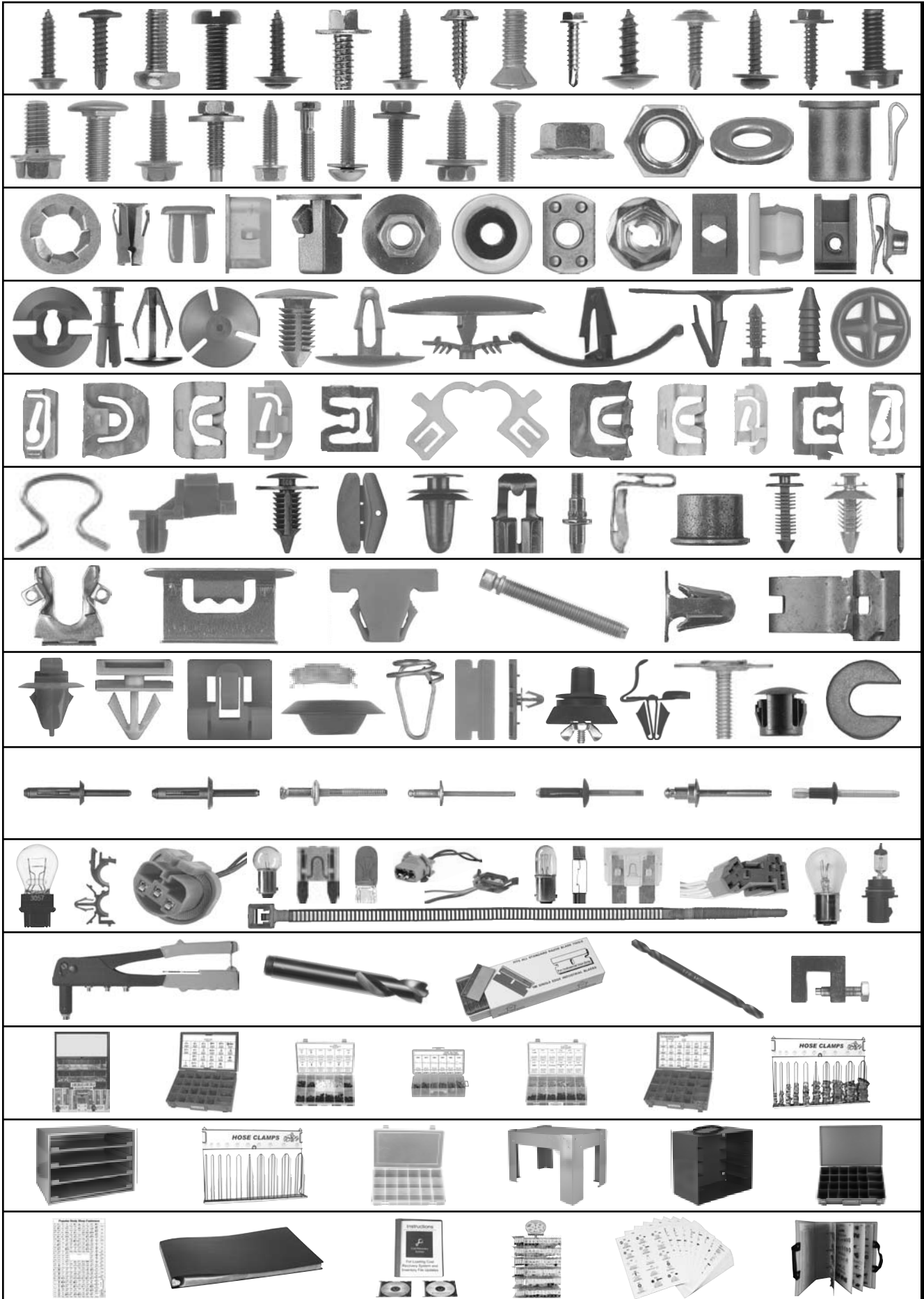

1
2
3
4
5
6
7
8
9
10
11
12
13
14



Screws

9870PK



4-24- x 3/8"
Phillips Flat Head
Moulding Screw Studs
Ford
100 Pcs.

1810PK



(Bright Zinc Finish)

8 x 3/8" 6 Head
3/8" O.D. Washer
Phillips Oval Washer Head
Wheel Opening Moulding Screws
Ford # 381671-S
100 Pcs.

552PK



(Bright Zinc Finish)

8-18 x 7/16"
Phillips Washer Head
9/32" O.D. Head Diameter
Wheel Moulding Screws
G.M. # 4879431
100 Pcs.

9244PK



(Bright Zinc Finish)

8 x 7/16"
3/8" Washer Diameter
Phillips Washer Head
Trim Screws
G.M.
100 Pcs.

9161PK



(Chrome Finish)

4.2-1.41 x 12mm
10mm O.D. Washer
Phillips Pozi-Driv Washer Head
Trim Screws
G.M. # 11501794
100 Pcs.

9856PK



(Chrome Finish)

8 x 5/8"
Phillips Round Washer Head
13/32" Washer O.D.
Trim Screws
G.M.
100 Pcs.



**Phillips Oval Head
Bright Zinc Finish
Sheet Metal Screws**

Part Number	Size	Head Size	Pkg Qty
533PK	6 x 1/2"	# 6	100
534PK	6 x 3/4"	# 6	100
535PK	6 x 1"	# 6	100
10145PK	6 x 1 1/4"	# 6	100
539PK	8 x 1/2"	# 8	100
542PK	8 x 3/4"	# 8	100
545PK	8 x 1"	# 8	100
10146PK	8 x 1 1/4"	# 8	100
10147PK	8 x 1 1/2"	# 8	100
10148PK	8 x 1 3/4"	# 8	100
10149PK	8 x 2"	# 8	100
10150PK	10 x 1/2"	#10	100
555PK	10 x 3/4"	#10	100
557PK	10 x 1"	#10	100
558PK	10 x 1 1/4"	#10	100
559PK	10 x 1 1/2"	#10	100
560PK	10 x 1 3/4"	#10	100
561PK	10 x 2"	#10	100
10151PK	12 x 1/2"	#12	100
10152PK	12 x 3/4"	#12	100
10153PK	12 x 1"	#12	100
10154PK	12 x 1 1/4"	#12	100
10155PK	12 x 1 1/2"	#12	100
10156PK	12 x 2"	#12	100



**Phillips Oval Head
Chrome Finish
Sheet Metal Screws
(Undersized Head)**

Part Number	Size	Head Size	Pkg Qty
6399PK	8 x 3/8"	# 6	100
6400PK	8 x 1/2"	# 6	100
6401PK	8 x 3/4"	# 6	100
6402PK	8 x 1"	# 6	100
6403PK	8 x 1 1/4"	# 6	100
6404PK	8 x 1 1/2"	# 6	100
10163PK	8 x 1 3/4"	# 6	100
10164PK	10 x 1/2"	# 6	100
6405PK	10 x 3/4"	# 6	100
6406PK	10 x 1"	# 6	100
6407PK	10 x 1 1/4"	# 6	100
6408PK	10 x 1 1/2"	# 6	100
10165PK	10 x 1 3/4"	# 6	100
6409PK	10 x 1/2"	# 8	100
6410PK	10 x 3/4"	# 8	100
6411PK	10 x 1"	# 8	100
6412PK	10 x 1 1/4"	# 8	100



**Phillips Oval Head
Black Finish
Sheet Metal Screws
(Undersized Head)**

Part Number	Size	Head Size	Pkg Qty
9479PK	8 x 1/2"	# 6	100
1184PK	8 x 3/4"	# 6	100
1186PK	8 x 1"	# 6	100
9211PK	8 x 1 1/4"	# 6	100
1188PK	8 x 1 1/2"	# 6	100
10166PK	10 x 1/2"	# 8	100
9480PK	10 x 3/4"	# 8	100
9252PK	10 x 1"	# 8	100
10167PK	10 x 1 1/4"	# 8	100
10168PK	10 x 1 1/2"	# 8	100



**Phillips Oval Head
Chrome Finish
Sheet Metal Screws**

Part Number	Size	Head Size	Pkg Qty
6293PK	6 x 1/2"	# 6	100
6294PK	6 x 3/4"	# 6	100
6295PK	6 x 1"	# 6	100
6296PK	6 x 1 1/4"	# 6	100
6299PK	8 x 3/8"	# 8	100
6300PK	8 x 1/2"	# 8	100
6301PK	8 x 3/4"	# 8	100
6302PK	8 x 1"	# 8	100
6303PK	8 x 1 1/4"	# 8	100
6304PK	8 x 1 1/2"	# 8	100
6307PK	10 x 1/2"	#10	100
6308PK	10 x 3/4"	#10	100
6309PK	10 x 1"	#10	100
6310PK	10 x 1 1/4"	#10	100
6311PK	10 x 1 1/2"	#10	100



**Phillips Oval Head
Black Finish
Sheet Metal Screws**

Part Number	Size	Head Size	Pkg Qty
10169PK	6 x 1/2"	# 6	100
10170PK	6 x 3/4"	# 6	100
10171PK	6 x 1"	# 6	100
10172PK	6 x 1 1/4"	# 6	100
1468PK	8 x 1/2"	# 8	100
1183PK	8 x 3/4"	# 8	100
1185PK	8 x 1"	# 8	100
10173PK	8 x 1 1/4"	# 8	100
1187PK	8 x 1 1/2"	# 8	100
10174PK	10 x 1/2"	#10	100
1469PK	10 x 3/4"	#10	100
1470PK	10 x 1"	#10	100
10175PK	10 x 1 1/4"	#10	100
10176PK	10 x 1 1/2"	#10	100



**Phillips Pan Head
Black Finish
Sheet Metal Screws**

Part Number	Size	Pkg Qty
10101PK	6 x 1/2"	100
10102PK	6 x 3/4"	100
10103PK	6 x 1"	100
10104PK	6 x 1 1/4"	100
1623PK	8 x 1/2"	100
1624PK	8 x 3/4"	100
1625PK	8 x 1"	100
10105PK	8 x 1 1/4"	100
1626PK	8 x 1 1/2"	50
1722PK	10 x 1/2"	100
1723PK	10 x 3/4"	100
1724PK	10 x 1"	50
1725PK	10 x 1 1/4"	50
1726PK	10 x 1 1/2"	50



**Phillips Pan Head
Bright Zinc Finish
Sheet Metal Screws**

Part Number	Size	Pkg Qty
10157PK	6 x 1/2"	100
485PK	6 x 3/4"	100
486PK	6 x 1"	100
487PK	6 x 1 1/4"	100
489PK	8 x 1/2"	100
492PK	8 x 3/4"	100
493PK	8 x 1"	100
10052PK	8 x 1 1/4"	100
494PK	8 x 1 1/2"	100
495PK	10 x 1/2"	100
496PK	10 x 3/4"	100
497PK	10 x 1"	100
10158PK	10 x 1 1/4"	100
498PK	10 x 1 1/2"	100
499PK	12 x 1/2"	100
500PK	12 x 3/4"	100
501PK	12 x 1"	100
10159PK	12 x 1 1/4"	100
10160PK	12 x 1 1/2"	100
502PK	14 x 1/2"	100
503PK	14 x 3/4"	100
504PK	14 x 1"	100
10161PK	14 x 1 1/4"	100
10162PK	14 x 1 1/2"	100
505PK	14 x 1 3/4"	100
506PK	14 x 2"	100
9213PK	14 x 2 1/2"	50



**Phillips Pan Head
Bright Zinc Finish
Teks® Screws**

Part Number	Size	Pkg Qty
1964PK	8 x 1/2"	100
1965PK	8 x 3/4"	100
1966PK	8 x 1"	100
1967PK	10 x 1/2"	100
1968PK	10 x 3/4"	100
1969PK	10 x 1"	100



**Indented Hex Head
Bright Zinc Finish
Tek® Screws**

Part Number	Size	Hex Size	Pkg Qty
1077PK	8 x 1/2"	1/4"	100
1078PK	8 x 3/4"	1/4"	100
9791PK	8 x 1"	1/4"	100
9792PK	8 x 1 1/4"	1/4"	50
9353PK	8 x 1 1/2"	1/4"	50
9841PK	10 x 1/2"	5/16"	100
1079PK	10 x 5/8"	5/16"	100
9346PK	10 x 3/4"	5/16"	100
1080PK	10 x 1"	5/16"	100
9793PK	10 x 1 1/4"	5/16"	50
9794PK	10 x 1 1/2"	5/16"	50
9843PK	12 x 3/4"	5/16"	100
9795PK	12 x 1"	5/16"	25
9796PK	12 x 1 1/4"	5/16"	25
1970PK	14 x 3/4"	3/8"	100
1971PK	14 x 1"	3/8"	25
9797PK	14 x 1 1/4"	3/8"	25
9842PK	14 x 1 1/2"	3/8"	25



**Slotted Indented Hex
Washer Head Bright Zinc Finish
Sheet Metal Screws**

Part Number	Size	Head Size	Pkg Qty
10177PK	6 x 1/2"	1/4"	100
10178PK	6 x 3/4"	1/4"	100
10179PK	8 x 1/2"	1/4"	100
10180PK	8 x 3/4"	1/4"	100
10181PK	8 x 1"	1/4"	100
10182PK	8 x 1 1/4"	1/4"	100
10183PK	10 x 1/2"	5/16"	100
10184PK	10 x 3/4"	5/16"	100
10185PK	10 x 1"	5/16"	100
10186PK	10 x 1 1/4"	5/16"	100
10187PK	10 x 1 1/2"	5/16"	100
10188PK	12 x 1/2"	5/16"	100
10189PK	12 x 3/4"	5/16"	100
10190PK	12 x 1"	5/16"	100
10191PK	12 x 1 1/4"	5/16"	100
10192PK	12 x 1 1/2"	5/16"	100
1620PK	14 x 3/4"	3/8"	50
10193PK	14 x 1"	3/8"	50
10194PK	14 x 1 1/4"	3/8"	50

9227PK



(Bright Zinc Finish)

8 x 1/2"
1/4" Hex Head Slotted
Indented Hex Washer Head
Pierce Point Sheet Metal Screws
G.M.
100 Pcs.



**Phillips Oval Head
Loose Washer
Chrome Finish
Sems® Countersunk
Trim Screws
(Washer Design Will Not Cut Into Pads)**

Part Number	Size	Head Size	Pkg Qty
5760PK	8 x 3/4"	# 6	100
5761PK	8 x 1"	# 6	100
9197PK	8 x 1 1/4"	# 6	100
5762PK	10 x 3/4"	# 8	100
5763PK	10 x 1"	# 8	100

1



**Phillips Oval Head
Loose Washer
Black Finish
Sems® Countersunk
Trim Screws**

(Washer Design Will Not Cut Into Pads)

Part Number	Size	Head Size	Pkg Qty
9865PK	8 x 5/8"	# 6	100
1640PK	8 x 3/4"	# 6	100
1641PK	8 x 1"	# 6	100
9489PK	10 x 3/4"	# 8	50
9490PK	10 x 1"	# 8	50

9160PK



(Black Finish)

**8 x 3/4"
13/32" O.D. Washer Head
Phillips Oval Washer Head
Trim Screws
G.M. # 11501884
100 Pcs.**



**Phillips Oval Head
Loose Washer
Black Finish
Sems® Countersunk
Teks® Trim Screws**

(Washer Design Will Not Cut Into Pads)

Part Number	Size	Head Size	Pkg Qty
1303PK	8 x 3/4"	# 6	100
1642PK	8 x 1"	# 6	50
10757PK	8 x 1 1/4"	# 6	50

5765PK



(Bright Zinc Finish)

**8 x 1/2"
7/16" O.D. Washer Head
Phillips Oval Washer Head
Wheel Opening Mldg. Teks® Screws
G.M. # 1689827
50 Pcs.**

9268PK



**8 Screw Size
Countersunk Type
Nickel Plated Steel
Finish Washer
G.M.
100 Pcs.**

6185PK



(Chrome Finish)

**8 x 1/2"
7/16" O.D. Washer Head
Phillips Oval Washer Head
Wheel Opening Mldg. Teks® Screws
G.M.
50 Pcs.**

6010PK



(Black Finish)

8 x 1/2"
7/16" O.D. Washer Head
Phillips Oval Washer Head
Wheel Opening Mldg. Teks® Screws
G.M. # 20423550
50 Pcs.

6265PK



(Black Finish)

8 x 3/4"
7/16" O.D. Washer Head
Phillips Oval Washer Head
Mounting Teks® Screws
G.M.
50 Pcs.

6267PK



(Black Finish)

8 x 1"
7/16" O.D. Washer Head
Phillips Oval Washer Head
Mounting Teks® Screws
G.M.
50 Pcs.

5790PK



(Bright Zinc Finish)

8 x 1/2"
13/32" O.D. Washer Head
Phillips Flat Top Washer Head
Trim Screws
Chrysler # 9422202
100 Pcs.

1795PK



(Bright Zinc Finish)

8 x 3/4"
13/32" O.D. Washer Head
Phillips Flat Top Washer Head
Trim Screws
Chrysler
100 Pcs.

1796PK



(Bright Zinc Finish)

8 x 1"
13/32" O.D. Washer Head
Phillips Flat Top Washer Head
Trim Screws
Chrysler
100 Pcs.

5791PK



(Black Finish)

8 x 1/2"
13/32" O.D. Washer Head
Phillips Flat Top Washer Head
Trim Screws
G.M. # 11505104
100 Pcs.

5792PK



(Black Finish)

8 x 5/8"
13/32" O.D. Washer Head
Phillips Flat Top Washer Head
Trim Screws
G.M.
100 Pcs.

5984PK



(Black Finish)

8 x 3/4"
13/32" O.D. Washer Head
Phillips Flat Top Washer Head
Trim Screws
G.M.
100 Pcs.

5989PK



(Black Finish)

8 x 1"
13/32" O.D. Washer Head
Phillips Flat Top Washer Head
Trim Screws
G.M.
100 Pcs.

5990PK



(Black Finish)

8 x 1 1/4"
13/32" O.D. Washer Head
Phillips Flat Top Washer Head
Trim Screws
G.M.
50 Pcs.

10632PK



(Black Finish)

8 x 1 1/2"
13/32" O.D. Washer Head
Phillips Flat Top Washer Head
Trim Screws
G.M.
50 Pcs.

10723PK



(Black Finish)

10 x 1/2"
15/32" O.D. Washer Head
Phillips Flat Top Washer Head
Trim Screws
Chrysler # 9423950
100 Pcs.

9497PK



(Black Finish)

10 x 3/4"
15/32" O.D. Washer Head
Phillips Flat Top Washer Head
Trim Screws
G.M.
50 Pcs.

9498PK



(Black Finish)

10 x 1"
15/32" O.D. Washer Head
Phillips Flat Top Washer Head
Trim Screws
G.M.
50 Pcs.

10631PK



(Black Finish)

10 x 1 1/4"
15/32" O.D. Washer Head
Phillips Flat Top Washer Head
Trim Screws
G.M.
50 Pcs.

10725PK



(Black Finish)

8 x 1/2"
1/2" O.D. Washer Head
Phillips Flat Top Washer Head
Trim Screws
Ford
100 Pcs.

2970PK



(Black Finish)

8 x 3/4"
1/2" O.D. Washer Head
Phillips Flat Top Washer Head
Trim Screws
Ford # 56912-S2
100 Pcs.

1

2975PK



(Black Finish)

8 x 1"
1/2" O.D. Washer Head
Phillips Flat Top Washer Head
Trim Screws
Ford # 56914-S2
100 Pcs.

9205PK



(Black Finish)

10 x 1/2"
1/2" O.D. Washer Head
Phillips Flat Top Washer Head
Trim Screws
Ford
100 Pcs.

9145PK



(Black Finish)

10 x 3/4"
1/2" O.D. Washer Head
Phillips Flat Top Washer Head
Trim Screws
Ford
50 Pcs.

9146PK



(Black Finish)

10 x 1"
1/2" O.D. Washer Head
Phillips Flat Top Washer Head
Trim Screws
Ford
50 Pcs.

5970PK



(Black Heavy Phosphate Finish)

8 x 3/4"
1/2" O.D. Washer Head
Phillips Flat Top Washer Head
Trim Screws
Ford # 56912-S2
100 Pcs.

5975PK



(Black Heavy Phosphate Finish)

8 x 1"
1/2" O.D. Washer Head
Phillips Flat Top Washer Head
Trim Screws
Ford
100 Pcs.

1695PK



(Black Finish)

4.2 x 13mm
11mm O.D. Washer Head
Phillips Oval Washer Head
Trim Screws
G.M. # 11505104
50 Pcs.

10763PK



(Black Finish)

4.8-1.61 x 16mm
14mm O.D. Washer Head
Phillips Truss Head
Sheet Metal Screws
Hyundai
100 Pcs.

9256PK



(Black Finish)

4.8-1.6 x 15mm
14mm O.D. Washer Head
Phillips Truss Head
Sheet Metal Screws
G.M.
50 Pcs.

10692PK



(Black Finish)

4.8-2.12 x 20mm
14mm O.D. Washer Head
Phillips Truss Head
Sheet Metal Screws
Nissan
50 Pcs.

9260PK



(Black Finish)

6.3-1.81 x 16mm
15mm O.D. Washer Head
Phillips Truss Head
Sheet Metal Screws
G.M.
50 Pcs.

9871PK



(Black Finish)

8 x 3/4"
1/2 " O.D. Loose Washer
Phillips Pan Head
Sheet Metal Screws
Ford
50 Pcs.

1

10365PK

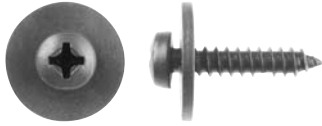

(Black Finish)

4.2-1.41 x 20mm
16mm O.D. Loose Washer
Phillips Pan Head L/Washer
Sheet Metal Screws
Ford # N801603-S61
50 Pcs.

10096PK

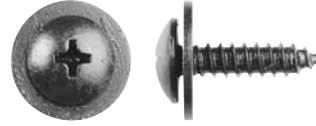

(Black Finish)

4.8-1.60 x 19mm
16mm O.D. Loose Washer
Phillips Truss L/Washer Head
Trim Screws
Honda # 90114-SE0-000
25 Pcs.

9700PK



(Black Finish)

8 x 3"
Phillips Bugle Head
Course Thread
Dry Wall Screws
50 Pcs.

7002PK



(Chrome Finish)

4.2-1.41 x 20mm
7mm Oval Head
Stainless Steel
Metric Torx® Trim Screws
G.M. # 11504069
50 Pcs.

7004PK



(Chrome Finish)

4.2-1.41 x 30mm
7mm Oval Head
Stainless Steel
Metric Torx® Trim Screws
G.M. # 11504522
50 Pcs.

7001PK



(Black Finish)

4.2-1.41 x 20mm
7mm Oval Head
Stainless Steel
Metric Torx® Trim Screws
G.M. # 11504659
50 Pcs.

7005PK



(Black Finish)

4.2-1.41 x 30mm
7mm Oval Head
Stainless Steel
Metric Torx® Trim Screws
G.M. # 11504656
50 Pcs.

7006PK



(Chrome Finish)

4.2-1.41 x 25mm
8mm Pan Head
Stainless Steel
Metric Torx® Trim Screws
G.M. # 11504661
50 Pcs.

7007PK



(Black Finish)

4.2-1.41 x 25mm
8mm Pan Head
Stainless Steel
Metric Torx® Trim Screws
G.M. # 11504662
50 Pcs.

511PK



(Bright Zinc Finish)

10 x 1 1/2"
5/16" Hex Head
Sheet Metal Screws
(Used in Body Pulling Tools)
G.M.
100 Pcs.

9887PK



(Black Finish)

4.2-1.41 x 16mm
7mm Indented Hex Head
12mm O.D. Loose Washer
Sheet Metal Screws
G.M. # 11503395
100 Pcs.

5925PK



(Black Finish)

4.2-1.41 x 20mm
12mm O.D. Loose Washer
7mm Indented Hex Head
Sheet Metal Screws
G.M. # 11503396
50 Pcs.

1

5550PK



(Black Finish)

4.2-1.41 x 20mm
17mm O.D. Loose Washer
7mm Indented Hex Head
Sheet Metal Screws
G.M. # 11503892
50 Pcs.

9888PK



(Black Finish)

4.2-1.41 x 20mm
12mm O.D. Loose Washer
7mm Indented Head Head
Sheet Metal Screws
G.M. # 11504056
50 Pcs.

10684PK



(Black Finish)

4.2-1.41 x 30mm
17mm O.D. Loose Washer
7mm Hex Size
Hex Head Sems Screws
Ford # N811534-S61
15 Pcs.

10693PK

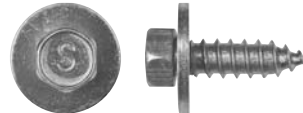

(Yellow Zinc Finish)

5.5-1.81 x 18mm
15mm O.D. Loose Washer
8mm Hex Size
Hex Head Sems Screws
Imports
50 Pcs.

10682PK

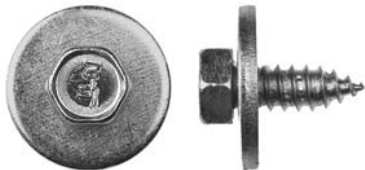

(Yellow Zinc Finish)

6.3-1.81 x 18mm
22mm O.D. Loose Washer
10mm Hex Size
Hex Head Sems Screws
Honda, Nissan, Toyota
25 Pcs.

10694PK



(Black Finish)

6.3-1.81 x 20mm
16mm O.D. Loose Washer
10mm Hex Head Phillips
Hex Head Sems Screws
Imports
50 Pcs.

5554PK



(Black Finish)

4.2-1.41 x 20mm
12mm O.D. Loose Washer
7mm Indented Hex Head
Teks® Screws
G.M.
50 Pcs.

5552PK



(Black Finish)

4.2-1.41 x 20mm
17mm O.D. Loose Washer
7mm Indented Hex Head
Teks® Screws
G.M.
50 Pcs.

10685PK



(Yellow Zinc Finish)

10 x 3/4"
19/32" O.D. Loose Washer
5/16" Hex Size
Hex Head Sems Screws
Honda, Nissan, Toyota
50 Pcs.

9869PK



(Bright Zinc Finish)

14 x 3/4"
5/8" O.D. Loose Washer
3/8" Indented Hex Head
Sheet Metal Screws
G.M.
100 Pcs.

10695PK

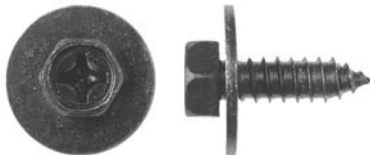

(Black Finish)

6.3-1.81 x 20mm
20mm O.D. Loose Washer
10mm Hex Head Phillips
Hex Head Sems Screws
Imports
50 Pcs.

5950PK



(Black Finish)

6.3-1.81 x 20mm
17mm O.D. Loose Washer
10mm Indented Hex Washer Head
Sheet Metal Screws
G.M. # 11505022
50 Pcs.

1

10683PK

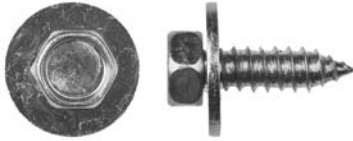

(Yellow Zinc Finish)

6.3-1.81 x 20mm
18mm O.D. Loose Washer
10mm Hex Size
Hex Head Sems Screws
Honda, Nissan, Toyota
25 Pcs.

5955PK

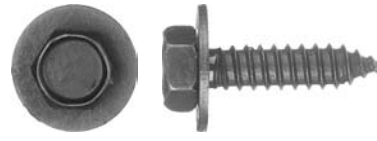

(Black Finish)

6.3-1.81 x 25mm
11/16" O.D. Loose Washer
10mm Indented Hex Head
Sheet Metal Screws
G.M. # 11500996
50 Pcs.

5956PK



(Black Phosphate Finish)

6.3-1.81 x 25mm
24mm O.D. Loose Washer
10mm Indented Hex Head
Sheet Metal Screws
G.M. # 11507083
25 Pcs.

1620PK



(Bright Zinc Finish)

1/4" (14) x 3/4"
1/2" O.D. Washer Head
3/8" Indented Hex Head Slotted
License Plate Screws
G.M.
50 Pcs.

9903



1/4" (14) x 3/4"
1/2" O.D. Washer Head
3/8" Indented Hex Head Slotted
License Plate Screw
and Nylon Nut
G.M.
25 Pcs.

9934PK



(Black Finish)

1/4" (14) x 3/4"
1/2" O.D. Washer Head
3/8" Indented Hex Head Slotted
License Plate Screws
G.M.
50 Pcs.

2123PK



(Yellow Zinc Finish)

1/4" (14) X 3/4"
1/2" O.D. Washer Head
10mm Indented Hex Head Phillips
License Plate Screws
Honda # 91500-SM4-999AH
50 Pcs.

1939PK

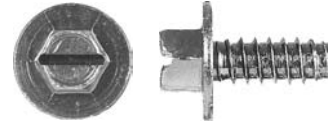

(Black Finish)

1/4" (14) x 5/8"
5/8" O.D. Washer
5/16" Indented Hex Head Slotted
License Plate Screws
Ford # N800369-S2
50 Pcs.

477PK



(Bright Zinc Finish)

1/4" (14) x 3/4"
9/16" Head Diameter
Slotted Truss Head
License Plate Screws
Ford
100 Pcs.

2062PK



(Black Finish)

1/4" (14) x 3/4"
9/16" Head Diameter
Slotted Truss Head
License Plate Screws
Ford
100 Pcs.

2121PK



(Bright Zinc Finish)

1/4" (14) x 3/4"
9/16" Head Diameter
Phillips Truss Head
License Plate Screws
Ford
50 Pcs.

10455PK



(Silver Dacromet Finish)

6.3-1.81 x 16mm
Duo Drive Truss Head
License Plate Screws
G.M. # 9423101
50 Pcs.

1

10514PK

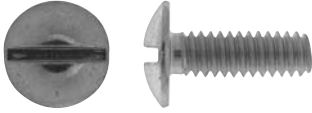

(Bright Zinc Finish)

1/4-20 x 3/4"
9/16" Head Diameter
Slotted Truss Head
License Plate Screws
G.M.
100 Pcs.

11141PK

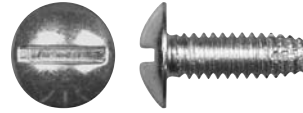

(Bright Zinc Finish)

1/4-20 x 3/4"
Truss Head Slotted
Type F Point
License Plate Screws
50 Pcs.

10555



1/4-20 x 3/4"
9/16" Head Diameter
Slotted Truss Head
License Plate Screw and Nylon Nut
G.M.
50 Pcs. Each

1650PK



1/4" (14) x 1/2"
1 1/8" Overall Length
Dealer License Plate
Thumb Screws
G.M.
25 Pcs.

2124PK



(Bright Zinc Finish)

6 -1.00 x 16mm
10mm Hex Size
Hex Washer Head Slotted
License Plate Screws
G.M.
50 Pcs.

9882PK



(Black Nylon)

1/4-20 x 5/8"
Truss Slot Washer Head
License Plate Screws
G.M.
50 Pcs.

9839PK



(Black Nylon)

6-1.00 x 16mm
Pan Head Slotted
License Plate Screws
G.M.
100 Pcs.

9840PK



(Black Nylon)

6-1.00 x 20mm
Pan Head Slotted
License Plate Screws
G.M.
100 Pcs.

9838PK



(Black Nylon)

6-1.00mm
10mm Hex Size
Hex Nuts
G.M.
100 Pcs.

9836



(Black Nylon)

6 -1.00 x 16mm
Slotted Screw with Hex Nuts
License Plate Screw Kits
G.M.
50 Pcs.

9837



(Black Nylon)

6 -1.00 x 20mm
Screw with Hex Nuts
License Plate Screw Kits
G.M.
50 Pcs.

10791PK

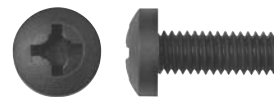

(Black Nylon)

6-1.00 x 16mm
Pan Head Phillips
License Plate Screws
G.M.
100 Pcs.

10095PK



(Black Nylon)

6-1.00 x 20mm
Pan Head Phillips
License Plate Screws
G.M.
100 Pcs.

10888PK

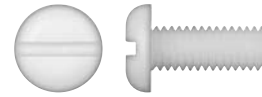

(Natural Nylon)

6-1.00 x 16mm
Pan Head Slotted
License Plate Screws
100 Pcs.

9210PK



(Bright Zinc Finish)

1/4-20 x 3/4"
Phillips Oval Head
Machine Screws
G.M.
50 Pcs.



**Phillips Pan Head
Bright Zinc Finish Machine Screws**

Part Number	Size	Pkg Qty
10001PK	6-32 x 3/8"	100
10002PK	6-32 x 1/2"	100
10003PK	6-32 x 3/4"	100
10004PK	6-32 x 1"	100
10005PK	6-32 x 1 1/4"	100
10006PK	6-32 x 1 1/2"	100
10007PK	8-32 x 3/8"	100
10008PK	8-32 x 1/2"	100
10009PK	8-32 x 3/4"	100
10010PK	8-32 x 1"	100
10011PK	8-32 x 1 1/2"	100
10012PK	10-24 x 3/8"	100
10013PK	10-24 x 1/2"	100
10014PK	10-24 x 3/4"	100
10015PK	10-24 x 1"	100
10016PK	10-24 x 1 1/4"	100
10017PK	10-24 x 1 1/2"	50
10018PK	10-32 x 3/8"	100
10019PK	10-32 x 1/2"	100
10020PK	10-32 x 3/4"	100
10021PK	10-32 x 1"	100
10022PK	10-32 x 1 1/4"	100
10023PK	10-32 x 1 1/2"	50
10024PK	1/4-20 x 1/2"	100
10025PK	1/4-20 x 3/4"	100
9166PK	1/4-20 x 7/8"	100
10026PK	1/4-20 x 1"	50
10027PK	1/4-20 x 1 1/4"	50
10028PK	1/4-20 x 1 1/2"	50
10029PK	1/4-20 x 1 3/4"	50
10030PK	1/4-20 x 2"	50

9641PK



(Bright Zinc Finish)

1/4-20 X 1 1/4"
Phillips Oval Head
Machine Screws
G.M.
50 Pcs.



**Phillips Pan Head
Zinc Finish
Machine Screws
Din # 7985**

Part Number	Size	Pkg Qty
10385PK	5-.80 x 16mm	100
10195PK	5-.80 x 16mm	100
2136PK	6-1.0 x 12mm	100
1851PK	6-1.0 x 16mm	50
9168PK	6-1.0 x 20mm	50

10031PK



(Bright Zinc Finish)

**8 x 3/4"
Phillips Cap Type
Trim Screws
Used with # 10032
100 Pcs.**

10032PK



**3/8" O.D.
Black Nylon
Screw Caps
Used with # 10031
100 Pcs.**

485PK



(Bright Zinc Finish)

**6 x 3/4"
Phillips Pan Head
Sheet Metal Screws
100 Pcs.**

10034PK



**Install with a 6 Screw
Clear Nylon
Screw Bases
Used with # 10033
50 Pcs.**

10033PK



**1/2" O.D.
Black Nylon
Screw Caps
Used with # 10034
50 Pcs.**

1



Standard & Metric Fasteners

2

204PK

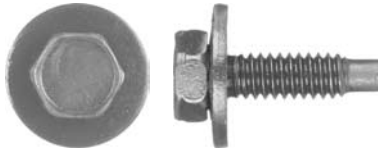

1/4-20 x 15/16"
3/4" O.D. Loose Washer
7/16" Indented Hex Head
Black Finish
Dog Point Body Bolts
Ford # 57030-S2
50 Pcs.

9417PK



1/4-20 x 1"
5/8" O.D. Loose Washer
7/16" Indented Hex Head
Black Finish
Dog Point Body Bolts
Chrysler # 6025329
50 Pcs.

9867PK



5/16-18 x 3/4"
13/16" O.D. Flange Size
1/2" Hex Size
Black Finish
Dog Point Spin Lock Bolts
G.M.
100 Pcs.

210PK



5/16-18 x 13/16"
21/32" O.D. Flange Size
1/2" Indented Hex Head
Black Finish
Type CA Body Bolts
G.M. # 3960314
50 Pcs.

9868PK



5/16-18 x 1"
13/16" O.D. Flange Size
1/2" Hex Size
Black Finish
Dog Point Spin Lock Bolts
G.M.
50 Pcs.

9890PK

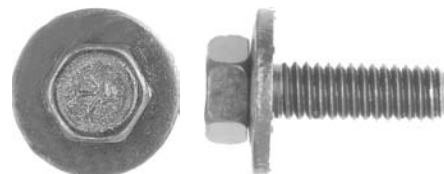

5/16-18 x 1"
7/8" O.D. Loose Washer
1/2" Indented Hex Head
Black Finish
Body Bolts
G.M.
100 Pcs.

9249PK

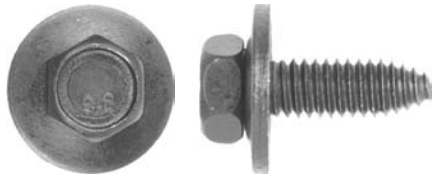

5/16-18 x 1"
 7/8" O.D. Loose Washer
 1/2" Indented Hex Head
 Black Finish
 Type CA Body Bolts
 G.M.
 25 Pcs.

206PK

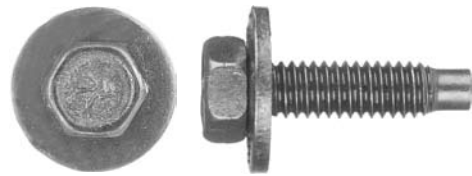

5/16-18 x 1 3/16"
 7/8" O.D. Loose Washer
 1/2" Indented Hex Head
 Black Finish
 Dog Point Body Bolts
 Ford # 57041-S2
 25 Pcs.

1000PK

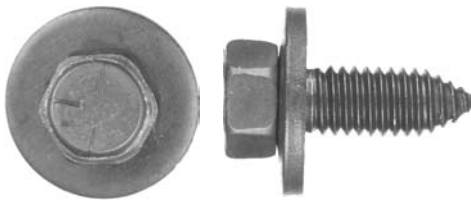

3/8-16 x 1"
 1" O.D. Loose Washer
 9/16" Indented Hex Head
 Black Finish
 Type CA Body Bolts
 G.M. # 3986997
 25 Pcs.

1001PK

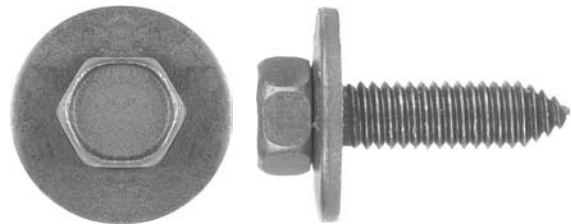

3/8-16 x 1 1/2"
 1 1/8" O.D. Loose Washer
 9/16" Indented Hex Head
 Black Finish
 Type CA Body Bolts
 G.M. # 407217
 25 Pcs.

10970PK



5-.80 x 20mm
 12mm O.D. Loose Washer
 8mm Hex Size
 Black Finish
 Metric Dog Point Body Bolts
 Chrysler # 6100539
 50 Pcs.

10097PK

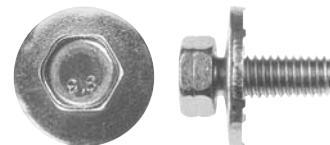

6-1.00 x 16mm
 18.5mm O.D. Loose Washer
 10mm Indented Hex Head
 Zinc and Yellow Finish
 Metric Body Bolts
 G.M. # 11503812
 50 Pcs.

5682PK



6-1.00 x 20mm
13mm O.D. Flange Size
10mm Indented Hex Head
Black Finish
Metric Type CA Flange Bolts
G.M. # 11503800
50 Pcs.

9889PK

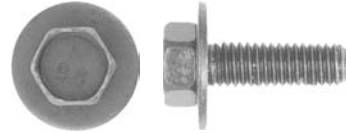

6-1.00 x 20mm
17mm O.D. Flange Size
10mm Indented Hex Head
Black Finish
Metric Body Bolts
G.M. # 11504570
50 Pcs.

5684PK



6-1.00 x 20mm
17mm O.D. Loose Washer
10mm Indented Hex Head
Black Finish
Metric Type CA Body Bolts
G.M. # 11502941
50 Pcs.

5698PK



6-1.00 x 22mm
19mm O.D. Loose Washer
8mm Indented Hex Head
Black Finish
Metric Dog Point Body Bolts
Ford # N606676-S2
25 Pcs.

5686PK



6-1.00 x 25mm
17mm O.D. Loose Washer
10mm Indented Hex Head
Black Finish
Metric Type CA Body Bolts
G.M. # 11503834
50 Pcs.

5690PK

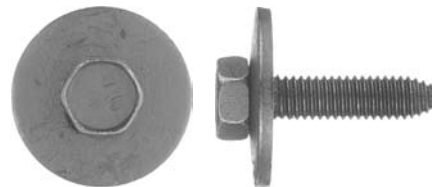

6-1.00 x 25mm
24mm O.D. Loose Washer
10mm Indented Hex Head
Black Finish
Metric Type CA Body Bolts
G.M. # 11503982
50 Pcs.

5699PK

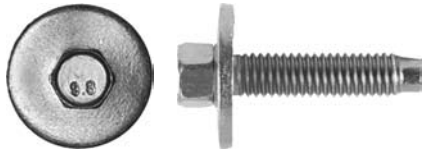

6-1.00 x 28mm
19mm O.D. Loose Washer
8mm Indented Hex Head
Zinc and Yellow Finish
Metric Dog Point Body Bolts
Ford # N606677-S36
25 Pcs.

5705PK



6-1.00 x 28mm
19mm O.D. Loose Washer
8mm Indented Hex Head
Black Finish
Metric Dog Point Body Bolts
Ford # N606677-S
25 Pcs.

5692PK



6-1.00 x 35mm
17mm O.D. Loose Washer
10mm Indented Hex Head
Black Finish
Metric Type CA Body Bolts
G.M. # 11505044
50 Pcs.

1013PK

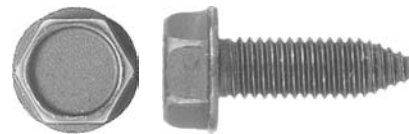

8-1.25 x 25mm
16mm O.D. Flange Size
13mm Indented Hex Head
Black Finish
Metric Type CA Body Bolts
G.M. # 11500970
25 Pcs.

9147PK



8-1.25 x 25mm
24mm O.D. Loose Washer
13mm Indented Hex Head
Black Finish
Metric Type CA Body Bolts
G.M. # 11503619
25 Pcs.

5695PK



8-1.25 x 30mm
17mm O.D. Flange Size
13mm Indented Hex Head
Zinc Finish
Metric Type CA Body Bolts
G.M.
25 Pcs.

5688PK

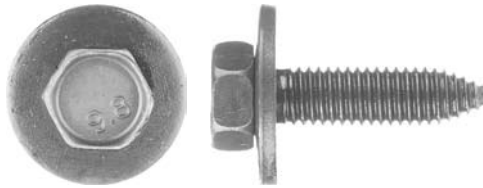

8-1.25 x 30mm
24mm O.D. Loose Washer
13mm Indented Hex Head
Black Finish
Metric Type CA Body Bolts
G.M. # 11501188
25 Pcs.

5697PK



8-1.25 x 30mm
17mm O.D. Flange Size
13mm Indented Hex Head
Black Finish
Metric Type CA Body Bolts
G.M. # 11500971
25 Pcs.

9064PK

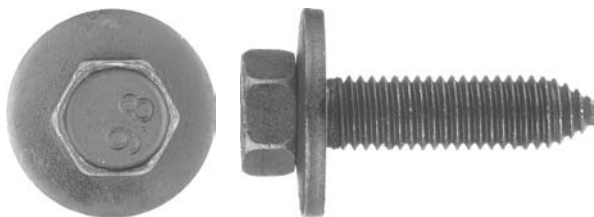

10-1.50 x 40mm
28mm O.D. Loose Washer
15mm Indented Hex Head
Black Finish
Metric Type CA Body Bolts
G.M. # 11501193
25 Pcs.

240PK



5/16-18 x 1"
3/4" Head Diameter
Round Style Head
Stainless Steel Capped
Bumper Bolts
G.M.
25 Pcs.

855PK



3/8-16 x 1"
7/8" Head Diameter
Pan Style Head
Stainless Steel Capped
Bumper Bolts
Chrysler # 6026723
25 Pcs.

9314PK



3/8-16 x 1 1/4"
7/8" Head Diameter
Round Style Head
Stainless Steel Capped
Bumper Bolts
G.M.
25 Pcs.

233PK



7/16-14 x 1 1/2"
 29/32" Head Diameter
 Round Style Head
 Stainless Steel Capped
 Bumper Bolts
 G.M.
 10 Pcs.

231PK



1/2-13 x 1 1/2"
 1 3/32" Head Diameter
 Round Style Head
 Stainless Steel Capped
 Bumper Bolts
 G.M.
 25 Pcs.

9275PK



8-1.25 x 25mm
 19mm Head Diameter
 Pan Style Head
 Stainless Steel Capped
 Bumper Bolts
 G.M. # 14003784
 25 Pcs.

9877PK



1/4-20 x 7/8"
 5/8" O.D. Flange Size
 3/8" Indented Hex Head
 Black Finish
 Truck Mirror Mounting Screws
 G.M. # 14007510
 25 Pcs.

1282PK



1/4-20" Thread Size
 3/16" Grip Range
 Non Sealing Type
 Steel Jack Nuts
 G.M.
 25 Pcs.

9541PK



1/4-20 x 1"
 5/8" O.D. Loose Washer
 Chrome Finish
 Outside Mirror Mounting Bolts
 Use with # 9371
 G.M. # 367291
 25 Pcs.

9371PK



1/4-20" Thread Size
3/16" Grip Range
Raintite Sealer Type
Steel Jack Nuts
G.M. # 367292
25 Pcs.

9561PK



1/4-20 x 1" Screw Size
Mirror Mounting
Screw & Jack Nut Assembly
G.M. # 367292, 367291
10 Pcs.

1589PK



6-1.00 x 26mm
Chrome Finish
Outside Mirror
Mounting Bolts
Use with # 1793
Ford # N801851-S
25 Pcs.

1793PK



6-1.00mm
Roof Rack Mounting
Raintite Sealer Type
Steel Jack Nuts
G.M. # 14007940
10 Pcs.

10035PK



8-32 Screw Size
5/16" Hole Size
7/16" Stem Length
7/16" Flange Diameter
Black Rubber Well Nuts
G.M.
25 Pcs.

9891PK



10-32 Screw Size
3/8" Hole Size
33/64" Stem Length
1/2" Flange Diameter
Black Rubber Well Nuts
G.M.
25 Pcs.

9543PK



1/4-20 x 1" #10 Head
Phillips Oval Head
Stainless Steel
Roof Rack Machine Screws
Use with # 1095
G.M.
25 Pcs.

1095PK



1/4-20" Screw Size
1/2" Hole Size
9/16" Stem Length
5/8" Flange Diameter
Black Rubber Well Nuts
G.M. # 528846
25 Pcs.

9542PK



6-1.00 x 26mm #10 Head
Phillips Oval Head
Stainless Steel
Roof Rack Machine Screws
Use with # 1284
G.M.
25 Pcs.

1284PK



6-1.00mm Screw Size
12.5mm Hole
16mm Stem Length
5/8" Flange Diameter
Black Rubber Well Nuts
G.M. # 20130258
10 Pcs.

101PK



10-24 Screw Size
3/8" Hex Size
Bright Zinc Finish
Machine Screw Nuts
100 Pcs.



**Bright Zinc Finish
Nylon Insert Lock Nuts**

Part Number	Size	Hex Size	Pkg Qty
9759PK	5/16-18 (USS)	1/2"	100
9819PK	5/16-24 (SAE)	1/2"	50
10344PK	3/8-16 (USS)	9/16"	50
9984PK	7/16-14 (USS)	5/8"	25

4040PK



3/8" Shaft Diameter
 .303 Groove Dia.
 .039" Groove Width
 Black Finish
 "E" Type Retaining Rings
 100 Pcs.



**Grade 5
 Bright Zinc Finish
 Hex Cap Screws**

Part Number	Size	Pkg Qty
1330PK	1/4 -20 x 1/2"	100
1331PK	1/4 -20 x 3/4"	100
1332PK	1/4 -20 x 1"	100
1333PK	1/4 -20 x 1 1/4"	100
1334PK	1/4 -20 x 1 1/2"	100
1335PK	1/4 -20 x 2"	100
1336PK	5/16-18 x 3/4"	100
1337PK	5/16-18 x 1"	100
1338PK	5/16-18 x 1 1/4"	100
1339PK	5/16-18 x 1 1/2"	100
1340PK	5/16-18 x 2"	50
1341PK	5/16-18 x 2 1/2"	50
1342PK	3/8 -16 x 1"	50
1343PK	3/8 -16 x 1 1/4"	50
1344PK	3/8 -16 x 1 1/2"	50
1345PK	3/8 -16 x 2"	50
1346PK	3/8 -16 x 2 1/2"	50
1347PK	3/8 -16 x 3"	50
10277PK	3/8 -16 x 3 1/2"	50
1348PK	7/16-14 x 1"	25
1349PK	7/16-14 x 1 1/4"	25
9749PK	7/16-14 x 1 1/2"	25
1351PK	7/16-14 x 2"	25
1352PK	1/2 -13 x 1 1/2"	25
1353PK	1/2 -13 x 2"	25
1354PK	1/2 -13 x 2 1/2"	25
1355PK	1/2 -13 x 3"	25

4125PK



3/8" Bolt Size
 11/16" Outside Diameter
 Internal Tooth
 Bright Zinc Finish
 Lockwashers
 100 Pcs.



**Bright Zinc Finish
 Finished Hex Nuts**

Part Number	Size	Wrench Size	Pkg Qty
1313PK	1/4 -20	7/16"	100
1314PK	5/16-18	1/2"	100
1315PK	3/8 -16	9/16"	100
1316PK	7/16-14	11/16"	100
1317PK	1/2 -13	3/4"	100



**Bright Zinc Finish
USS Flatwashers**

Part Number	Bolt Size	I.D.	O.D.	Pkg Qty
1319PK	1/4"	5/16"	3/4"	100
1320PK	5/16"	3/8"	7/8"	100
1321PK	3/8"	7/16"	1"	100
1322PK	7/16"	1/2"	1 1/4"	100
1323PK	1/2"	9/16"	1 3/8"	100



**Bright Zinc Finish
Fenderwashers**

Part Number	Bolt Size	O.D.	Thickness	Pkg Qty
149PK	1/4"	1"	1/16"	100
148PK	1/4"	1 1/4"	3/64"	100
147PK	1/4"	1 1/2"	3/64"	50
146PK	5/16"	1 1/4"	3/64"	100
145PK	5/16"	1 1/2"	3/64"	50



**Bright Zinc Finish
SAE Flatwashers**

Part Number	Bolt Size	I.D.	O.D.	Pkg Qty
1364PK	1/4"	9/32"	5/8"	100
1365PK	5/16"	11/32"	11/16"	100
1366PK	3/8"	13/32"	13/16"	100
1367PK	7/16"	15/32"	15/16"	100
1368PK	1/2"	17/32"	1 1/16"	100

9958PK

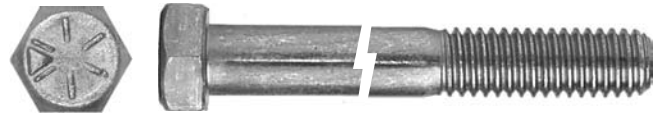

3/8-16" x 4"
Grade 8
Hex Head
Bright Zinc Finish
Cap Screws
25 Pcs.

256PK



3/8-16" (USS) Bolt Size
3/4" O.D. Flange
9/16" Hex Size
Zinc Finish
Serrated Flange Nuts
100 Pcs.



**Bright Zinc Finish
Spring Steel
Standard Lockwashers**

Part Number	Size	Pkg Qty
1325PK	1/4"	100
1326PK	5/16"	100
1327PK	3/8"	100
1328PK	7/16"	100
1329PK	1/2"	50



**180,000 P.S.I.
Tensile Strength
Grade 9
Bright Yellow Zinc Finish
Body & Frame Clamp
Replacement Bolts
Made in the USA**

Part Number	Size	Pkg Qty
9884PK	1/2-13 x 2" (USS)	5
10404PK	1/2-13 x 2 1/2" (USS)	5
9806PK	1/2-13 x 3" (USS)	5
9741PK	5/8-11 x 3" (USS)	5
9742PK	5/8-11 x 3 1/2" (USS)	5
9743PK	5/8-11 x 4" (USS)	5
9744PK	5/8-11 x 4 1/2" (USS)	5

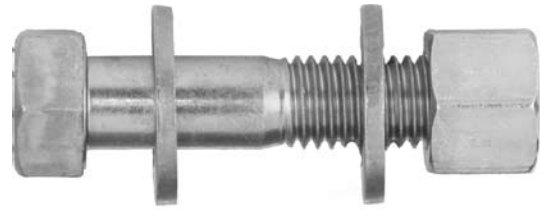

**Grade 9
Bright Yellow Zinc Finish
Body & Frame Clamp
Replacement Bolt Kits
Made in the USA**

Contains: 2 Bolts, 2 Nuts, 4 Flat Washers

Part Number	Size	Pkg Qty
9970	1/2-13 x 2"	1 Kit
9971	1/2-13 x 3"	1 Kit
1539	5/8-11 x 3"	1 Kit
1540	5/8-11 x 3 1/2"	1 Kit
1541	5/8-11 x 4"	1 Kit
1542	5/8-11 x 4 1/2"	1 Kit

Contains: 16 Bolts, 16 Nuts, 16 Flat Washers

Part Number	Size	Pkg Qty
10380	1/2-13 x 2 1/2"	1 Kit
10381	5/8-11 x 3 1/2"	1 Kit



**Grade 9
Bright Yellow Zinc Finish
Body & Frame Clamp
Replacement Special
Tall Nuts
Made in the USA**

Part Number	Size	Pkg Qty
9807PK	1/2-13 (USS)	10
9739PK	5/8-11 (USS)	10



**Grade 9
Bright Yellow Zinc Finish
Body & Frame Clamp
Replacement
Thick Flatwashers
Made in the USA**

Part Number	Size	Pkg Qty
9808PK	1/2 (SAE)	20
9740PK	5/8 (SAE)	20

**Hammerlock Type
Zinc Plated Cotter Pins**

Insert

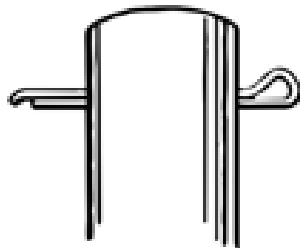

Insert as you would any ordinary cotter pin. Hob-Lok pins have specially tapered parallel shanks for quick insertion.

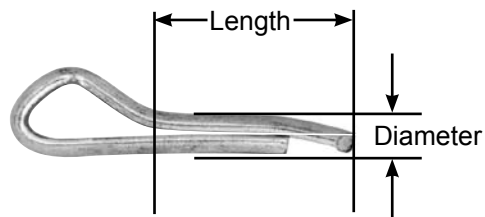

Hit with Hammer



Shanks Spread and Lock Themselves

When hammer hits head of Hob-Lok pin, it forces the shorter shank down over the curved end of the longer shank, thus causing the lower ends of the shanks to spread apart. This simple operation locks the pin securely in place. No twisting or spreading of the shanks is necessary. It is all done automatically!

Twist to Remove

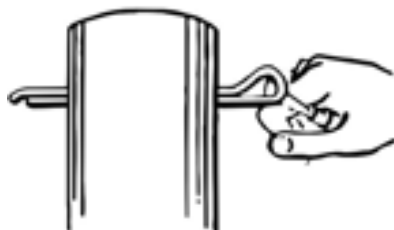

To remove, insert any small tool in eye of Hob-Lok pin. Twist shorter shank to original position and remove.

Part Number	Size	Pkg Qty
4062PK	1/16 x 3/4"	200
4063PK	1/16 x 1"	200
4064PK	1/16 x 1 1/4"	200
4065PK	1/16 x 1 1/2"	200
4067PK	1/16 x 2"	200
4069PK	3/32 x 3/4"	200
4070PK	3/32 x 1"	200
4071PK	3/32 x 1 1/4"	200
4072PK	3/32 x 1 1/2"	200
4074PK	3/32 x 2"	200
4084PK	1/8 x 3/4"	200
4086PK	1/8 x 1"	200
4087PK	1/8 x 1 1/4"	200
4088PK	1/8 x 1 1/2"	200
4089PK	1/8 x 1 3/4"	200
4090PK	1/8 x 2"	200
4091PK	1/8 x 2 1/2"	200
4094PK	5/32 x 1"	100
4095PK	5/32 x 1 1/4"	100
4096PK	5/32 x 1 1/2"	100
4098PK	5/32 x 2"	100
4100PK	5/32 x 2 1/2"	100
4103PK	3/16 x 1"	100
4105PK	3/16 x 1 1/2"	100
4107PK	3/16 x 2"	100
4108PK	3/16 x 2 1/2"	100
4112PK	1/4 x 1"	100
4114PK	1/4 x 1 1/2"	100
4116PK	1/4 x 2"	100

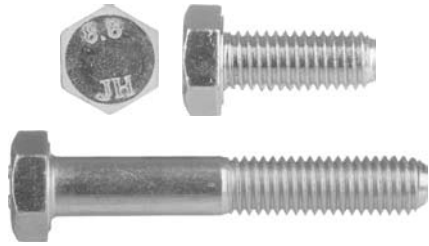

**Bright Zinc Finish
Class 8.8
Hex Head Cap Screws
Din# 933 (Fully Threaded)
Din# 931 (Partially Threaded)**

Part Number	Size	Thread Pitch	Wrench Size	Din Number	Pkg Qty
869PK	4 x 16mm	.70	7mm	933	50
870PK	4 x 20mm	.70	7mm	933	50
871PK	5 x 10mm	.80	8mm	933	50
872PK	5 x 16mm	.80	8mm	933	50
873PK	5 x 20mm	.80	8mm	933	50
874PK	5 x 25mm	.80	8mm	933	50
875PK	5 x 30mm	.80	8mm	933	25
876PK	6 x 10mm	1.00	10mm	933	50
9765PK	6 x 16mm	1.00	10mm	933	25
877PK	6 x 20mm	1.00	10mm	933	25
878PK	6 x 25mm	1.00	10mm	933	25
879PK	6 x 30mm	1.00	10mm	933	25
880PK	6 x 35mm	1.00	10mm	931	25
881PK	6 x 40mm	1.00	10mm	931	25
9766PK	6 x 50mm	1.00	10mm	931	25
884PK	8 x 12mm	1.25	13mm	933	25
885PK	8 x 16mm	1.25	13mm	933	25
886PK	8 x 20mm	1.25	13mm	933	25
887PK	8 x 25mm	1.25	13mm	933	25
888PK	8 x 30mm	1.25	13mm	933	25
889PK	8 x 40mm	1.25	13mm	931	25
890PK	8 x 50mm	1.25	13mm	931	25
891PK	8 x 60mm	1.25	13mm	931	25
892PK	8 x 70mm	1.25	13mm	931	10

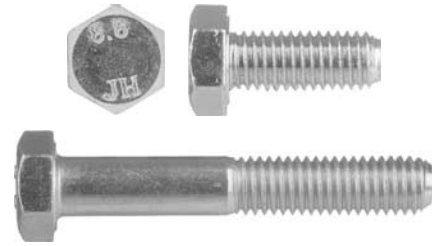

**Bright Zinc Finish
Class 8.8
Hex Head Cap Screws
Din# 933 (Fully Threaded)
Din# 931 (Partially Threaded)**

Part Number	Size	Thread Pitch	Wrench Size	Din Number	Pkg Qty
893PK	10 x 20mm	1.50	17mm	933	25
894PK	10 x 25mm	1.50	17mm	933	25
895PK	10 x 30mm	1.50	17mm	933	25
896PK	10 x 35mm	1.50	17mm	933	15
897PK	10 x 40mm	1.50	17mm	931	15
899PK	10 x 50mm	1.50	17mm	931	15
900PK	10 x 60mm	1.50	17mm	931	10
903PK	12 x 25mm	1.75	19mm	933	10
904PK	12 x 30mm	1.75	19mm	933	10
905PK	12 x 40mm	1.75	19mm	933	10
906PK	12 x 50mm	1.75	19mm	931	10
907PK	12 x 60mm	1.75	19mm	931	10



**Bright Zinc Finish
Class 8
Metric Hex Nuts
Din# 934**

Part Number	Size	Thread Pitch	Wrench Size	Pkg Qty
861PK	4mm	.70	7mm	50
862PK	5mm	.80	8mm	50
863PK	6mm	1.00	10mm	100
865PK	8mm	1.25	13mm	100
866PK	10mm	1.50	17mm	50
867PK	12mm	1.75	19mm	25



**Bright Zinc Finish
Spring Steel
Metric Lockwashers
Din# 127**

Part Number	Bolt Size	I.D.	O.D.	Pkg Qty
1658PK	4mm	4.1mm	7.4mm	50
1659PK	5mm	5.1mm	9.0mm	50
1661PK	6mm	6.1mm	11.5mm	100
1662PK	8mm	8.2mm	14.2mm	100
1663PK	10mm	10.2mm	17.5mm	50
1664PK	12mm	12.2mm	20.3mm	25



**Bright Zinc Finish
Metric Flatwashers
Din# 125**

Part Number	Bolt Size	I.D.	O.D.	Pkg Qty
1651PK	4mm	4.3mm	9mm	50
1652PK	5mm	5.3mm	11mm	50
1654PK	6mm	6.4mm	12mm	100
1655PK	8mm	8.4mm	17mm	100
1656PK	10mm	10.5mm	21mm	100
1657PK	12mm	13mm	24mm	25

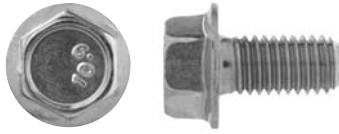

**Bright Zinc Finish
Class 10.9
J.I.S. Small Head
Hex Flange Bolts**

Part Number	Size	Thread Pitch	Wrench Size	Flange O.D.	Pkg Qty
3203PK	6 x 12mm	1.00	10mm	14mm	50
3204PK	6 x 16mm	1.00	10mm	14mm	50
3205PK	6 x 20mm	1.00	10mm	14mm	50
3206PK	6 x 25mm	1.00	10mm	14mm	25
3207PK	6 x 30mm	1.00	10mm	14mm	25
3208PK	6 x 35mm	1.00	10mm	14mm	25
3209PK	6 x 40mm	1.00	10mm	14mm	25
9824PK	6 x 45mm	1.00	10mm	14mm	15
3210PK	8 x 12mm	1.25	12mm	17.5mm	25
3211PK	8 x 16mm	1.25	12mm	17.5mm	15
3212PK	8 x 20mm	1.25	12mm	17.5mm	15
3213PK	8 x 25mm	1.25	12mm	17.5mm	15
3214PK	8 x 30mm	1.25	12mm	17.5mm	15
3215PK	8 x 35mm	1.25	12mm	17.5mm	15
3216PK	8 x 40mm	1.25	12mm	17.5mm	15
3217PK	10 x 16mm	1.25	14mm	21mm	10
3218PK	10 x 20mm	1.25	14mm	21mm	10
3219PK	10 x 25mm	1.25	14mm	21mm	10
3220PK	10 x 30mm	1.25	14mm	21mm	10
3221PK	10 x 35mm	1.25	14mm	21mm	10
3222PK	10 x 40mm	1.25	14mm	21mm	10



**Bright Zinc Finish
Class 10
Metric Spin Lock Nuts
Serrated**

Part Number	Size	Thread Pitch	Wrench Size	Flange O.D.	Pkg Qty
3200PK	6mm	1.00	10mm	14mm	50
3201PK	8mm	1.25	12mm	17mm	50
3202PK	10mm	1.25	14mm	20.5mm	25



***Special
Nuts***

688PK

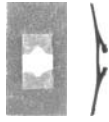

1/8" Stud Size
5/16" x 9/16"
Flat Type
Black Finish
Flat Type Speed Nuts
100 Pcs.

690PK

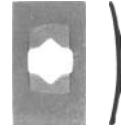

3/16" Stud Size
3/8" x 5/8"
Flat Type
Black Finish
Flat Type Speed Nuts
100 Pcs.

9894PK

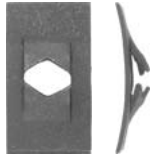

10-24" Screw Size
7/16" x 3/4" Plate Size
Black Phosphate
Flat Type Speed Nuts
100 Pcs.

1684PK



1/8" Stud Size
3/8" Flange O.D.
Zinc Finish
Push On Type
Retainers
100 Pcs.

1685PK



5/32" Stud Size
7/16" Flange O.D.
Zinc Finish
Push On Type
Retainers
100 Pcs.

1686PK



3/16" Stud Size
7/16" Flange O.D.
Zinc Finish
Push On Type
Retainers
100 Pcs.

1687PK



1/4" Stud Size
17/32" Flange O.D.
Zinc Finish
Push On Type
Retainers
100 Pcs.

9852PK



5/32" (#8) Bolt Size
3/8" Flange O.D.
Black Finish
Push On Type
Retainers
100 Pcs.

1273PK



1/4" Bolt Size
1/2" Flange O.D.
Black Finish
Push On Type
Retainers
100 Pcs.

1274PK



5/16" Bolt Size
5/8" Flange O.D.
Zinc Finish
Push On Type
Retainers
100 Pcs.

990PK



7/16" Bolt Size
27/32" Flange O.D.
Black Finish
Push On Type
Retainers
100 Pcs.

989PK



3/8" Bolt Size
25/32" Flange O.D.
Black Finish
Push On Type
Retainers
100 Pcs.

991PK



1/2" Bolt Size
15/16" Flange O.D.
Black Finish
Push On Type
Retainers
100 Pcs.

9850PK



3.2mm Stud Size
9.5mm Flange O.D.
Zinc Finish
Push On Type
Retainers
G.M. # 11502794
100 Pcs.

1691PK



4mm Stud Size
11mm Flange O.D.
Black Finish
Push On Type
Retainers
G.M. # 11501937
100 Pcs.

10937PK

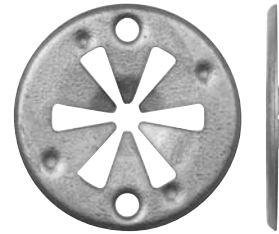

5mm Stud Size
Outside Diameter: 30mm
Dacromet Finish
Push On Type
Retainers
V.W. # N90-796-502
25 Pcs.

1275PK



6 -1.00mm Bolt Size
12.7mm Flange O.D.
Zinc Finish
Push On Type Retainers
Retainers
100 Pcs.

1621PK



6-1.00mm Bolt Size
17mm Flange O.D.
Black Finish
Push On Type
Retainers
Chrysler # 6501178
100 Pcs.

1043PK



8-1.25mm Bolt Size
16mm Flange O.D.
Zinc Finish
Push On Type
Retainers
G.M. # 11502504
100 Pcs.

3010PK

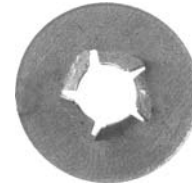

8-1.25mm Bolt Size
24mm Flange O.D.
Dacromet Finish
Push On Type
Bumper Strip
Retainers
G.M. # 10009923
50 Pcs.

1276PK



10-1.50mm Bolt Size
24mm Flange O.D.
Dacromet Finish
Push On Type
Retainers
G.M. # 11501849
50 Pcs.

1044PK



12-1.75mm Bolt Size
21mm Flange O.D.
Black Finish
Push On Type
Retainers
50 Pcs.

9952PK



14-2.00mm Bolt Size
25mm Flange O.D.
Black Finish
Push On Type
Retainers
G.M. # 11504119
50 Pcs.

708PK



1/8" Stud Size
5/32" Hole Size
Black Finish
Barrel Nuts
100 Pcs.

709PK



1/8" Stud Size
3/16" Hole Size
Black Finish
Barrel Nuts
Ford # 375890-S100
100 Pcs.

710PK



1/8" Stud Size
1/4" Hole Size
Black Finish
Barrel Nuts
Ford # 375480-S100
100 Pcs.

9878PK



3/16" Stud Size
7/64" Hole Size
Black Nylon
Barrel Nuts
Renault # 8934-201-767
100 Pcs.

711PK



3/16" Stud Size
7/32" Hole Size
Black Finish
Barrel Nuts
Chrysler # 6000558
100 Pcs.

9941PK



1/4" Stud Size
9/32" Hole Size
Black Finish
Barrel Nuts
Ford # 354341-S
100 Pcs.

265PK



1/8" Stud Size
5/16" Hex Size
17/32" Flange
Zinc Finish
Thread Cutting Nuts
100 Pcs.

264PK



**5/32" Stud Size
11/32" Hex Size
9/16" Flange Size
Zinc Finish
Thread Cutting Nuts
100 Pcs.**

9847PK



**3/16" Stud Size
3/8" Hex Size
1/2" Flange Size
Zinc Finish
Thread Cutting Nuts
200 Pcs.**

263PK



**3/16" Stud Size
3/8" Hex Size
5/8" Flange Size
Zinc Finish
Thread Cutting Nuts
100 Pcs.**

262PK



**1/4" Stud Size
7/16" Hex Size
19/32" Flange Size
Zinc Finish
Thread Cutting Nuts
100 Pcs.**

9226PK



**1/4" Stud Size
7/16" Hex Size
11/16" Flange Size
Zinc Finish
Thread Cutting Nuts
100 Pcs.**

856PK



**5/16" Stud Size
1/2" Hex Size
7/8" Flange Size
Zinc Finish
Thread Cutting Nuts
50 Pcs.**

1040PK



4mm Stud Size
9mm Hex Size
15mm Flange Size
Black Finish
Thread Cutting Nuts
100 Pcs.

1041PK



5mm Stud Size
10mm Hex Size
15mm Flange Size
Black Finish
Thread Cutting Nuts
G.M. # 11508900
50 Pcs.

1042PK



6.3mm Stud Size
11mm Hex Size
18mm Flange Size
Zinc Finish
Thread Cutting Nuts
G.M. # 11501836
50 Pcs.

1622PK



8mm Stud Size
13mm Hex Size
20mm Flange Size
Zinc Finish
Thread Cutting Nuts
G.M. # 11502507
100 Pcs.

259PK



10-24 Screw Size
3/8" Hex Size
31/64" O.D. Serrated Washer
Bright Zinc Finish
Hex Flange Nuts
100 Pcs.

9883PK



1/4-20" Screw Size
7/16" Hex Size
Black Nylon
Hex Flange Nuts
50 Pcs.

5797PK



5-.80mm
8mm Hex Size
11.8mm O.D. Washer
Black Finish
Metric Hex Flange Nuts
G.M. # 11502722
50 Pcs.

5800PK



6-1.00mm
10mm Hex Size
16mm O.D. Serrated Washer
Black Finish
Metric Hex Flange Nuts
100 Pcs.

5805PK



8-1.25mm
13mm Hex Size
19mm O.D. Serrated Washer
Black Finish
Metric Hex Flange Nuts
100 Pcs.

1017PK



10-1.50mm
15mm Hex Size
21mm O.D. Washer
Black Finish
Metric Hex Flange Nuts
G.M. # 11501850
25 Pcs.

1639PK



5-.80mm
10mm Hex Size
15mm O.D. Loose Washer
Black Finish
Metric Hex Nuts
Ford # N621903-S61
50 Pcs.

5910PK



6-1.00mm
10mm Hex Size
16mm O.D. Loose Barbed Washer
Black Finish
Metric Hex Nuts
G.M. # 11505329
25 Pcs.

5915PK



6-1.00mm
10mm Hex Size
19mm O.D. Loose Barbed Washer
Black Finish
Metric Hex Nuts
Chrysler # 6100049
25 Pcs.

10838PK



8-1.25mm
13mm Hex Size
18mm O.D. Loose Barbed Washer
Black Phosphate Finish
Metric Hex Nuts
Chrysler # 6100050
25 Pcs.

5916XPK

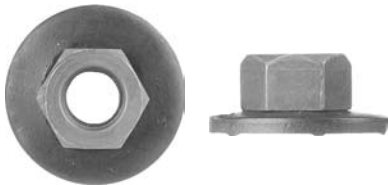

8-1.25mm
13mm Hex Size
24mm O.D. Loose Barbed Washer
Black Finish
Metric Hex Nuts
G.M. # 11503695
25 Pcs.

10053PK



6 Screw Size
Panel Range: .090" - .110"
Center of Hole to Edge: 9/32"
Black Phosphate Finish
Short Type "J" Nuts
25 Pcs.

9866PK



8-32 Screw Size
Panel Range: .110" - .125"
Center of Hole to Edge: 9/32"
Black Finish
"U" Type Speed Nuts
Tinnerman # C7112-832-4
25 Pcs.

9897PK



10-24" Screw Size
Panel Range: .045" - .062"
Center of Hole to Edge: 9/16"
Black Finish
"U" Type Speed Nuts
100 Pcs.

9848PK



1/4"-20 Screw Size
 Panel Range: .064" - .125"
 Center of Hole to Edge: 9/16"
 Black Finish
 "U" Type Speed Nuts
 G.M. # 9431647
 100 Pcs.

9892PK

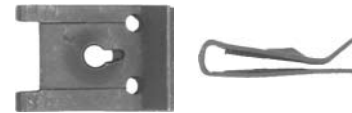

6 Screw Size
 Panel Range: .025" - .125"
 Center of Hole to Edge: 3/8"
 Black Finish
 Wide Range "U" Nuts
 50 Pcs.

1350PK



8 Screw Size
 Panel Range: .020" - .150"
 Center of Hole to Edge: 3/8"
 Black Finish
 Wide Range "U" Nuts
 G.M. # 9424837
 100 Pcs.

1510PK



8 Screw Size
 Panel Range: .120" - .250"
 Center of Hole to Edge: 3/8"
 Black Finish
 Wide Range "U" Nuts
 G.M. # 9433156
 100 Pcs.

5750PK



8 Screw Size
 Panel Range: .025" - .150"
 Center of Hole to Edge: 5/8"
 Black Finish
 Wide Range "U" Nuts
 G.M. # 9433155
 100 Pcs.

5751PK



10 Screw Size
 Panel Range: .025" - .150"
 Center of Hole to Edge: 3/8"
 Black Finish
 Wide Range "U" Nuts
 25 Pcs.

5752PK



10 Screw Size
 Panel Range: .025" - .150"
 Center of Hole to Edge: 5/8"
 Black Finish
 Wide Range "U" Nuts
 50 Pcs.

1192PK

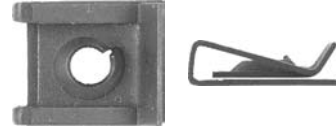

14 Screw Size
 Panel Range: .025" - .150"
 Center of Hole to Edge: 3/8"
 Black Finish
 Wide Range "U" Nuts
 G.M. # 9431532
 25 Pcs.

5753PK



14 Screw Size
 Panel Range: .025" - .150"
 Center of Hole to Edge: 5/8"
 Black Finish
 Wide Range "U" Nuts
 25 Pcs.

1601PK

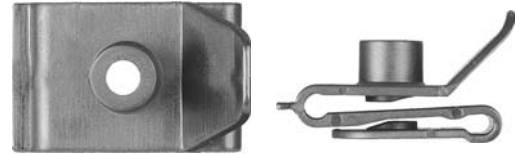

10 Screw Size
 Panel Range: Up to 1mm
 Center of Hole to Edge: 11mm
 Black Nylon
 "U" Type Retainers
 Toyota # 53879-14010-A
 15 Pcs.

10785PK



6mm Screw Size
 16mm Wide 22mm Long
 Center of Hole to Edge: 8mm
 Black Nylon
 Wheel Guard "U" Nuts
 Hyundai #86825-28800
 25 Pcs.

1606PK



14 (1/4") Screw Size
 Panel Range: Up to 1mm
 Center of Hole to Edge: 15mm
 Black Nylon
 Wheel Housing "U" Nuts
 Toyota # 53879-22010
 15 Pcs.

938PK



10-24 Screw Size
 Panel Range: .025" - .125"
 Center of Hole to Edge: 15/32"
 Black Finish
 Extruded "U" Nuts
 G.M. # 152273
 50 Pcs.

938ZPK



10-24 Screw Size
 Panel Range: .025" - .150"
 Center of Hole to Edge: 15/32"
 Bright Zinc Finish
 Extruded "U" Nuts
 50 Pcs.

2969ZYPK



1/4"-20
 Panel Range: .010" - .165"
 Center of Hole to Edge: 17/32"
 Yellow Dichromate Finish
 Extruded "U" Nuts
 25 Pcs.

2969PK



1/4"-20
 Panel Range: .010" - .165"
 Center of Hole to Edge: 17/32"
 Black Finish
 Extruded "U" Nuts
 G.M. # 1494252
 25 Pcs.

10732PK



1/4"-20
 Panel Range: .025" - .150"
 Center of Hole to Edge: 17/32"
 Zinc Organic Finish
 Extruded "U" Nuts
 G.M.
 25 Pcs.

5480PK



1/4"-20
 Panel Range: .010" - .165"
 Center of Hole to Edge: 25/32"
 Black Finish
 Extruded "U" Nuts
 Ford # 45267
 25 Pcs.

1835PK



5/16"-18
 Panel Range: .010" - .165"
 Center of Hole to Edge: 5/8"
 Black Finish
 Extruded "U" Nuts
 G.M. # 1494253
 25 Pcs.

1836PK



5/16"-18
 Panel Range: .010" - .170"
 Center of Hole to Edge: 27/32"
 Black Finish
 Extruded "U" Nuts
 G.M. # 1494258
 25 Pcs.

5412PK



3/8"-16
 Panel Range: .035" - .205"
 Center of Hole to Edge: 3/4"
 Black Finish
 Extruded "U" Nuts
 G.M. # 1494254
 25 Pcs.

5466PK



3/8"-16
 Panel Range: .035" - .220"
 Center of Hole to Edge: 1 1/8"
 Black Finish
 Extruded "U" Nuts
 Ford # 45269
 25 Pcs.

10795PK



#8 (4.2-1.41mm) Screw Size
 Panel Range: .65mm - 3.8mm
 Center of Hole to Edge: 9.5mm
 Zinc Organic Finish
 Extruded "U" Nuts
 GM # 11513599
 25 Pcs.

1012PK



5-.80mm
 Panel Range: .030" - .160"
 Center of Hole to Edge: 5/8"
 Black Phosphate Finish
 Extruded "U" Nuts
 G.M. # 11500657
 50 Pcs.

9949PK



6-1.00mm
 Prevailing Torque
 Center of Hole to Edge: 9/16"
 Extruded "U" Nuts
 GM 4435-M Finish
 25 Pcs.

5596PK



6-1.00mm
 Panel Range: .010" - .165"
 Center of Hole to Edge: 17/32"
 Black Finish
 Extruded "U" Nuts
 G.M. # 11503957
 25 Pcs.

9512PK



6-1.00mm
 Panel Range: .140" - .250"
 Center of Hole to Edge: 17/32"
 Black Phosphate Finish
 Extruded "U" Nuts
 G.M. # 11504047
 25 Pcs.

5650PK



6-1.00mm
 Panel Range: .010" - .165"
 Center of Hole to Edge: 25/32"
 Black Finish
 Extruded "U" Nuts
 G.M. # 11503715
 25 Pcs.

5559PK



6.3-1.00mm
 Panel Range: .010" - .165"
 Center of Hole to Edge: 17/32"
 Black Finish
 Extruded "U" Nuts
 G.M. # 11500658
 25 Pcs.

5560PK



8-1.25mm
 Panel Range: .010" - .165"
 Center of Hole to Edge: 9/16"
 Black Finish
 Extruded "U" Nuts
 G.M. # 11500660
 25 Pcs.

5557PK



8-1.25mm
 Panel Range: .010" - .175"
 Center of Hole to Edge: 13/16"
 Black Finish
 Extruded "U" Nuts
 G.M. # 11500661
 25 Pcs.

5558PK



10-1.50mm
 Panel Range: .035" - .232"
 Center of Hole to Edge: 3/4"
 Black Finish
 Extruded "U" Nuts
 G.M. # 11500662
 25 Pcs.

10090PK

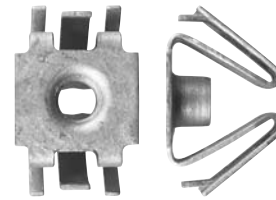

6-1.00mm Screw Size
 Zinc Organic
 Door Trim Panel
 Retainer Nuts
 G.M. # 11517769
 10 Pcs.

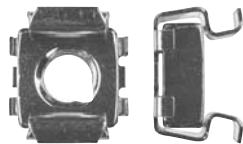

**Zinc & Black Finish
 Square Type Cage Nuts
 Standard**



Part Number	Size	Panel Range	Mounting Hole	Finish	Pkg Qty
11005PK	10-24" Screw Size	.025 - .063	3/8"	Zinc	50 Pcs.
11006PK	10-24" Screw Size	.064 - .105	3/8"	Zinc	50 Pcs.
11007PK	10-32" Screw Size	.025 - .063	3/8"	Zinc	50 Pcs.
11008PK	10-32" Screw Size	.064 - .105	3/8"	Zinc	50 Pcs.
11009PK	1/4-20" Screw Size	.025 - .063	3/8"	Zinc	50 Pcs.
11010PK	1/4-20" Screw Size	.064 - .105	3/8"	Zinc	50 Pcs.
11011PK	5/16-18" Screw Size	.093 - .126	1/2"	Zinc	50 Pcs.
11012PK	3/8-16" Screw Size	.093 - .126	1/2"	Zinc	50 Pcs.
11016PK	3/8-24" Screw Size	.057 - .032	1/2"	Black	50 Pcs.

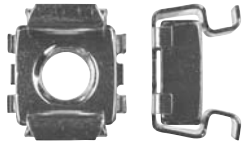

**Zinc Finish
Square Type Cage Nuts
Metric**

Part Number	Size	Panel Range	Mounting Hole	Finish	Pkg Qty
11013PK	5-.80mm Screw Size	1.626 - 2.667	3/8"	Zinc	50 Pcs.
11014PK	6-1.00mm Screw Size	.635 - 1.60	3/8"	Zinc	50 Pcs.
11015PK	6-1.00mm Screw Size	1.626 - 2.667	3/8"	Zinc	50 Pcs.

2157PK



#4 Screws Size
Hole Size: 7mm
Stem Length: 17mm
Natural Nylon
Center Pillar Screw Grommets
Honda # 91620-SR2-003
10 Pcs.

9085PK



#6 (3.5mm) Screw Size
Panel Range: .060" - .150"
Hole Size: 15/64" Stem: 3/64"
White Nylon
Side Marker Light Nuts
G.M. # 1254815
50 Pcs.

1297PK



#6 (3.5mm) Screw Size
Hole Size: 9/32"
Stem Length: 5/16"
Natural Nylon
Headlight Bezel Nuts
G.M. # 1370853
50 Pcs.

9111PK



#6 (3.5mm) Screw Size
Hole Size: 6.5mm x 7.5mm
Stem Length: 8.5mm
Natural Nylon
Headlight Bezel Nuts
G.M. # 380382
50 Pcs.

9112PK



#6 (3.5mm) Screw Size
Hole Size: 7mm x 7.5mm
Stem Length: 8mm
Natural Nylon
Screw Grommets
Toyota # 90189-04011
25 Pcs.

10808PK



#6 (3.5mm) Screw Size
Hole Size: 6mm x 14mm
Stem Length: 7mm
White Nylon
Rocker Trim Screw Grommets
Lexus # 90189-04059
25 Pcs.

1636PK



#6 (3.5mm) Screw Size
Hole Size: 7mm
Stem Length: 15mm
Natural Nylon
Screw Grommets
Honda # 90672-671-8110M1
25 Pcs.

2156PK



#6 (3.5mm) Screw Size
Hole Size: 7mm
Stem Length: 6.5mm
Natural Nylon With Sealer
Body Side Screw Grommets
Nissan # 01281-00501
15 Pcs.

9591PK



#6 (3.5mm) Screw Size
Hole Size: 7mm
Stem Length: 10mm
Natural Nylon With Sealer
Screw Grommets
Honda # 90662-693-0030
25 Pcs.

10618PK



8mm x 9mm Hole Size
Stem Length: 13mm
White Nylon With Sealer
Cowl Vent Grommets
Use with # 10678
Nissan # 80874-0P00
15 Pcs.

10678PK



Stem Diameter: 4.1mm
 Stem Length: 15mm
 Black Nylon
 Cowl Screen Pin Retainers
 Use with # 10618
 Nissan # 66820-88E00
 25 Pcs.

10619PK

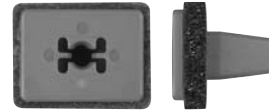

#6 (3.5mm) Screw Size
 Hole Size: 12mm x 16mm
 Stem Length: 12mm
 Blue Nylon With Sealer
 Windshield Mldg. Grommets
 Nissan # 76848-50Y00
 10 Pcs.

1407PK



#6 (3.5mm) Screw Size
 Hole Size: 7.1mm x 20.3mm
 Stem Length: 16.5mm
 Black Nylon
 High Torque Screw Grommets
 G.M. # 10032838
 25 Pcs.

9873PK



#6 (3.5mm) Screw Size
 Hole Size: 7mm x 7.5mm
 Stem Length: 8mm
 Headlight Door To
 Radiator Grille Anchor Nuts
 G.M. # 1355003
 50 Pcs.

1202PK

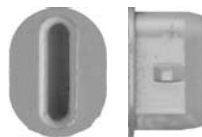

#6 (3.5mm) Screw Size
 Hole Size: 7mm x 15mm
 Stem Length: 8.5mm
 Natural Nylon
 Grille Attachment Grommets
 G.M. # 14032291
 50 Pcs.

637PK

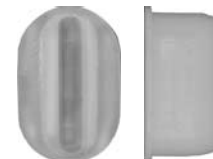

#6 (3.5mm) Screw Size
 Hole Size: 7mm x 18.5mm
 Natural Nylon
 Valance Panel to Rear
 Bumper Bar Grommets
 G.M. # 1377030
 100 Pcs.

1227PK



#6 (3.5mm) Screw Size
 Hole Size: 6.5mm x 9mm
 Stem Length: 8.5mm
 Black Nylon
 Front Fender Grille Nuts
 Ford # N-800503S
 50 Pcs.

1577PK

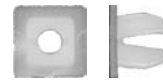

#8 (4.2mm) Screw Size
 Hole Size: 6mm
 Stem Length: 6.5mm
 Natural Nylon
 Side Marker Light Nuts
 Nissan # 96706-B0700
 50 Pcs.

10556PK

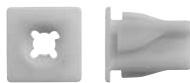

#8 (4.2mm) Screw Size
 Hole Size: 6.7mm
 Stem Length: 11mm
 Natural Nylon
 Door Reveal Screw Grommets
 G.M. # 25647358
 25 Pcs.

9113PK



#8 (4.2mm) Screw Size
 Hole Size: 7mm
 Stem Length: 9mm
 Natural Nylon
 Radiator Grille Nuts
 Chrysler # 6000943
 100 Pcs.

2940PK



#8 (4.2mm) Screw Size
 Hole Size: 5/16"
 Stem Length: 17/64"
 Natural Nylon
 Headlamp Bezel Nuts
 G.M. # 14013246
 50 Pcs.

1997PK



#8 (4.2mm) Screw Size
 Hole Size: 7.5mm
 Stem Length: 8mm
 Black Nylon
 Tail Light Grommets
 G.M. # 3997391
 25 Pcs.

1842PK



#8 (4.2mm) Screw Size
 Hole Size: 1/4"
 Stem Length: 13/32"
 Natural Nylon
 Grille Screw Nuts
 Ford # 379830-S
 50 Pcs.

10497PK



#8 (4.2mm) Screw Size
 Hole Size: 5.5mm
 Stem Length: 12mm
 Natural Nylon
 Rear Bumper Screw Grommets
 Ford # W711412-S300
 50 Pcs.

1574PK



#8 (4.2mm) Screw Size
 Hole Size: 5/16"
 Stem Length: 9/32"
 Natural Nylon
 Grille Screw Nuts
 G.M. # 3919773
 100 Pcs.

2980PK



#8 (4.2mm) Screw Size
 Hole Size: 5/16"
 Stem Length: 9/32"
 Natural Nylon
 Grille Screw Nuts
 G.M. # 3893980
 50 Pcs.

9050PK



#8 (4.2mm) Screw Size
 Hole Size: 11/32"
 Stem Length: 17/64"
 Natural Nylon
 Grille Screw Nuts
 50 Pcs.

10553PK



#8 (4.2mm) Screw Size
 Hole Size: 1/2" x 15/32"
 Black Nylon
 Door Panel & Fender Shield
 Screw Grommets
 Chrysler # 6035821
 25 Pcs.

10783PK

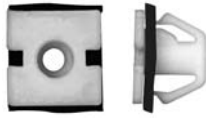

#8 (4.2mm) Screw Size
Hole Size: 8mm x 12mm
Head: 14mm Stem: 10mm
White Nylon With Sealer
Body Side Moulding Clips
Hyundai # 87756-3D000
15 Pcs.

10548PK

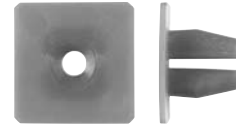

#8 (4.2mm) Screw Size
Hole Size: 9mm
Stem Length: 10mm
Natural Nylon
Door Trim Panel Nuts
Chrysler # 6035401
25 Pcs.

10668PK

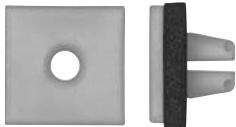

#8 (4.2mm) Screw Size
Hole Size: 9mm
Stem Length: 3/8"
Tan Nylon With Sealer
Tail Light Nuts
Chrysler # 6505703AA
15 Pcs.

10922PK



#8 (4.2mm) Screw Size
Hole Size: 9.5mm x 12mm
Stem Length: 10mm
Maroon Nylon
Scuff Plate Screw Grommets
V.W. # 1J0-853-120
15 Pcs.

10636PK



#8 (4.2mm) Screw Size
Hole: 9mm Stem: 10mm
Natural Nylon
Bumper, Fender & Light
Screw Grommets
Nissan # 01281-00831
25 Pcs.

1572PK

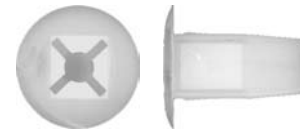

#8 (4.2mm) Screw Size
Hole Size: 8mm
Stem Length: 17mm
Natural Nylon
Screw Grommets
Honda # 90661-SC7-0030
25 Pcs.

10938PK

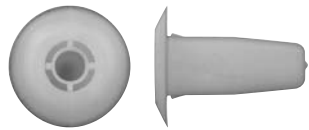

#8 (4.2mm) Screw Size
Hole Size: 8.5mm
Stem Length: 18.5mm
Natural Nylon
Screw Grommets
V.W. # 321-813-998A
25 Pcs.

10926PK

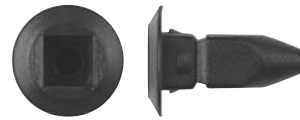

#8 (4.2mm) Screw Size
Hole Size: 9mm Stem: 20mm
Black Nylon
Bumper & Fender
Screw Grommets
V.W. # N908-214-01
15 Pcs.

10524PK

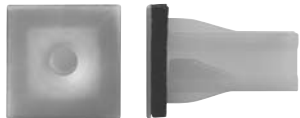

#8 (4.2mm) Screw Size
Hole Size: 8.5mm
Stem Length: 20mm
Natural Nylon With Sealer
Door Trim Panel Grommets
Chrysler # 6507009-AA
25 Pcs.

10552PK

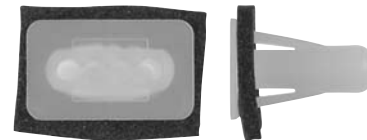

#8 (4.2mm) Screw Size
Hole Size: 6mm x 16.5mm
Natural Nylon With Sealer
Back Glass Mldg. & Interior Trim
Screw Grommets
Ford # W705590-S300
15 Pcs.

10779PK



#8 (4.2mm) Screw Size
Head Dia.: 17mm x 25mm
Stem Length: 14mm
White Nylon With Sealer
Fender & Rocker Moulding Clips
Hyundai # 87758-37000
25 Pcs.

10772PK



8mm x 10mm Hole Size
Head Dia.: 17mm x 25mm
Stem Length: 16mm
Yellow Nylon With Sealer
Exterior Trim Grommets
Hyundia # 87759-27000
25 Pcs.

10498PK



8.5mm x 15.5mm Hole Size
 Head Size: 13mm x 20mm
 Stem Length: 17.5mm
 Blue Nylon With Sealer
 Headlight Grommets
 G.M. # 11561382
 10 Pcs.

10554PK



9mm x 16mm Hole Size
 Head Size: 13mm x 20mm
 Stem Length: 17mm
 Black Nylon With Sealer
 Rear Light Housing Grommets
 G.M. # 15284612
 15 Pcs.

1614PK



#10 (4.8mm) Screw Size
 Hole Size: 8.5mm
 Stem Length: 8mm
 Natural Nylon
 Screw Grommets
 Toyota # 90189-06010
 25 Pcs.

1610PK



#10 (4.8mm) Screw Size
 Hole Size: 9mm
 Stem Length: 7mm
 Black Nylon
 Screw Grommets
 Toyota # 90189-06018
 25 Pcs.

10794PK



5.5mm Screw Size
 Hole Size: 9mm x 11mm
 Stem Length: 10mm
 White Nylon
 Front Bumper Nuts
 Toyota # 90189-06193
 25 Pcs.

10777PK



#10 (4.8mm) Screw Size
 Hole Size: 8.5mm
 Stem Length: 10mm
 Black Nylon
 Fender Apron Nuts
 Hyundai # 86848-22000
 25 Pcs.

10659PK

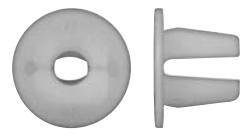

#10 (4.8mm) Screw Size
Hole Size: 9mm
Stem Length: 10mm
Natural Nylon
Screw Grommets
Toyota # 90189-06006
25 Pcs.

1296PK



#10 (4.8mm) Screw Size
Hole Size: 8mm x 8.5mm
Stem Length: 8mm
Natural Nylon
Screw Grommets
Honda # 90662-671-0030
25 Pcs.

1560PK

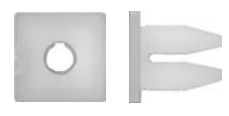

#10 (4.8mm) Screw Size
Hole Size: 8mm x 9mm
Stem Length: 11mm
Natural Nylon
Headlamp Bezel & Grille Nuts
Toyota # 90189-05013
50 Pcs.

10796PK



#10 (4.8mm) Screw Size
Hole: 9mm Stem: 11mm
White Nylon
Front & Rear Bumper
Fender Nuts
Hyundia # 14913-05010
25 Pcs.

10620PK

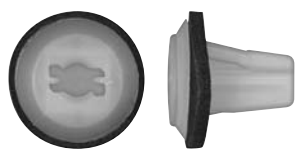

#10 (4.8mm) Screw Size
Hole: 8.5mm Stem: 13mm
Natural Nylon With Sealer
Body Side Floor & Trunk
Moulding Screw Grommets
Nissan # 01281-00601
15 Pcs.

1576PK

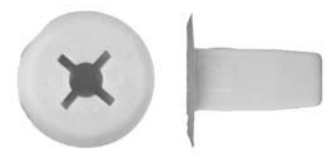

#10 Screw Size
Hole Size: 8.5mm
Stem Length: 17mm
Natural Nylon
Screw Grommets
Toyota # 90189-06001
25 Pcs.

10549PK

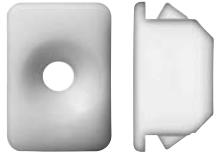

#10 (4.8mm) Screw Size
 Head Size: 14mm x 20mm
 Stem Length: 9.5mm
 White Nylon
 Cowl Vent Grommets
 Chrysler # 4860375-AB
 50 Pcs.

10942PK

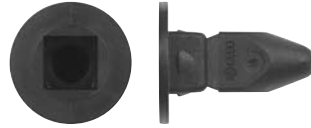

#10 (4.8mm) Screw Size
 Hole Size: 8mm
 Stem Length: 20mm
 Black Nylon
 Door Panel Screw Grommets
 V.W. # 357-827-998
 15 Pcs

10426PK

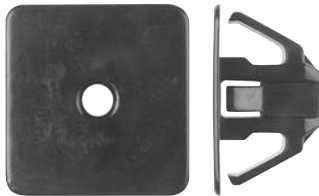

#10 (4.8mm) Screw Size
 Hole: 9.5mm x 23mm Stem: 14mm
 Black Nylon
 Headlight To Grille
 Spacer Bracket Grommets
 Honda # 91635-SM4-003
 10 Pcs.

9912PK

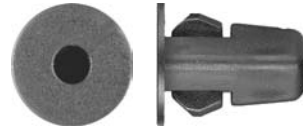

#12 (5.5mm) Screw Size
 Hole: 9mm Stem: 19mm
 Black Nylon
 Front & Rear Wheel
 Fender Liner Screw Grommets
 Toyota # 90189-06028
 15 Pcs.

9913PK

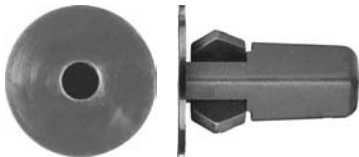

#12 (5.5mm) Screw Size
 Hole: 8mm Stem: 22mm
 Black Nylon
 Front & Rear Wheel
 Fender Liner Screw Grommets
 Toyota # 90189-06157
 15 Pcs.

10551PK

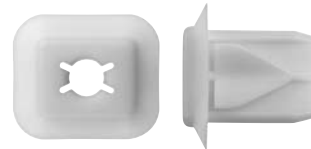

#12 (5.5mm) Screw Size
 Hole Size: 9mm x 12.5mm
 Stem Length: 14mm
 Natural Nylon
 Door Handle Screw Grommets
 G.M. # 11517873
 15 Pcs.

10775PK



#12 (5.5mm) Screw Size
Hole Size: 9mm
Head: 13mm Stem: 8.5mm
White Nylon
Rocker Moulding Clips
Hyundia # 87756-35000
25 Pcs.

10771PK



6mm Screw Size
Hole Size: 8.5mm
Stem Length: 8mm
Black Nylon
Headlight Component Nuts
Ford # W712160-S300
15 Pcs.

10715PK

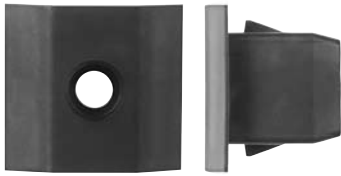

6mm Screw Size
Hole Size: 15mm
Stem Length: 16mm
Black Nylon
Headlight Component Nuts
Ford # W712160-S300
15 Pcs.

10525PK

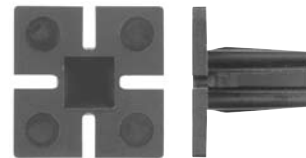

#14 (6.3mm) Screw Size
Hole Size: 8mm
Stem Length: 14mm
Black Nylon
License Plate Grommets
G.M. # 22546934
50 Pcs.

9872PK



#14 (6.3mm) Screw Size
Hole Size: 8.5mm
Stem Length: 8mm
Natural Nylon
License Plate Nuts
G.M. # 380370
50 Pcs.

9101PK



#14 (6.3mm) Screw Size
Hole Size: 8.5 x 10.5mm
Stem Length: 8mm
Natural Nylon
Screw Grommets
Honda # 90656-671-6310M1
50 Pcs.

3

10461PK



#14 (6.3mm) Screw Size
Hole Size: 9.5mm x 10mm
Stem Length: 8mm
Black Nylon With Sealer
License Plate Nuts
Ford # N811478-S100
15 Pcs.

9494PK

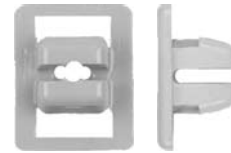

#14 (6.3mm) Screw Size
Hole Size: 3/8"
Stem Length: 5/16"
Natural Nylon
License Plate Nuts
Ford # 380707-S
50 Pcs.

1228PK

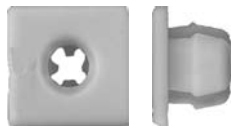

#14 (6.3mm) Screw Size
Hole Size: 13/32"
Stem Length: 5/16"
White Plastic
License Plate Nuts
G.M. # 4755299
50 Pcs.

1605PK

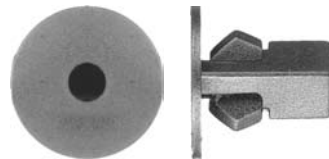

#14 (6.3mm) Screw Size
Hole Size: 8mm
Head: 20mm Stem: 17mm
Black Nylon
Screw Grommets
Toyota # 90189-06013
25 Pcs.

10745PK



5.5mm - 6mm Screw Size
Head Dia.: 17mm x 30mm
Stem Length: 9mm
Black Nylon
Front Bumper Screw Grommets
Toyota # 52535-50060
5 Pcs.

10918PK



7mm Hole Size
Stem Length: 11mm
Black Nylon
Inter Fender Nuts
V.W. # 811-807-577C
25 Pcs.

10617PK

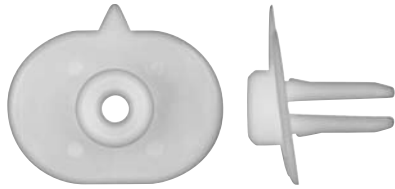

7.5mm x 12mm Hole Size
 Stem Length: 14mm
 Natural Nylon
 Bumper Grommets
 Nissan # 71144-SR3-A00
 25 Pcs.

10943PK

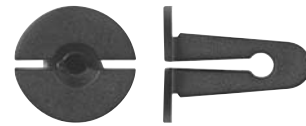

8mm Hole Size
 Stem Length: 18mm
 Black Nylon
 Interior Frame Nuts
 V.W. # 4A0-857-610
 25 Pcs.

9355PK



10mm Hole Size
 Stem Length: 9mm
 Black Nylon
 Grille & Side Marker Light
 Grommets
 Ford # N807994-S
 50 Pcs.

10781PK



10mm Hole Size
 Head Size: 15mm
 Stem Length: 8mm
 Natural Nylon
 Headlight Assembly Grommets
 Kia # 92351-37000
 25 Pcs.

10526PK



11mm Hole Size
 Head Size: 15mm
 Stem Length: 17mm
 Black Nylon
 Tail Light Grommets
 G.M. # 11561655
 5 Pcs.

9712PK



11mm Hole Size
 Head Size: 13mm
 Stem Length: 9mm
 White Nylon
 Park & Turn Signal Grommets
 Ford # N811169-S
 50 Pcs.

9418PK



11.5mm x 15.5mm Hole Size
 Width: 22mm Length: 26mm
 Black Nylon
 Grille Grommet Retainers
 Nissan # 62380-U7400
 10 Pcs.

10550PK

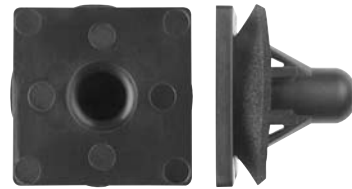

15mm Hole Size
 Head Size: 24mm
 Black Nylon With Sealer
 Rear Light Housing
 Screw Grommets
 G.M. # 15745990
 15 Pcs.

10541PK



Receives 10mm Ball Stud
 Hole Size: 14mm x 26mm
 Black Nylon
 Tail Light Grommets
 Chrysler # 55156879-AB
 25 Pcs.

10971PK



Overall Height: 17mm
 Overall Length: 30mm
 Black Nylon
 Bumper Filler Clips
 Toyota # 53935-35020
 10 Pcs.

9221PK



13/16" O.D.
 Polished Stainless Steel
 With Felt Insert
 Door Lock Rod Ferrule
 G.M. # 330485
 25 Pcs.

10244PK



1/4-20 Screw Size
 Zinc Finish
 Air Cleaner Hold Down
 Wing Nuts
 Ford # 358871-S8B
 10 Pcs.

10245PK

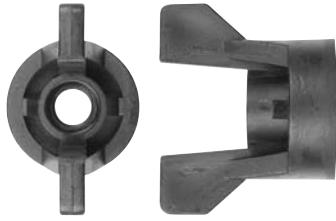

1/4-20 Screw Size
Black Nylon
Air Cleaner Hold Down
Wing Nuts
Chrysler # 5240734
10 Pcs.

10242PK

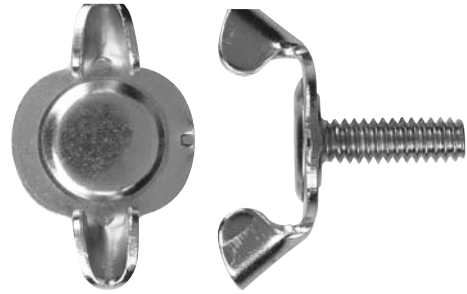

1/4-20 x 1" Screw Size
Zinc Finish
Air Cleaner Hold Down
Wing Nuts
Ford # 383132-S9
10 Pcs.

10243PK

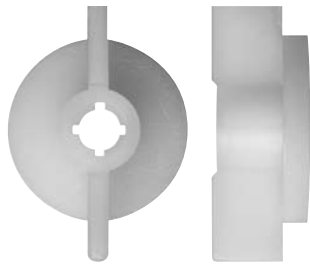

For 1/4" or 6mm Screw Size
Natural Nylon
Air Cleaner Hold Down
Wing Nuts
Ford # 386285
10 Pcs.

10240PK



6-1.00mm Screw Size
Yellow Zinc Finish
Air Cleaner Hold Down
Wing Nuts
G.M. # 14001197
10 Pcs.

10241PK



8-1.25mm Screw Size
Zinc Finish
Air Cleaner Hold Down
Wing Nuts
G.M. # 11501818
10 Pcs.

9709PK



5/16-18 Thread Size
Plain Finish
Slab Weld Nuts
25 Pcs.

10210PK



5-.80mm Thread Size
Grip Range: 3.3mm - 5mm
Flange Size: 10mm
Hex Size: 7mm (9/32")
Hex Type Nut Inserts
G.M. # 11501818
10 Pcs.

10211PK



6-1.00mm Thread Size
Grip Range: 4.2mm - 7mm
Flange Size: 13mm
Hex Size: 9.5mm (3/8")
Hex Type Nut Inserts
G.M. # 10281487
15 Pcs.

3

Shield Retainers



JL-24PK



7/64" (2.5mm) Hole Size
Panel Range: .069" - .250"
Head: 7/32" Stem: 25/64"
Black Nylon
Shield Retainers
G.M. # 20729523
100 Pcs.

9863PK



1/8" (3.2mm) Hole Size
Head Diameter: 3/8"
Stem Length: 13/32"
Black Nylon
Weatherstrip Retainers
G.M. # 8731909
100 Pcs.

5602PK



5/32" (4mm) Hole Size
Panel Range: .030" - .275"
Head: 23/64" Stem: 7/16"
Black Nylon
Shield Retainers
G.M. # 10063599
100 Pcs.

5605PK



3/16" (4.5mm) Hole Size
Panel Range: .080" - .200"
Head: 7/16" Stem: 21/64"
Black Nylon
Weatherstrip Retainers
G.M. # 10169777
25 Pcs.

JL-32PK



3/16" (4.5mm) Hole Size
Panel Range: .125" - .310"
Head: 3/8" Stem: 17/32"
Black Nylon
Weatherstrip Retainers
G.M. # 2964547
25 Pcs.

9178PK

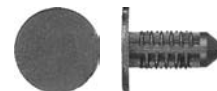

3/16" (4.5mm) Hole Size
Head Diameter: 7/16"
Stem Length: 1/2"
Black Nylon
Facia Shield Retainers
Ford # N803170-S
25 Pcs.

8172PK



3/16" (4.5mm) Hole Size
 Panel Range: .060" - .390"
 Head: 7/16" Stem: 21/32"
 Black Nylon
 Dash Panel Retainers
 G.M. # 25016383
 50 pcs.

10652PK



3/16" (4.8mm) Hole Size
 Head Diameter: 9.4mm
 Stem Length: 16mm
 Black Nylon
 Cowl & Dash Panel Retainers
 Chrysler # 3759944
 50 Pcs.

9857PK



3/16" (5mm) Hole Size
 Panel Range: .100" - .390"
 Head: 13mm Stem: 16mm
 Black Nylon
 Shield Retainers
 Honda # 90666-SA0-0030
 25 Pcs.

9528PK

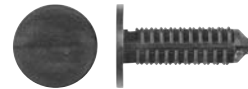

3/16" (5mm) Hole Size
 Head Diameter: 11mm
 Stem Length: 17.8mm
 Black Nylon
 Rear Bumper Fascia Retainers
 G.M. # 1644290
 25 Pcs.

2034PK



3/16" (5mm) Hole Size
 Head Diameter: 20mm
 Stem Length: 15mm
 Black Nylon
 Trim Panel Retainers
 Honda # 90667-SA7-0030
 25 Pcs.

1583PK

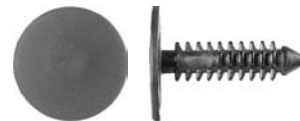

3/16" (5mm) Hole Size
 Head: 19/32" Stem: 3/4"
 Black Nylon
 Screen Shroud Vent
 Grille To Panel Retainers
 G.M. # 20514862
 50 Pcs.

JL-23PK



13/64" (5.3mm) Hole Size
Panel Range: .030" - .285"
Head: 10mm Stem: 11.5mm
Black Nylon
Weatherstrip Retainers
G.M. # 20699808
50 Pcs.

5609PK

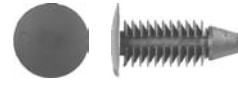

13/64" (5.3mm) Hole Size
Panel Range: .030" - .365"
Head: 19/32" Stem: 5/8"
Black Nylon
Weatherstrip Retainers
Chrysler # 4658673
50 Pcs.

JL-26PK

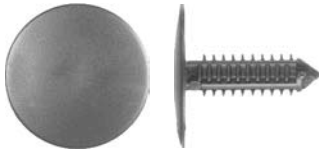

13/64" (5.3mm) Hole Size
Panel Range: .065" - .515"
Head: 3/4" Stem: 11/16"
Blue Nylon
Shield Retainers
Ford # N8010994S
50 Pcs.

10934PK



13/64" (5.5mm) Hole Size
Head Diameter: 14mm
Stem Length: 16mm
Black Nylon
Shield Retainers
V.W. # 823-863-203
50 Pcs.

5610PK



7/32" (5.5mm) Hole Size
Panel Range: .060" - .565"
Head: 21/32" Stem: 3/4"
Black Nylon
Shield Retainers
Chrysler # 6501948
50 Pcs.

5614PK

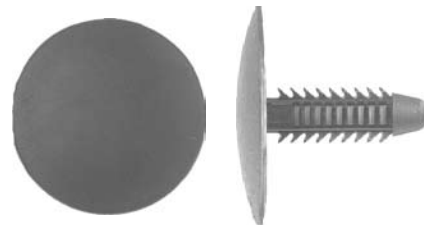

7/32" (5.5mm) Hole Size
Panel Range: .080" - .545"
Head: 1" Stem: 25/32"
Black Nylon
Shield Retainers
Ford # N808370-S
50 Pcs.

10676PK

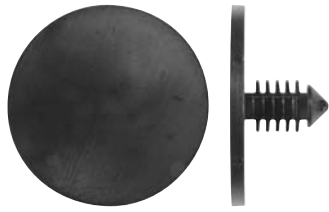

15/64" (6mm) Hole Size
 Head Diameter: 26.6mm
 Stem Length: 11mm
 Black Nylon
 Headliner Retainers
 Chrysler # 04696963
 25 Pcs.

5618PK



15/64" (6mm) Hole Size
 Panel Range: .035" - .285"
 Head: 15/32" Stem: 1/2"
 Black Nylon
 Shield Retainers
 G.M. # 20709017
 50 Pcs.

9446NPK



15/64" (6mm) Hole Size
 Head Diameter: 1/2"
 Stem Length: 15/16"
 Natural Nylon
 Shield Retainers
 25 Pcs.

10568PK

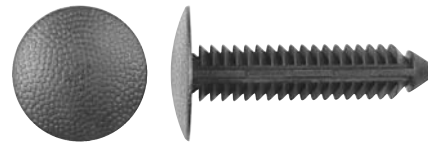

15/64" (6mm) Hole Size
 Head Diameter: 18mm
 Stem Length: 33mm
 Black Nylon
 Wheel Well Shield Retainers
 Ford # W709002
 25 Pcs.

9414PK

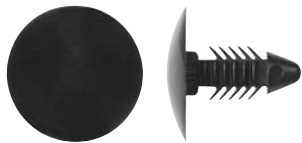

1/4" (6.3mm) Hole Size
 Panel Range: 2.25mm - 4.75mm
 Head: 18mm Stem: 15.2mm
 Black Nylon
 Front Fender Retainers
 Chrysler # 6034608
 50 Pcs.

10391PK

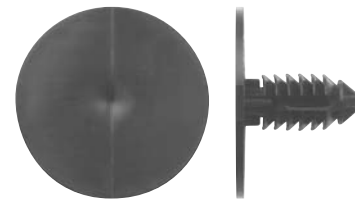

1/4" (6.3mm) Hole Size
 Head Diameter: 25.4mm
 Stem Length: 16mm
 Black Nylon
 Hood Insulation Retainers
 Chrysler # 6504135
 50 Pcs.

4

10064PK

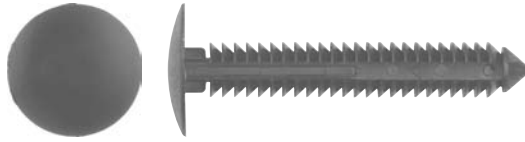

1/4" (6.3mm) Hole Size
 Head Diameter: 18mm
 Stem Length: 45mm
 Black Nylon
 Mud Flap Retainers
 Ford # W707889-S300
 25 Pcs.

1410PK

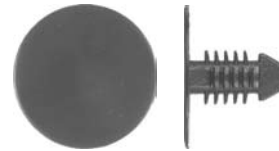

1/4" (6.4mm) Hole Size
 Head Diameter: 3/4"
 Stem Length: 1/2"
 Black Nylon
 Mud Shield Retainers
 G.M. # 20032850
 100 Pcs.

9500PK



1/4" (6.4mm) Hole Size
 Panel Range: .070 - .450"
 Head: 1/2" Stem: 11/16"
 Black Nylon
 Window Moulding Retainers
 AMC # 7703-077-066
 25 Pcs.

1761PK



1/4" (6.4mm) Hole Size
 Panel Range: .115" - .400"
 Head: 11/16" Stem: 21/32"
 Gray Nylon
 Shield Retainers
 G.M. # 6270163
 50 Pcs.

5429PK



1/4" (6.4mm) Hole Size
 Panel Range: .115" - .400"
 Head: 11/16" Stem: 21/32"
 Black Nylon
 Shield Retainers
 G.M. # 332364
 100 Pcs.

5506PK



1/4" (6.4mm) Hole Size
 Panel Range: .110" - .460"
 Head: 1/2" Stem: 23/32"
 Black Nylon
 Trim Panel Retainers
 G.M. # 411700
 50 Pcs.

5625PK



1/4" (6.4mm) Hole Size
Panel Range: .095" - .540"
Head: 23/32" Stem: 13/16"
Black Nylon
Shield Retainers
G.M. # 1605396
100 Pcs.

5625WPK

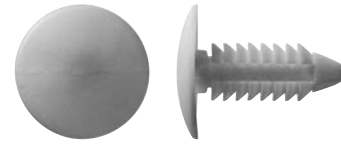

1/4" (6.4mm) Hole Size
Panel Range: .095" - .540"
Head: 23/32" Stem: 13/16"
Appliance White Nylon
Shield Retainers
25 Pcs.

5625CWPK

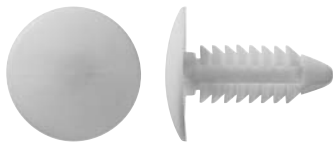

1/4" (6.4mm) Hole Size
Panel Range: .095" - .540"
Head: 23/32" Stem: 13/16"
Creamy White Nylon
Shield Retainers
25 Pcs.

5625GYPK

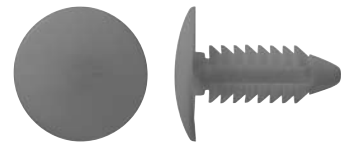

1/4" (6.4mm) Hole Size
Panel Range: .095" - .540"
Head: 23/32" Stem: 13/16"
Grey Nylon
Shield Retainers
25 Pcs.

5625CPK

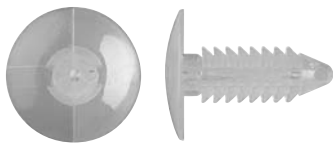

1/4" (6.4mm) Hole Size
Panel Range: .095" - .540"
Head: 23/32" Stem: 13/16"
Clear Nylon
Shield Retainers
25 Pcs.

5625NPK

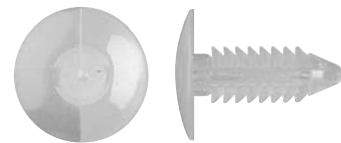

1/4" (6.4mm) Hole Size
Panel Range: .095" - .540"
Head: 23/32" Stem: 13/16"
Natural Nylon
Shield Retainers
25 Pcs.

5632PK



1/4" (6.4mm) Hole Size
Panel Range: .070" - .590"
Head: 25.5mm Stem: 20mm
Black Nylon
Fascia Panel Retainers
Chrysler # 6501067
50 Pcs.

9446PK



1/4" (6.4mm) Hole Size
Head: 1/2" Stem: 15/16"
Black Nylon
Engine Mount Heat
Retainers
Ford # N804448
25 Pcs.

9130PK



1/4" (6.4mm) Hole Size
Panel Range: .095" - .805"
Head: 23/32" Stem: 1 1/16"
Black Nylon
Shield Retainers
G.M. # 10121502
50 Pcs.

10366PK

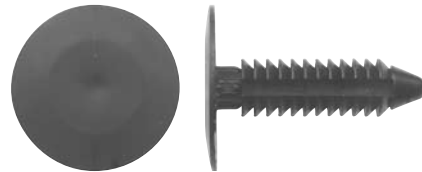

1/4" (6.4mm) Hole Size
Head: 7/8" Stem: 7/16"
Black Nylon
Splash Shield &
Wheel Cover Retainers
G.M. # 22547243
50 Pcs.

5628PK

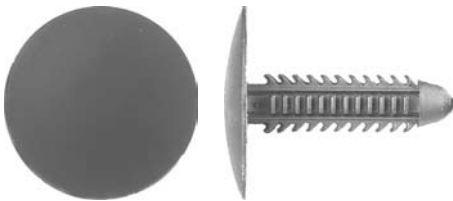

1/4" (6.4mm) Hole Size
Panel Range: .070" - .805"
Head: 1" Stem: 1 1/16"
Black Nylon
Shield Retainers
Chrysler # 6502104
25 Pcs.

5627PK



1/4" (6.4mm) Hole Size
Panel Range: .100" - .685"
Head: 1" Stem: 1 3/32"
Black Nylon
Trim Panel Retainers
Ford # 388930-S
50 Pcs.

9345PK

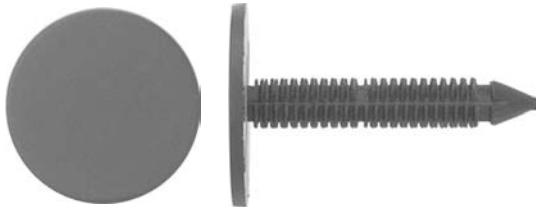

1/4" (6.4mm) Hole Size
 Head Diameter: 1"
 Stem Length: 1 7/16"
 Black Nylon
 Shield Retainers
 G.M. # 14027471
 25 Pcs.

10941PK

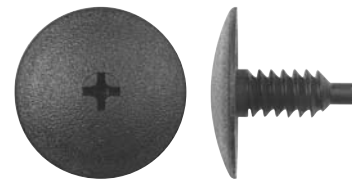

6.5-1.50 x 16mm Screw Size
 Head: 23mm Stem: 18mm
 Phillips Drive Textured Head
 Black Nylon
 Cowl Vent Screws
 V.W. # 1H0-819-055-B-01C
 25 Pcs.

10462PK

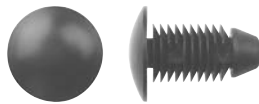

17/64" (7mm) Hole Size
 Panel Range: .8mm - 8mm
 Head: 12.6mm Stem: 15.5mm
 Black Nylon
 Weatherstrip Retainers
 G.M. # 10293193
 50 Pcs.

9485PK

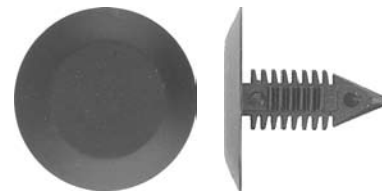

17/64" (7mm) Hole Size
 Head Diameter: 15/16"
 Stem Length: 3/4"
 Black Nylon
 Door Trim Panel Retainers
 Ford # 385661-S
 25 Pcs.

1644PK

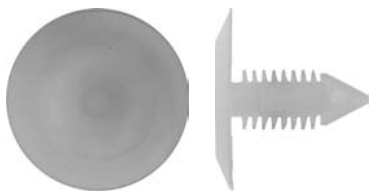

17/64" (7mm) Hole Size
 Head: 15/16" Stem: 3/4"
 Natural Nylon
 Interior Trim
 Panel Retainers
 G.M. # 2048248
 50 Pcs.

9374PK



17/64" (7mm) Hole Size
 Head: 25/32" Stem: 15/64"
 Black Nylon
 Shield Retainers
 G.M. # 20319841
 25 Pcs.

1149PK

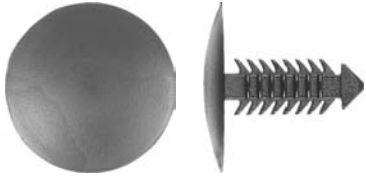

17/64" (7mm) Hole Size
 Panel Range: 2.5mm - 13.5mm
 Head: 25mm Stem: 20.5mm
 Black Nylon
 Door Frame Spacer Retainers
 Ford # 388904-S
 25 Pcs.

9376PK



17/64" (7mm) Hole Size
 Head Diameter: 10mm
 Stem Length: 33.5mm
 Black Nylon
 Bumper Cover Retainers
 G.M.
 25 Pcs.

5635PK

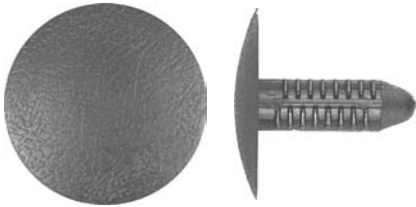

9/32" (7.1mm) Hole Size
 Panel Range: 2.56mm - 12.96mm
 Head : 25mm Stem: 20mm
 Black Nylon
 Interior Trim Retainers
 Ford # N802734S
 50 Pcs.

9849PK

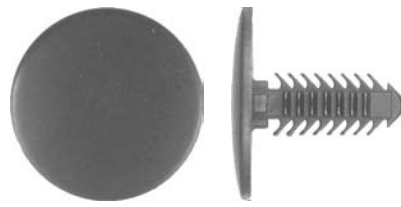

9/32" (7.1mm) Hole Size
 Panel Range: .106 - .540"
 Head: 1" Stem: 27/32"
 Black Nylon
 Fascia Panel Retainers
 Ford # 389443-S
 25 Pcs.

9132PK



9/32" (7.1mm) Hole Size
 Panel Range: .055" - 1.005"
 Head: 3/4" Stem: 1 11/64"
 Black Nylon
 Bumper Fascia Retainers
 G.M. # 10185925
 25 Pcs.

2048PK

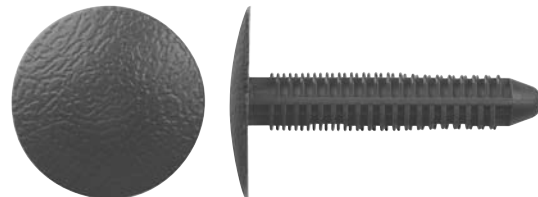

9/32" (7.1mm) Hole Size
 Panel Range: .075" - 1.25"
 Head: 26mm Stem: 38.5mm
 Black Nylon
 Interior Trim Retainers
 Ford # N804349S
 25 Pcs.

JL-120PK

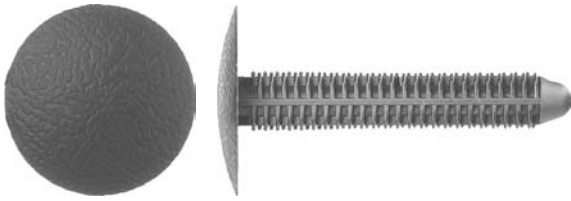

9/32" (7.1mm) Hole Size
 Panel Range: .075" - 1.510"
 Head: 1" Stem: 1 3/4"
 Black Nylon
 Trim Panel Retainers
 Ford # E7EB5802354AAJABH
 25 Pcs.

10517PK

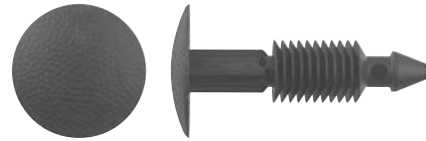

9/32" (7.5mm) Hole Size
 Head Diameter: 18mm
 Stem Length: 32mm
 Black Nylon
 Cowl Vent Retainers
 Ford # W710312-S300
 25 Pcs.

10557PK

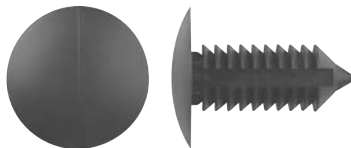

9/32" (7.14mm) Hole Size
 Panel Range: .088" - .650"
 Head: 3/4" Stem: 7/8"
 Black Nylon
 Trim Panel Retainers
 Chrysler
 50 Pcs.

10611PK

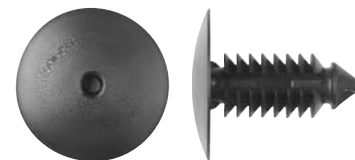

9/32" (7.25mm) Hole Size
 Head Diameter: 20mm
 Stem Length: 21mm
 Black Nylon
 Shield Retainers
 Chrysler # 4860379AA
 25 Pcs.

5640PK

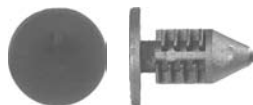

5/16" (7.8mm) Hole Size
 Panel Range: .080" - .270"
 Head: 33/64" Stem: 19/32"
 Black Nylon
 Panel Retainers
 Chrysler # 34202335
 25 Pcs.

9520PK

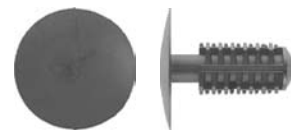

5/16" (7.8mm) Hole Size
 Head Diameter: 5/8"
 Stem Length: 21/32"
 Black Nylon
 Hood Seal Retainers
 G.M. # 22567463
 25 Pcs.

10675PK

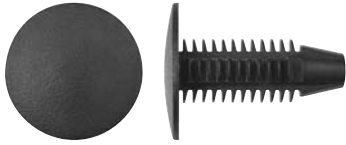

19/64" (7.6mm) Hole Size
 Head Diameter: 18mm
 Stem Length: 22mm
 Black Nylon
 Radiator Side Shield Retainers
 Ford # W701380-SSW
 25 Pcs.

JL-33PK



5/16" (7.8mm) Hole Size
 Panel Range: .078" - .490"
 Head: 3/4" Stem: 31/32"
 Black Nylon
 Trim Panel Retainers
 G.M. # 21094146
 25 Pcs.

8862BPK

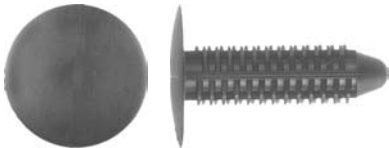

5/16" (7.8mm) Hole Size
 Panel Range: .080" - .800"
 Head: 3/4" Stem: 1 1/16"
 Black Nylon
 Shield Retainers
 G.M. # 15975244
 25 pcs.

5995PK



5/16" (7.8mm) Hole Size
 Panel Range: .060" - 1.025"
 Head: 3/4" Stem: 1 7/16"
 Black Nylon
 Hood Seal Retainers
 G.M. # 14074081
 25 Pcs.

5643PK

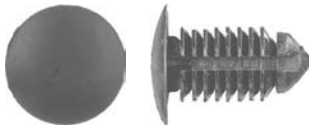

23/64" (9mm) Hole Size
 Panel Range: .060" - .510"
 Head: 16mm Stem: 19.5mm
 Black Nylon
 Trim Panel Retainers
 Ford # N807721-S
 50 Pcs.

10469PK

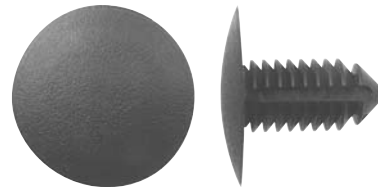

11/32" (9mm) Hole Size
 Panel Range: 1.6mm - 10mm
 Head: 24mm Stem: 20mm
 Black Nylon
 Front End Retainers
 G.M. # 22189414
 25 Pcs.

9352PK

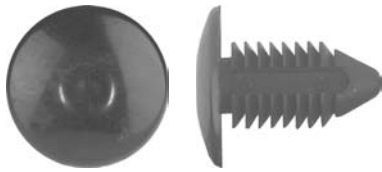

3/8" (9.5mm) Hole Size
 Head Diameter: 7/8"
 Stem Length: 57/64"
 Black Nylon
 Front End Stone Shield Retainers
 G.M. # 22512276
 25 Pcs.

5710PK

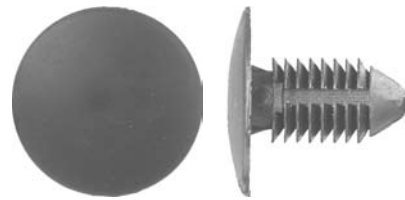

3/8" (9.5mm) Hole Size
 Panel Range: .115" - .565"
 Head: 1" Stem: 27/32"
 Black Nylon
 Panel Retainers
 G.M. # 1619321
 25 Pcs.

5648PK

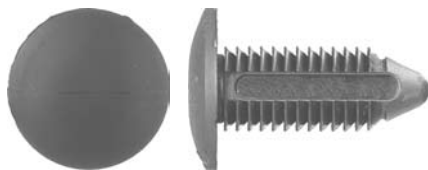

25/64" (10mm) Hole Size
 Panel Range: .040" - .787"
 Head: 22mm Stem: 30mm
 Black Nylon
 Fascia Bumper Retainers
 Ford # N804379S
 50 Pcs.

9493PK



13/32" (10.4mm) Hole Size
 Head Diameter: 25.5mm
 Stem Length: 37.5mm
 Black Nylon
 Firewall Insulation Retainers
 G.M. # 7642589
 25 Pcs.

10672PK

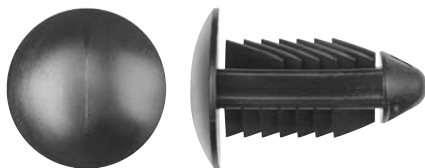

13/32" (10.5mm) Hole Size
 Head Diameter: 21.5mm
 Stem Length: 28mm
 Black Nylon
 Bumper Fascia Retainers
 G.M. # 11518201
 15 Pcs.

9763PK

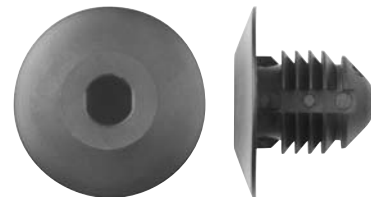

1/2" (12.5mm) Hole Size
 Panel Range: 3.2mm - 5mm
 Head: 25mm Stem: 15mm
 Black Nylon
 Bumper Fascia Retainers
 G.M. # 15056810
 25 Pcs.

4

10734PK

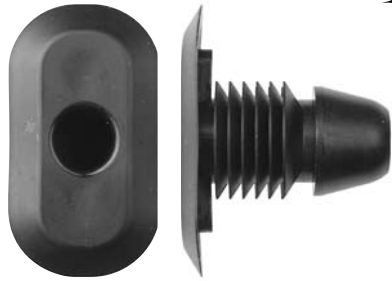

5/8" (16mm) Slotted Hole
 Head Diameter: 19.8mm x 36mm
 Stem Length: 25mm
 Black Nylon
 Bumper Retainers
 G.M.
 5 Pcs.

10539PK

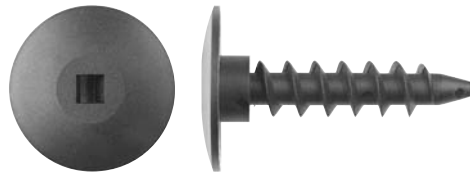

7.5mm x 35mm
 Square Drive Truss Head
 Head: 22mm Stem: 34mm
 Black Nylon
 Bumper Fascia Screws
 Chrysler # 6503819
 15 Pcs.

10665PK

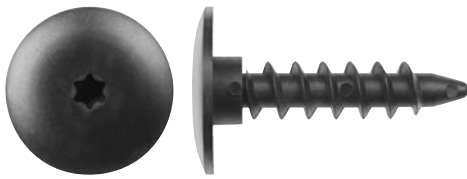

T25 Torx Drive
 Head Diameter: 22mm
 Stem Length: 34mm
 Black Nylon
 Bumper Cover Retainers
 Chrysler # 6507866AA
 25 Pcs.

10566PK

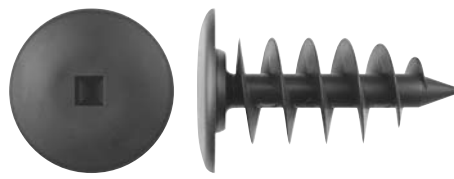

12mm Hole Size
 #3 Square Drive
 Head: 22mm Stem: 34mm
 Black Nylon
 Bumper & Door Insulator Screws
 25 Pcs.

9195PK

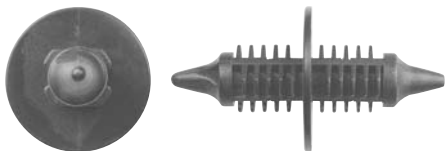

5/16" (7.9mm) Hole Size
 Washer O.D.: 3/4"
 O.A. Length: 1 7/16"
 Black Nylon
 Radiator Grille Retainers
 G.M. # 15672328
 25 Pcs.

10613PK

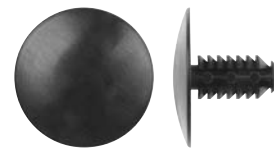

4.75mm Hole Size
 Head Diameter: 19mm
 Stem Length: 12mm
 Black Nylon
 Hood Insulation Retainers
 Ford: # W701374-S
 25 Pcs.

2025PK

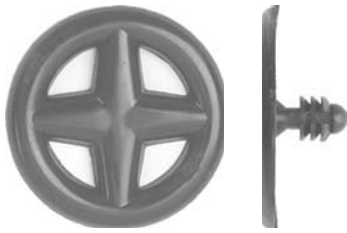

3/16" (5mm) Hole Size
 Head Diameter: 30mm
 Stem Length: 9mm
 Black Nylon
 Hood Insulation Retainers
 Nissan # 65846-30F00
 15 Pcs.

9522PK



15/64" (6mm) Hole Size
 Head Diameter: 14mm
 Stem Length: 10mm
 Black Nylon
 Hood Insulation Retainers
 Ford # F1CZ-16774-A
 25 Pcs.

10379PK

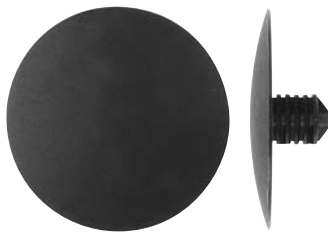

15/64" (6mm) Hole Size
 Head Diameter: 30mm
 Stem Length: 9mm
 Black Nylon
 Hood Insulation Retainers
 Honda # 90700-SB2-003
 15 Pcs.

9980PK

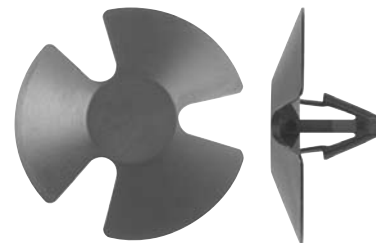

1/4" (6.3mm) Hole Size
 Head Diameter: 30mm
 Stem Length: 13mm
 Black Nylon
 Hood Insulation Retainer
 Chrysler # 4878883AA
 50 Pcs.

2167PK

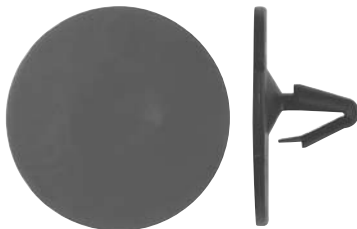

1/4" (6.3mm) Hole Size
 Head Diameter: 30mm
 Stem Length: 12.5mm
 Black Nylon
 Hood Insulation Retainers
 G.M. # 21039129
 50 Pcs.

969PK

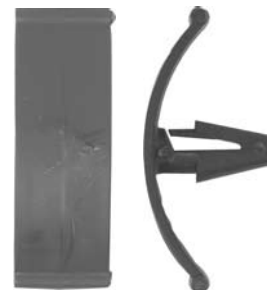

1/4" (6.4mm) Hole Size
 Head Dia.: 1/2" x 1 1/2"
 Stem Length: 5/8"
 Black Nylon
 Hood Insulation Retainers
 Ford # 385330-S
 25 Pcs.

1865PK

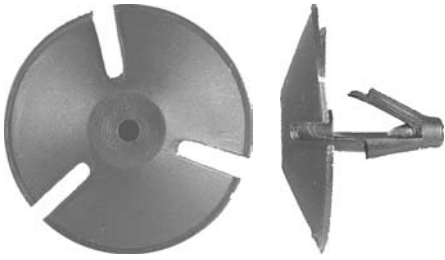

1/4" (6.4mm) Hole Size
Head Diameter: 1 5/16"
Stem Length: 13/16"
Black Nylon
Hood Insulation Retainers
Chrysler # 4341060
25 Pcs.

2111PK

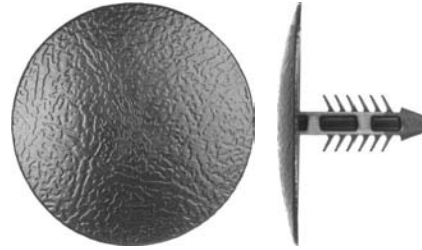

1/4" (6.3mm) Hole Size
Head Diameter: 32mm
Stem Length: 18mm
Black Nylon
Hood Insulation Retainers
Ford # N808842-S
50 Pcs.

9588PK

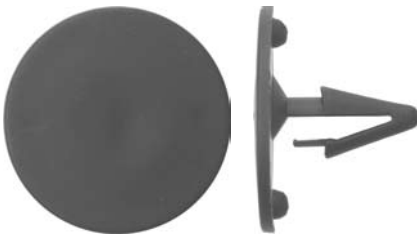

1/4" (6.4mm) Hole Size
Head Diameter: 1 3/16"
Stem Length: 3/4"
Black Nylon
Hood Insulation Retainers
Ford # 386553-S
50 Pcs.

1930PK



1/4" (6.4mm) Hole Size
Head: 1 5/8" Stem: 3/4"
Black Nylon
Hood Insulation Retainers
G.M. # 20064875
25 Pcs.

1573PK

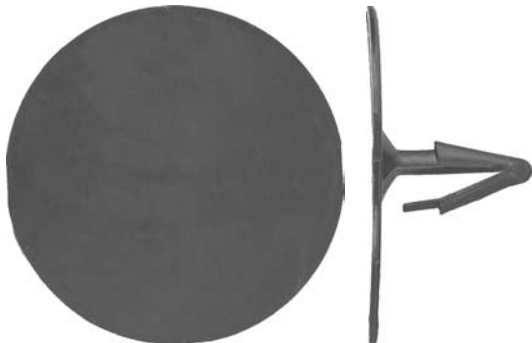

1/4" (6.4mm) Hole Size
Head: 1 3/4" Stem: 3/4"
Black Nylon
Hood Insulation Retainers
Ford # 388908-S
50 Pcs.

5440PK

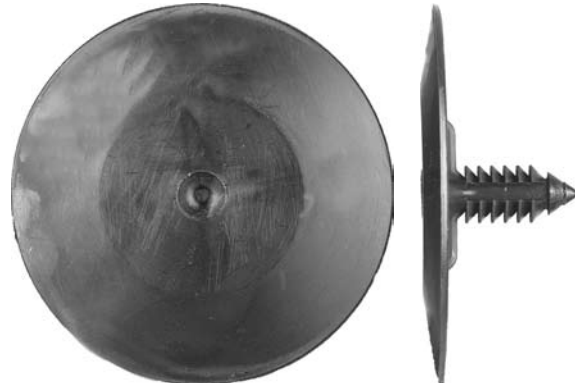

1/4" (6.4mm) Hole Size Head: 2"
Black Polypropylene
Hood Insulation Retainers
G.M. # 3078511
25 Pcs.

10670PK

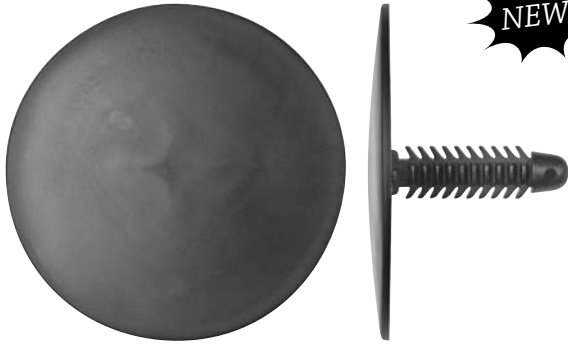

NEW!

1/4" (6.4mm) Hole Size
Head: 1 3/4" Stem: 1"
Black Nylon
Trim Panel Retainers
Ford # N803387
25 Pcs.

9513PK

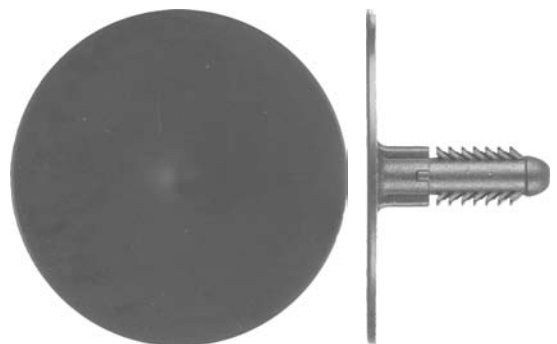

1/4" (6.4mm) Hole Size
Head: 1 3/4" Stem: 7/8"
Black Nylon
Hood Insulation Retainers
Ford # N803613S
25 Pcs.

10141PK

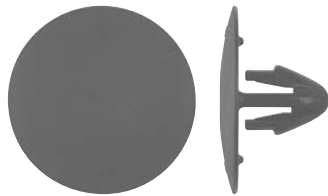

17/64" (7mm) Hole Size
Head Diameter: 25mm
Stem Length: 10mm
Black Nylon
Hood Insulation Retainers
Toyota # 90467-09050
15 Pcs.

9403PK



NEW!

17/64" (7mm) Hole Size
Head Diameter: 25mm
Stem Length: 12mm
Black Nylon
Hood Insulation Retainers
Toyota # 90467-08124
15 Pcs.

1929PK



17/64" (7mm) Hole Size
Head: 35mm Stem: 25mm
Black Polypropylene
Hood Insulation Retainers
G.M. # 200300401
25 Pcs.

10435PK



NEW!

17/64" (7mm) Hole Size
Head Diameter: 30mm
Stem Length: 14mm
Black Nylon
Hood Insulation Retainers
Honda # 91501-S1K-003
25 Pcs.

9328PK



17/64" (7mm) Hole Size
 Head Diameter: 30mm
 Stem Length: 17mm
 Black Nylon
 Hood Insulation Retainers
 Toyota # 90467-09006
 15 Pcs.

1950PK



17/64" (7mm) Hole Size
 Head Diameter: 30mm
 Stem Length: 17mm
 Black Nylon
 Retaining Retainers
 Toyota # 90467-09008
 25 Pcs.

10393PK

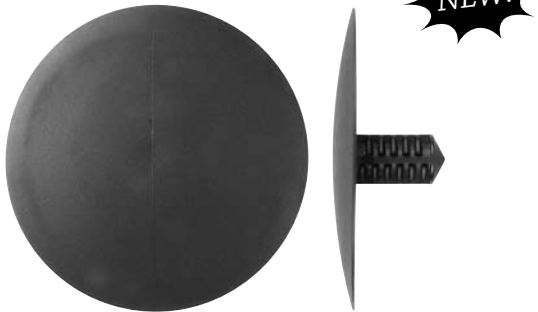

9/32" (7.1mm) Hole Size
 Head: 40mm Stem: 13mm
 Black Nylon
 Hood Insulation Retainers
 G.M. # 21039141
 25 Pcs.

9945PK

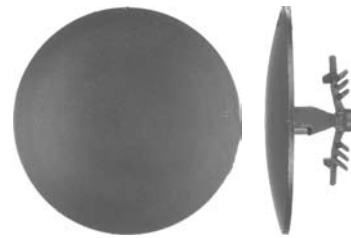

9/32" (7.5mm) Hole Size
 Head Diameter: 30mm
 Stem Length: 10mm
 Black Nylon
 Hood Insulation Retainers
 Acura # 90700-SJ4-000
 15 Pcs.

10782PK

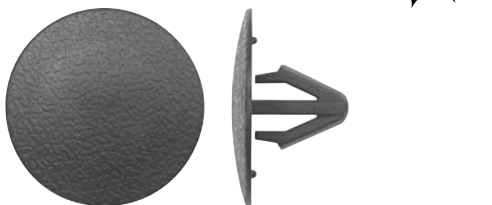

5/16" (8mm) Hole Size
 Head Diameter: 26mm
 Stem Length: 14mm
 Black Nylon
 Hood Insulation Retainers
 Hyundai # 81126-37010
 15 Pcs.

10677PK

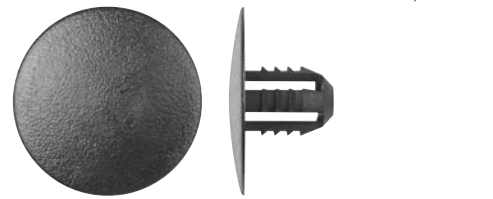

21/64" (8.5mm) Hole Size
 Head Diameter: 25mm
 Stem Length: 12.5mm
 Black Nylon
 Hood Insulation Retainers
 Ford # W700671-S300
 25 Pcs.

10944PK

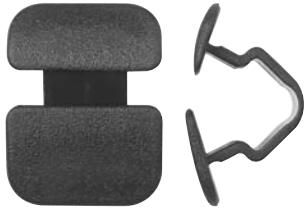

15/32" (12mm) Hole Size
 Head Dia.: 20mm x 25mm
 Stem Length: 13mm
 Black Nylon
 Hood Insulation Retainers
 V.W. # 1H5-863-849-01C
 15 Pcs.

10953PK



15/32" (12mm) Hole Size
 Head Dia.: 30mm x 23mm
 Stem Length: 13mm
 Black Nylon
 Hood Insulation Retainers
 V.W. # 867-863-849-A01C
 15 Pcs.

10662PK



1/8" (3.3mm) Hole Size
 Head Dia.: 6mm x 12mm
 Stem Length: 9.6mm
 Black Nylon
 Weatherstrip Retainers
 Chrysler
 100 Pcs.

1991PK



3/16" (4.5mm) Hole Size
 Head Dia.: 4.75mm x 13.5mm
 Stem Length: 12mm
 Black Nylon
 Weatherstrip Retainers
 G.M. # 4876498
 100 Pcs.

9875PK



3/16" (4.5mm) Hole Size
 Head Dia.: 5mm x 13mm
 Stem Length: 16mm
 Natural Nylon
 Weatherstrip Retainers
 Ford # C5AB-6220586A
 50 Pcs.

10929PK



3/16" (4.5mm) Hole Size
 Head Dia.: 5mm x 13mm
 Stem Length: 10mm
 Black Nylon
 Weatherstrip Retainers
 V.W. # 251-823-717
 25 Pcs.

4

4

10657PK



11/64" (4.2mm) Hole Size
 Head Diameter: 11mm
 Stem Length: 12mm
 Black Nylon
 Weatherstrip Retainers
 G.M. # 20538173
 50 Pcs.

10501PK

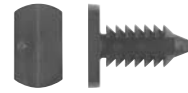

3/16" (4.8mm) Hole
 Head Dia.: 6.5mm x 11mm
 Stem Length: 12.2mm
 Black Nylon
 Weatherstrip Retainers
 Chrysler
 100 Pcs.

2016PK



13/64" (5mm) Hole Size
 Head Dia.: 6.5mm x 16.5mm
 Stem Length: 10.5mm
 White Nylon
 Weatherstrip Retainers
 Chrysler # 4696129
 50 Pcs.

10577PK

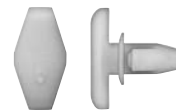

13/64" (5mm) Hole Size
 Head Dia.: 7mm x 14mm
 Stem Length: 10.5mm
 Natural Nylon
 Weatherstrip Retainers
 Chrysler
 50 Pcs.

10388PK

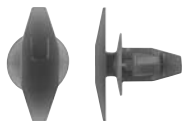

13/64" (5mm) Hole Size
 Head Dia.: 5mm x 15mm
 Stem Length: 10mm
 Green Nylon
 Weatherstrip Retainers
 Honda # 91568-SR2-003
 100 Pcs.

10521PK

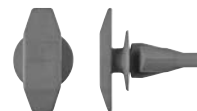

13/64" (5mm) Hole Size
 Head Dia.: 5mm x 14mm
 Stem Length: 10mm
 Blue Nylon
 Weatherstrip Retainers
 Ford
 100 Pcs.

10513PK

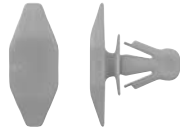

13/64" (5mm) Hole Size
 Head Dia.: 6.5mm x 16.5mm
 Stem Length: 8mm
 White Nylon
 Weatherstrip Retainers
 Chrysler
 100 Pcs.

9560PK

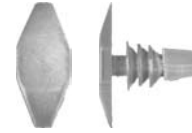

13/64" (5mm) Hole Size
 Head Dia.: 7mm x 16mm
 Stem Length: 10mm
 Natural Nylon
 Weatherstrip Retainers
 Honda # 90664-671-0030
 50 Pcs.

10663PK

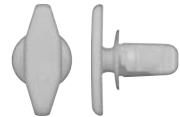

13/64" (5mm) Hole Size
 Head Dia.: 5mm x 15mm
 Stem Length: 7.8mm
 Yellow Nylon
 Weatherstrip Retainers
 Acura, Ford, Honda
 100 Pcs.

10664PK



13/64" (5mm) Hole Size
 Top Head Dia.: 10.9mm
 Stem Length: 10.5mm
 Natural Nylon
 Weatherstrip Retainers
 G.M.
 50 Pcs.

10578PK

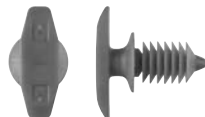

13/64" (5mm) Hole Size
 Head Dia.: 5mm x 15mm
 Stem Length: 13.10mm
 Green Nylon
 Weatherstrip Retainers
 Chrysler
 50 Pcs.

10661PK



13/64" (5mm) Hole Size
 Head Dia.: 5mm x 15mm
 Yellow Nylon
 Door & Hood Seal
 Weatherstrip Retainers
 Ford
 100 Pcs.

4

10506PK

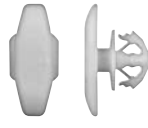

5.8mm Hole Size
Head Dia.: 5mm x 15mm
Stem Length: 7mm
Natural Nylon
Weatherstrip Retainers
Chrysler
100 Pcs.

9264PK



15/64" (6mm) Hole Size
Head Dia.: 5.25mm x 14.2mm
Stem Length: 12.3mm
Black Nylon
Weatherstrip Retainers
Ford
50 Pcs.

9208PK



15/64" (6mm) Hole Size
Head Dia.: 5mm x 15mm
Stem Length: 10mm
Orange Nylon
Weatherstrip Retainers
Honda # 91530-SP1-003
25 Pcs.

9336PK

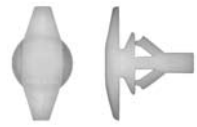

15/64" (6mm) Hole Size
Head Dia.: 5mm x 15mm
Stem Length: 10mm
Natural Nylon
Weatherstrip Retainers
Honda # 91530-ST5-003
10 Pcs.

10766PK

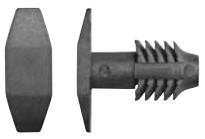

6.5mm Hole Size
Head Dia.: 6mm x 16mm
Stem Length: 14mm
Black Nylon
Hood Weatherstrip Retainers
Hyundai # 86434-4A000
50 Pcs.

10767PK

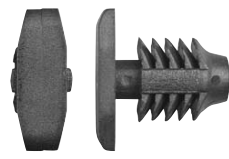

6.5mm Hole Size
Head Dia.: 4.6mm x 13mm
Stem Length: 11mm
Black Nylon
Hood W/Strip Moulding Clips
Hyundia # 8438-4A100
100 Pcs.

10567PK



6.8mm Hole Size
 Head Diameter: 9mm
 Stem Length: 14.5mm
 Yellow Nylon
 Weatherstrip Retainers
 Ford
 100 Pcs.

10660PK



5/16" (8mm) Hole Size
 Head Diameter: 16mm
 Stem Length: 9.3mm
 Black Nylon
 Weatherstrip Retainers
 G.M.
 50 Pcs.

9074PK



13/64" (5mm) Hole Size
 Panel Thickness: 3mm
 Head: 14mm Stem: 10mm
 Black Nylon
 Panel Retainers
 Toyota # 90467-06161-01
 25 Pcs.

1996PK



13/64" (5mm) Hole Size
 Head Diameter: 13mm
 Stem Length: 11mm
 Black Nylon
 Retaining Clips
 Toyota # 90467-08004
 50 Pcs.

1466PK



13/64" (5mm) Hole Size
 Head Diameter: 13mm
 Stem Length: 15mm
 Black Nylon
 Retaining Clips
 Toyota # 90467-07050
 25 Pcs.

9554PK



13/64" (5mm) Hole Size
 Panel Thickness: 4mm
 Head: 13mm Stem: 15mm
 Black Nylon
 Retaining Clips
 Honda # 90687-SA5-0030
 50 Pcs.

4

4

10415PK

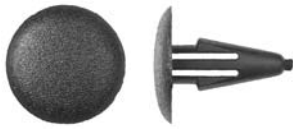

13/64" (5mm) Hole Size
 Head Diameter: 16mm
 Stem Length: 15mm
 Black Nylon
 Retaining Clips
 Nissan # 27948-M7002
 25 Pcs.

10411PK



15/64" (6mm) Hole Size
 Head Diameter: 14mm
 Stem Length: 11mm
 Black Nylon
 Retaining Clips
 Nissan # 62869-N4700
 25 Pcs.

9886PK



7/32" (5.5mm) Hole Size
 Panel Range: 5mm
 Head: 11mm Stem: 15mm
 Black Nylon
 Retaining Clips
 Nissan # 01553-00291
 50 Pcs.

5606PK



15/64" (6mm) Hole Size
 Panel Range: 4mm
 Head: 10mm Stem: 10mm
 Black Nylon
 Hood Moulding Retainers
 Honda # 91520-SM4-C010
 25 Pcs.

9262PK



15/64" (6mm) Hole Size
 Panel Range: 9mm
 Head: 12mm Stem: 9mm
 Black Nylon
 Hood & Trunk Moulding Retainers
 Honda # 91518-SM4-003
 10 Pcs.

1634PK



15/64" (6mm) Hole Size
 Panel Range: 5mm
 Head: 14mm Stem: 16mm
 Black Nylon
 Retaining Clips
 Nissan # 76906-T3000
 50 Pcs.

2002PK



15/64" (6mm) Hole Size
 Head Diameter: 14mm
 Stem Length: 15mm
 Black Nylon
 Cowl Top Retaining Clips
 Honda # 91501-SM4-003
 15 Pcs.

9977PK

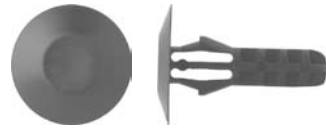

1/4" (6mm) Hole Size
 Head Diameter: 16mm
 Stem Length: 21mm
 Black Nylon
 Bumper Retainers
 Honda # 90108-SW3-003
 15 Pcs.

10417PK

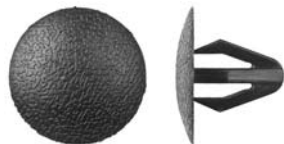

17/64" (7mm) Hole Size
 Head Diameter: 18mm
 Stem Length: 12mm
 Black Nylon
 Retaining Clips
 Nissan # 01553-00202
 50 Pcs.

10408PK



17/64" (7mm) Hole Size
 Head Diameter: 18mm
 Stem Length: 15mm
 Black Nylon
 Retaining Clips
 Honda # 38529-689A-6300
 25 Pcs.

1579PK

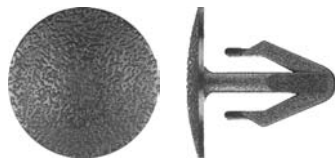

17/64" (7mm) Hole Size
 Panel Range: 7mm
 Head: 20mm Stem: 16mm
 Black Nylon
 Retaining Clips
 Nissan # 01553-00051
 50 Pcs.

10416PK



17/64" (7mm) Hole Size
 Head Diameter: 15mm
 Stem Length: 20mm
 Black Nylon
 Retaining Clips
 Honda # 90670-692-0030
 25 Pcs.

4

9901PK

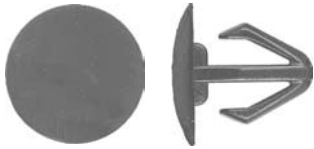

5/16" (8mm) Hole Size
 Panel Range: 5mm
 Head: 18mm Stem: 15mm
 Black Nylon
 Retaining Clips
 Mitsubishi # HB-121467
 25 Pcs.

10414PK



5/16" (8mm) Hole Size
 Head Diameter: 15mm
 Stem Length: 15mm
 Black Nylon
 Retaining Clips
 Toyota # 90950-01248
 25 Pcs.

10407PK

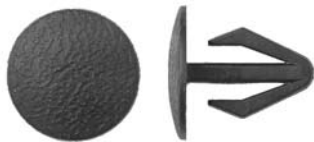

5/16" (8mm) Hole Size
 Head Diameter: 18mm
 Stem Length: 18mm
 Black Nylon
 Retaining Clips
 Mazda # 8133-50-022
 25 Pcs.

9864PK

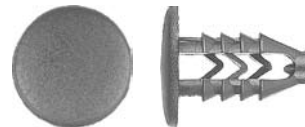

5/16" (8mm) Hole Size
 Head Diameter: 16mm
 Stem Length: 18mm
 Black Nylon
 Interior Trim Retainers
 Fiat # 4-29-29-06
 50 Pcs.

10412PK



25/64" (10mm) Hole Size
 Head Diameter: 20mm
 Stem Length: 20mm
 Black Nylon
 Retaining Clips
 Honda # 90687-671-0030
 25 Pcs.

1310PK



13/64" (5mm) Hole Size
 Head Diameter: 3/8"
 Stem Length: 15/32"
 Black Nylon
 Tail Light Retainers
 G.M. # 16500308
 25 Pcs.

9859PK



13/64" (5mm) Hole Size
 Flange Diameter: 7mm
 Stem Length: 10mm
 Black Nylon Door Handle
 Push Type Retainers
 G.M. # 21097229
 25 Pcs.

1756PK



15/64" (6mm) Square Hole Size
 Flange Dia.: 8mm x 12mm
 Stem Length: 8mm
 Black Nylon
 Cowl Grille Retainers
 Nissan # 66814-01G00
 25 Pcs.

10656PK



15/64" (6mm) Hole Size
 Flange Diameter: 12mm
 Stem Length: 8mm
 Black Nylon
 Push Type Retainers
 Nissan # 66824-01G00
 25 Pcs.

9617PK



15/64" (6mm) Hole Size
 Flange: 17mm Stem: 16mm
 Black Nylon
 Radiator, Wheelhouse & Fender
 Push Type Retainers
 G.M. # 15149708
 25 Pcs.

9320PK



15/64" (6mm) Hole Size
 Flange Diameter: 15mm
 Stem Length: 23mm
 Black Nylon
 Fascia Retainers
 G.M. # 15681408
 50 Pcs.

10797PK



1/4" (6.3mm) Hole Size
 Flange: 15mm Stem: 12mm
 Black Nylon
 Interior Trim, Bumper &
 Grille Retainers
 Mitsubishi # MB619582
 25 Pcs.

4

10655PK



1/4" (6.3mm) Hole Size
 Flange Diameter: 15mm
 Stem Length: 13mm
 Black Nylon
 Push Type Retainers
 G.M. # 96057846
 10 Pcs.

10423PK

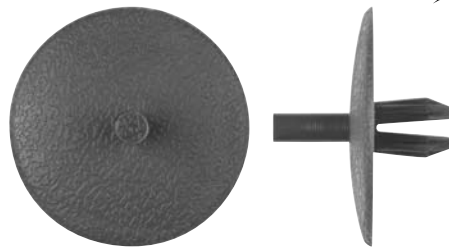

1/4" (6.3mm) Hole Size
 Flange Diameter: 1 1/4"
 Stem Length: 7/16"
 Grey Nylon
 Headliner Retainers
 Chrysler # OH452KD5
 15 Pcs.

9046PK



1/4" (6.4mm) Hole Size
 Textured Head
 Black Nylon
 Instrument Panel
 Grille Retainers
 15 Pcs.

9559PK



1/4" (6.4mm) Hole Size
 Flange: 19/32" Stem: 3/4"
 Black Nylon
 Wheel Opening Moulding
 Push Type Retainers
 G.M. # 21077123
 25 Pcs.

5675PK



1/4" (6.4mm) Hole Size
 Panel Range: 9/16"
 Flange: 11/16" Stem: 9/16"
 Black Nylon
 Mud Skirt Blind Rivets
 G.M. # 14019205
 50 Pcs.

2045PK



1/4" (6.4mm) Hole Size
 Flange Diameter: 11/16"
 Stem Length: 13/16"
 Black Nylon
 Push Type Retainers
 Chrysler # 6501925
 25 Pcs.

9369PK



1/4" (6.4mm) Hole Size
 Flange Diameter: 11/16"
 Stem Length: 29/32"
 Black Nylon
 Exterior Body Retainers
 G.M. # 20590899
 25 Pcs.

1087PK



1/4" (6.4mm) Hole Size
 Flange Diameter: 11/16"
 Stem Length: 5/8"
 Black Nylon
 Push Type Retainers
 G.M. # 472434
 50 Pcs.

9858PK



1/4" (6.4mm) Wide Slot
 Flange Diameter: 3/4"
 Stem Length: 11/16"
 Black Nylon
 Grille Retainers
 Ford # 387944-S
 50 Pcs.

9745PK



1/4" (6.4mm) Hole Size
 Flange Diameter: 3/4"
 Stem Length: 1 1/8"
 Black Nylon
 Push Type Retainers
 G.M. # 3540858
 25 Pcs.

5935PK

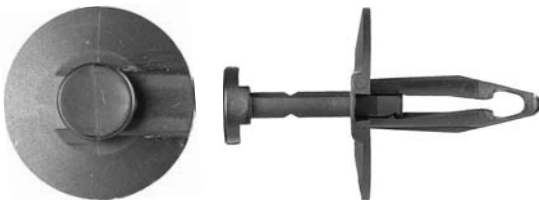

1/4" (6.4mm) Hole Size
 Panel Range: .098" - .350"
 Flange: 1" Stem: 29/32"
 Black Nylon
 Splash Shield Blind Rivets
 G.M. # 14093088
 25 Pcs.

10505PK



1/4" (6.4mm) Hole Size
 Head Diameter: 7/8"
 Stem Length: 1"
 Black Nylon
 Lower Sill Moulding Retainers
 Chrysler # 6503106
 15 Pcs.

10368PK

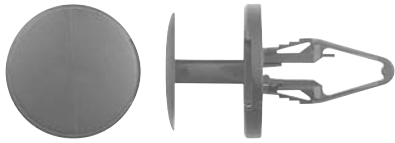

17/64" (6.5mm) Hole Size
 Panel Range: 2mm - 4.5mm
 Flange Diameter: 18mm
 Black Nylon
 Push Type Retainers
 G.M. # 11589289
 25 Pcs.

10369PK



17/64" (6.5mm) Hole Size
 Panel Range: 4.5mm - 7mm
 Flange: 18mm Stem: 20mm
 Black Nylon
 Push Type Retainers
 G.M. # 11589290
 50 Pcs.

10367PK



17/64" (6.5mm) Hole Size
 Panel Range: 7mm - 9.5mm
 Flange: 14mm Stem: 22mm
 Black Nylon
 Push Type Retainers
 G.M. # 11589291
 25 Pcs.

10537PK



17/64" (6.5mm) Hole Size
 Flange Diameter: 18mm
 Stem Length: 7mm
 Black Nylon
 Fender Liner Retainers
 Toyota # 53879-60010
 15 Pcs.

10825PK



17/64" (6.5mm) Hole Size
 Flange Diameter: 15mm
 Stem Length: 14mm
 Black Nylon
 Cowl Vent Retainers
 Toyota # 90467-07192
 15 Pcs.

9114PK



17/64" (7mm) Hole Size
 Flange Diameter: 18mm
 Stem Length: 16mm
 Black Nylon
 Push Type Retainers
 Nissan # 80999-05N07
 25 Pcs.

9465PK



17/64" (7mm) Hole Size
 Flange: 20mm Stem: 10mm
 Black Nylon
 Front Fender Liner
 Push Type Retainers
 Toyota # 90467-07166
 15 Pcs.

10623PK



17/64" (7mm) Hole Size
 Flange Diameter: 15mm
 Stem Length: 17mm
 Black Nylon
 Push Type Retainers
 Toyota # 90467-07188
 15 Pcs.

10512PK

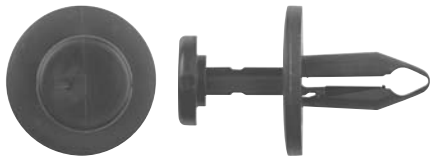

17/64" (7mm) Hole Size
 Flange Diameter: 20mm
 Stem Length: 17mm
 Black Nylon
 Side Radiator Shield Retainers
 Chrysler # 6506132-AA
 25 Pcs.

5676PK



5/16" (7.8mm) Hole Size
 Flange: 17mm Stem: 13.5mm
 Black Nylon
 Radiator & Windshield
 Bottle Retainers
 G.M. # 14071289
 25 Pcs.

10940PK



5/16" (8mm) Hole Size
 Flange: 12.5mm Stem: 11mm
 Black Nylon
 Fender Splash Shield, Hood &
 Truck Insulator Rivets
 V.W. # N0385501
 25 Pcs.

10948PK



5/16" (8mm) Hole Size
 Flange Diameter: 16mm
 Stem Length: 11mm
 Black Nylon
 Push Type Retainers
 V.W. #161-867-299-01C
 25 Pcs.

10616PK



5/16" (8mm) Hole Size
 Flange: 20mm Stem: 13mm
 Black Nylon
 Front Bumper &
 Radiator Support Retainers
 Nissan # 11296-AG000
 25 Pcs.

9540PK

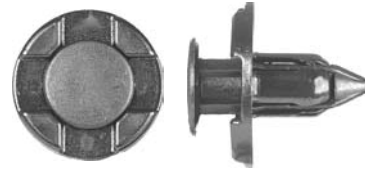

5/16" (8mm) Hole Size
 Flange Diameter: 20mm
 Stem Length: 13mm
 Black Nylon
 Push Type Retainers
 Nissan # 01553-09321
 15 Pcs.

10536PK



5/16" (8mm) Hole Size
 Head Diameter: 18mm
 Stem Length: 12mm
 Black Nylon
 Bumper Clip Retainers
 Nissan # 01553-09611
 15 Pcs.

9292PK



5/16" (8mm) Hole Size
 Flange: 20mm Stem: 10mm
 Black Nylon
 Front Fender
 Push Type Retainers
 Honda 91501-S04-003
 15 Pcs.

2128PK



5/16" (8mm) Hole Size
 Flange Diameter: 20mm
 Stem Length: 11mm
 Black Nylon
 Push Type Retainers
 Acura # 91512-SX0-003
 25 Pcs.

2057PK



5/16" (8mm) Hole Size
 Head: 18mm Stem: 14mm
 Black Nylon With Sealer
 Cowl Panel
 Push Type Retainers
 Honda # 91508-SM4-003
 10 Pcs.

10798PK

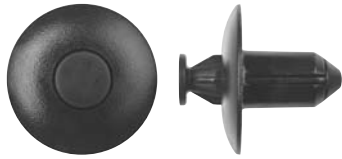

5/16" (8mm) Hole Size
 Flange: 20mm Stem: 14mm
 Black Nylon
 Front Bumper
 Push Type Retainers
 Nissan # 01553-09431
 15 Pcs.

9390PK



5/16" (8mm) Hole Size
 Flange Diameter: 20mm
 Stem Length: 14mm
 Black Nylon
 Push Type Retainers
 Honda # 91545-SE0-0030-W1
 25 Pcs.

2056PK

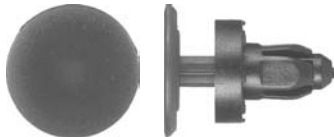

5/16" (8mm) Hole Size
 Head: 17mm Stem: 11mm
 Black Nylon
 Cowl Panel
 Push Type Retainers
 Honda # 91508-SR3-000
 10 Pcs.

1975PK



5/16" (8mm) Hole Size
 Flange Diameter: 16mm
 Stem Length: 20mm
 Black Nylon
 Push Type Retainers
 Nissan # 76882-57A00
 25 Pcs.

1949PK



5/16" (8mm) Hole Size
 Flange: 20mm Stem: 15mm
 Black Nylon
 Front & Rear Bumper Cover
 Push Type Retainers
 Nissan # 01553-06721
 15 Pcs.

1861PK



5/16" (8mm) Hole Size
 Flange Diameter: 15mm
 Stem Length: 20mm
 Black Nylon
 Rocker Panel Retainers
 G.M. # 21075686
 25 Pcs.

10511PK



5/16" (8mm) Hole Size
 Flange Diameter: 18mm
 Stem Length: 20mm
 Black Nylon
 Rear Bumper Retainers
 Chrysler # 5160260AA
 15 Pcs.

1860PK

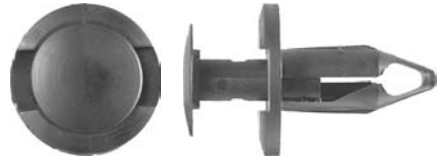

5/16" (8mm) Hole Size
 Flange Diameter: 20mm
 Stem Length: 20mm
 Black Nylon
 Push Type Retainers
 G.M. # 21030249
 25 Pcs.

5940PK

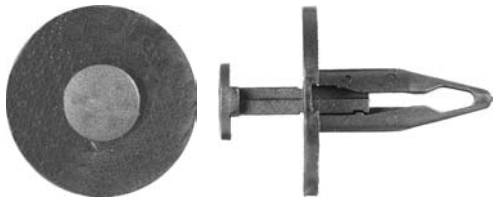

5/16" (8mm) Hole Size
 Panel Range: 3.5mm - 7.9mm
 Flange: 25mm Stem: 23mm
 Black Nylon
 Spare Tire Blind Rivets
 G.M. # 20570245
 25 Pcs.

1263PK

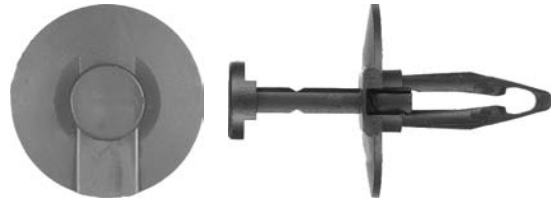

5/16" (8mm) Hole Size
 Flange: 1" Shoulder: 7/64"
 Stem Length: 29/32"
 Black Nylon
 Splash Shield & Fascia Ret.
 Ford # N803421-S
 25 Pcs.

2133PK



5/16" (8mm) Hole Size
 Flange Diameter: 18mm
 Stem Length: 23mm
 Black Nylon
 Fascia Push Type Retainers
 Chrysler # 6504521
 25 Pcs.

10075PK

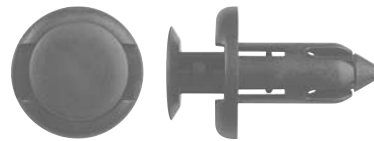

5/16" (8mm) Hole Size
 Flange: 18mm Stem: 19mm
 Black Nylon
 Garnish Side Protector
 Push Type Retainers
 Honda # 90505-SX0-003
 15 Pcs.

10370PK

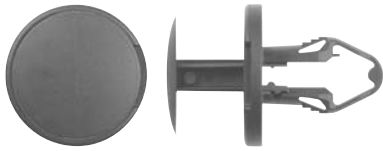

5/16" (8mm) Hole Size
 Panel Range: 5mm - 7mm
 Flange: 19mm Stem: 16mm
 Black Nylon
 Push Type Retainers
 G.M. # 15296830
 25 Pcs.

10503PK



5/16" (8mm) Hole Size
 Flange Diameter: 18.5mm
 Stem Length: 21mm
 Black Nylon With Sealer
 Rear Bumper Retainers
 Chrysler # 4806240AA
 10 Pcs.

10504PK



5/16" (8mm) Hole Size
 Flange Diameter: 20mm
 Stem Length: 26mm
 Black Nylon
 Fender Shield Retainers
 G.M. # 11518017
 15 Pcs.

10669PK



5/16" (8mm) Hole Size
 Flange: 16.5mm Stem: 27mm
 Black Nylon
 Bumper & Rear Wheel Apron
 Push Type Retainers
 G.M. # 15994165
 25 Pcs.

9357PK



5/16" (8mm) Hole Size
 Flange Diameter: 20mm
 Stem Length: 28mm
 Black Nylon
 Bumper Facia Retainers
 G.M. # 21095797
 25 Pcs.

10673PK

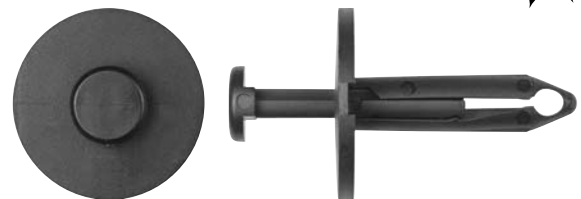

5/16" (8mm) Hole Size
 Flange Diameter: 25mm
 Stem Length: 30mm
 Black Nylon
 Bumper Cover Retainers
 Nissan # 622A2-9E000A
 10 Pcs.

4

10496PK

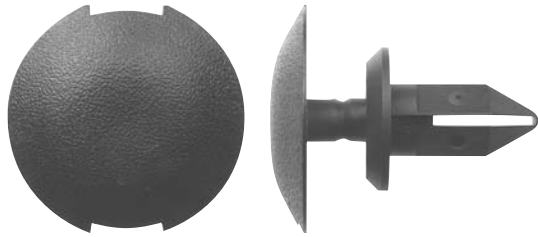

5/16" (8mm) Square Hole Size
 Head Diameter: 31mm
 Stem Length: 21mm
 Black Nylon
 Tail Light Retainers
 Chrysler # 55157330-AC
 15 Pcs.

10460PK

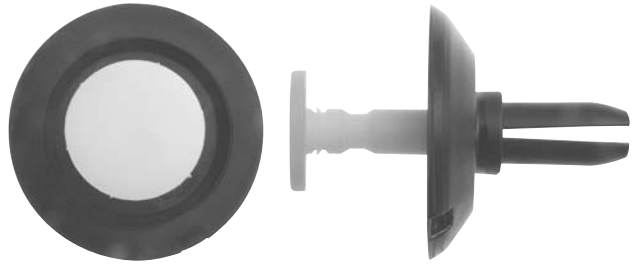

5/16" (8mm) Hole Size
 Flange: 34mm Shoulder: 3.5mm
 Stem Length: 20.5mm
 Black & Natural Nylon
 Front Bumper Fascia Retainers
 Chrysler # 4805405AA
 15 Pcs.

10928PK



11/32" (8.5mm) Hole Size
 Flange Diameter: 16mm
 Stem Length: 13.5mm
 Black Nylon
 Push Type Retainers
 V.W. # 161-867-299
 50 Pcs.

10239PK



21/64" (8.5mm) Hole Size
 Panel Range: 2.7mm - 5.3mm
 Flange: 19mm Stem: 14mm
 Black Nylon
 Push Type Retainers
 G.M. # 11609417
 50 Pcs.

10371PK

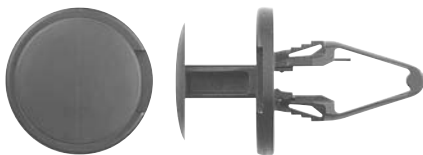

21/64" (8.5mm) Hole Size
 Panel Range: 2mm - 4.5mm
 Flange: 20mm Stem: 20.5mm
 Black Nylon
 Push Type Retainers
 G.M. # 11589292
 25 Pcs.

10374PK

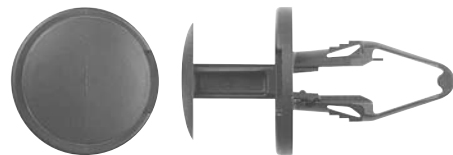

21/64" (8.5mm) Hole Size
 Panel Range: 4.5mm - 7mm
 Flange: 20mm Stem: 22mm
 Black Nylon
 Push Type Retainers
 G.M. # 11589293
 25 Pcs.

10372PK



21/64" (8.5mm) Hole Size
 Panel Range: 7mm - 10mm
 Flange: 20mm Stem: 24mm
 Black Nylon
 Push Type Retainers
 G.M. # 11589294
 25 Pcs.

10542PK



21/64" (8.5mm) Hole Size
 Flange: 34mm Shoulder: 3.5mm
 Stem Length: 17mm
 Black & White Nylon With Sealer
 Bumper Retainers
 Chrysler # 4806334-AA
 10 Pcs.

10499PK

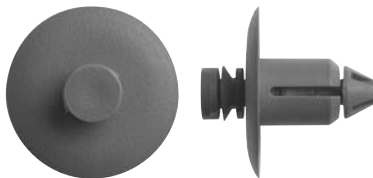

23/64" (9mm) Hole Size
 Flange Diameter: 22mm
 Stem Length: 10mm
 Tan Nylon
 Door Trim Panel Retainers
 Chrysler # OWX68BD1-AA
 25 Pcs.

10516PK

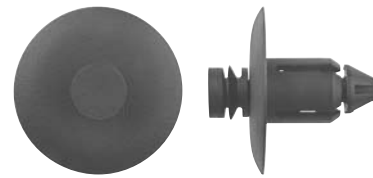

23/64" (9mm) Hole Size
 Flange Diameter: 22mm
 Stem Length: 10mm
 Black Nylon
 Door Trim Panel Retainers
 Chrysler # WX68DX9-AA
 25 Pcs.

9943PK



23/64" (9mm) Hole Size
 Flange: 18mm Stem: 13mm
 Black Nylon
 Fender & Bumper
 Push Type Retainers
 Mitsubishi # MR200300
 15 Pcs.

10247PK

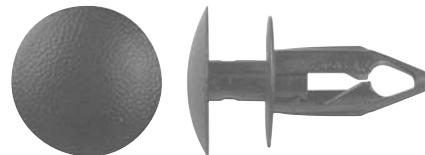

23/64" (9mm) Hole Size
 Flange: 20mm Stem: 21mm
 Black Nylon
 Rear Bumper Cover
 Push Type Retainers
 G.M. # 15153415
 25 Pcs.

4

10356PK

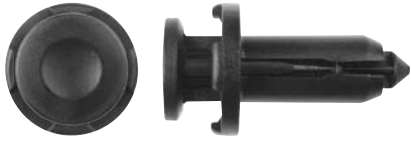

23/64" (9mm) Hole Size
 Flange: 18mm Stem: 31mm
 Black Nylon
 Bumper Cover & Grille
 Push Type Retainers
 Nissan # 63848-9E001
 10 Pcs.

9327PK



11/32" (9mm) Hole Size
 Flange: 18mm Stem: 28mm
 Black Nylon
 Rear Bumper Cover
 Push Type Retainers
 Toyota # 52161-16010
 4 Pcs.

10628PK



23/64" (9mm) Hole Size
 Flange: 18mm Stem: 31mm
 Black Nylon
 Bumper Cover & Grille
 Push Type Retainers
 Toyota # 52161-20010
 15 Pcs.

10824PK

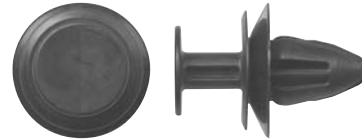

3/8" (9.5mm) Hole Size
 Top Head Diameter: 12mm
 Stem Length: 13mm
 Black Nylon
 Trim Panel Retainers
 Acura # 90602-SEP-A00
 15 Pcs.

10375PK

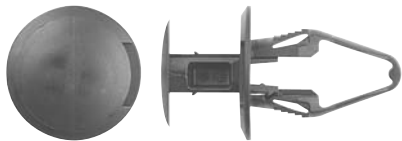

3/8" (9.5mm) Hole Size
 Panel Range: 2.95mm - 5.75mm
 Flange: 18mm Stem: 20mm
 Black Nylon
 Push Type Retainers
 G.M. # 11561368
 25 Pcs.

10674PK

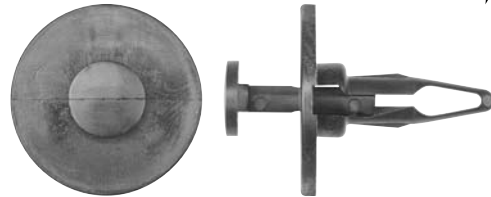

3/8" (9.5mm) Hole Size
 Flange: 1" Shoulder: 5/32"
 Stem Length: 15/16"
 Black Nylon
 Rear Bumper Fascia Retainers
 G.M. # 22587036
 25 Pcs.

9370PK



3/8" (9.5mm) Hole Size
 Flange Diameter: 18mm
 Stem Length: 23mm
 Black Nylon
 Front Bumper Fascia Retainers
 G.M. # 10157900
 25 Pcs.

10666PK



3/8" (9.5mm) Hole Size
 Flange Diameter: 21mm
 Stem Length: 23mm
 Black Nylon
 Tail Light Housing Retainers
 Chrysler # 4857345-AA
 25 Pcs.

5677PK



3/8" (9.5mm) Hole Size
 Flange Diameter: 1"
 Stem Length: 11/16"
 Black Nylon
 Fascia Retainers
 G.M. # 14045480
 25 Pcs.

10522PK

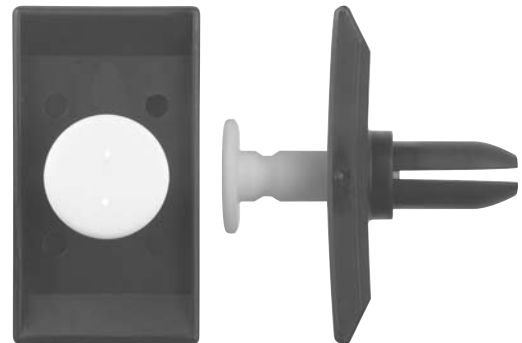

3/8" (9.5mm) Hole Size
 Flange: 25mm x 45mm Shold: 3mm Stem: 20.5mm
 Black & Natural Nylon Bumper Cover Retainers
 Chrysler # 55157112-AA
 15 Pcs.

10681PK



25/64" (10mm) Hole Size
 Flange Diameter: 20mm
 Stem Length: 13mm
 Black Nylon With Metal Insert
 Front Bumper Retainers
 Honda # 91505-S9A-003
 10 Pcs.

10625PK



25/64" (10mm) Hole Size
 Flange Diameter: 20mm
 Stem Length: 14mm
 Black Nylon
 Grille Mounting Retainers
 Honda # 91503-S0K-A01
 15 Pcs.

9294PK



25/64" (10mm) Hole Size
 Flange Diameter: 18mm
 Stem Length: 15mm
 Black Nylon
 Push Type Retainers
 Nissan # 01553-09241
 15 Pcs.

9282PK



25/64" (10mm) Hole Size
 Flange: 20mm Stem: 16mm
 Black Nylon
 Front Bumper
 Push Type Retainers
 Acura # 91503-SZ3-003
 15 Pcs.

10955PK



25/64" (10mm) Hole Size
 Flange Diameter: 20mm
 Stem Length: 16mm
 Black Nylon With Metal Insert
 Bumper Retainers
 Honda # 91506-S9A-003
 10 Pcs.

9382PK



25/64" (10mm) Hole Size
 Flange: 20mm Stem: 18mm
 Black Nylon
 Front & Rear Bumper
 Push Type Retainers
 Honda # 91503-SZ5-003
 15 Pcs.

5678PK



25/64" (10mm) Hole Size
 Flange Diameter: 16mm
 Stem Length: 12.5mm
 Natural Nylon
 Push Type Retainers
 Ford # XL3Z17E971-AA
 25 Pcs.

10518PK



25/64" (10mm) Hole Size
 Flange Diameter: 20mm
 Stem Length: 16mm
 Black Nylon
 Radiator Grille Retainers
 Chrysler # 6507669-AA
 25 Pcs.

10500PK



25/64" (10mm) Hole Size
 Flange Diameter: 18mm
 Stem Length: 26mm
 Black Nylon
 Door Trim Panel Retainers
 G.M. # 11588988
 25 Pcs.

10502PK



25/64" (10mm) Hole Size
 Flange Diameter: 18mm
 Stem Length: 26mm
 Black Nylon
 Bumper Cover Retainers
 G.M. # 11519444
 25 Pcs.

2026PK



25/64" (10mm) Hole Size
 Panel Range: 20mm
 Flange: 20mm Stem: 21mm
 Black Nylon
 Front Bumper Fascia Retainers
 G.M. # 10108746
 25 Pcs.

10377PK

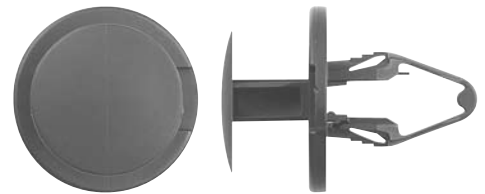

25/64" (10mm) Hole Size
 Panel Range: 3mm - 6mm
 Flange: 25mm Stem: 20mm
 Black Nylon
 Push Type Retainers
 G.M. # 11589295
 15 Pcs.

10378PK

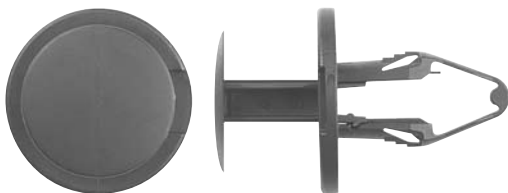

13/32" (10.5mm) Hole Size
 Panel Range: 6mm - 9mm
 Flange: 25mm Stem: 22.5mm
 Black Nylon
 Push Type Retainers
 G.M. # 11589296
 15 Pcs.

10519PK

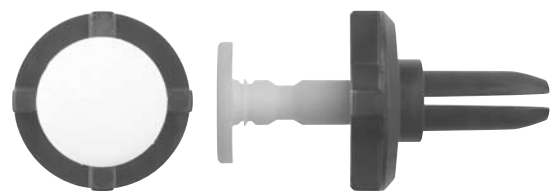

17/16" (11mm) Hole Size
 Flange: 24mm Shoulder: 4mm
 Stem Length: 20mm
 Black Nylon
 Front Bumper Retainers
 Chrysler # 4806110-AA
 15 Pcs.

9592PK



17/16" (11mm) Hole Size
 Flange Diameter: 1 3/16"
 Stem Length: 2"
 Black Nylon
 Fascia Push Type Retainers
 G.M. # 214077131
 10 Pcs.

10714PK

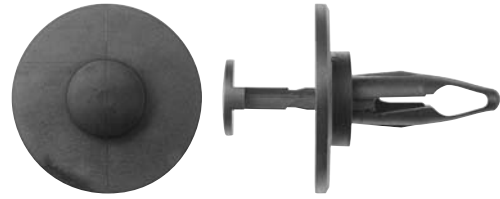

1/2" (12.7mm) Hole Size
 Flange: 1" Shoulder: 7/64"
 Stem Length: 15/16"
 Black Nylon
 Plastic Cover On Engine Ret.
 G.M. # 14101262
 25 Pcs.

1447PK

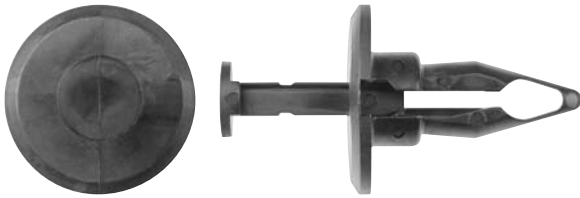

1/2" (12.7mm) Hole Size
 Flange: 1" Shoulder: 1/4"
 Stem Length: 1 1/8"
 Black Nylon
 Bumper Fascia Retainers
 G.M. # 10077283
 25 Pcs.

1448PK



1/2" (12.7mm) Hole Size
 Flange: 7/8" Shoulder: 3/16"
 Stem Length: 1 3/64"
 Black Nylon
 Bumper Fascia Retainers
 G.M. # 14103461
 25 Pcs.

5672PK



1/2" (12.7mm) Hole Size
 Flange: 1" Shoulder: 1/8"
 Stem Length: 3/4"
 Black Nylon
 Bumper Pad Blind Rivets
 G.M. # 5973400
 25 Pcs.

1234PK



1/2" (12.7mm) Hole Size
 Flange: 7/8" Shoulder: 5/32"
 Stem Length: 25/32"
 Blue Nylon
 Fascia Retainers
 G.M. # 5973823
 25 Pcs.

5680PK



1/2" (12.7mm) Hole Size
 Flange: 1" Shoulder: 3mm
 Stem Length: 1"
 Black Nylon
 Bumper Fascia Blind Rivets
 G.M. # 22535007
 25 Pcs.

2050PK

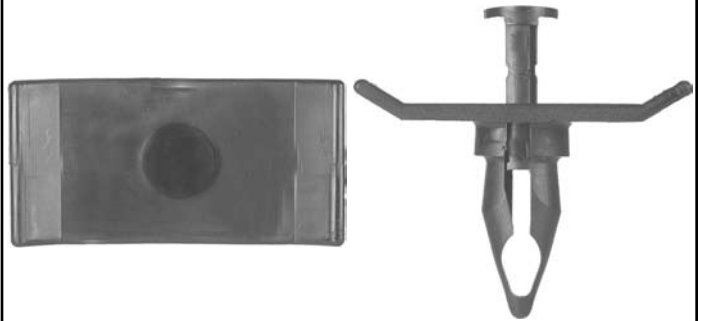

1/2" (12.7mm) Hole Size
 Flange: 7/8" x 1 25/32"
 Shoulder: 3/16" Stem: 1 1/16"
 Black Nylon
 Rear Fascia Retainers
 Chrysler # 4630253
 15 Pcs.

10382PK

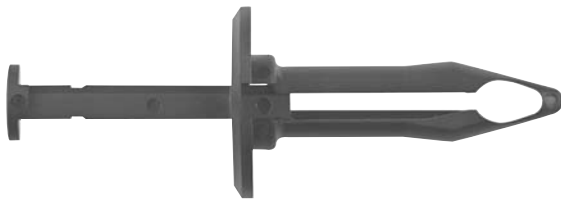

1/2" (12.7mm) Hole Size
 Flange: 1" Shoulder: 9/64"
 Stem Length: 1 5/8"
 Black Nylon Front
 License Plate Retainers
 G.M. # 15959832
 5 Pcs.

10535PK



19/32" (15mm) Hole Size
 Flange: 22mm Stem: 13mm
 Black Nylon
 Rocker Moulding
 Push Type Retainers
 G.M. # 5480772
 10 Pcs.

10686PK



13/64" (5mm) Hole Size
 Flange Diameter: 10mm
 Stem Length: 12mm
 Black Nylon
 Front Fascia Retainers
 Toyota # 90467-05090
 25 Pcs.

9108PK

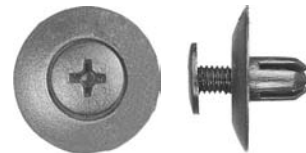

15/64" (6mm) Hole Size
 Flange Diameter: 20mm
 Stem Length: 9mm
 Black Nylon
 Push Type Retainers
 Mazda # 1395-68-676
 15 Pcs.

4

10615PK



15/64" (6mm) Hole Size
 Flange Diameter: 14mm
 Stem Length: 9mm
 Black Nylon
 Belt Moulding Push Type Retainers
 Nissan # 01553-01733
 15 Pcs.

1999PK

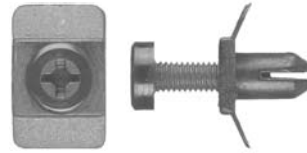

15/64" (6mm) Hole Size
 Flange Dia.: 12mm x 18mm
 Stem Length: 10mm
 Black Nylon
 Push Type Retainers
 Nissan # 66824-W1000
 15 Pcs.

1597PK



15/64" (6mm) Hole Size
 Flange Diameter: 15mm
 Stem Length: 11mm
 Black Nylon
 Push Type Retainers
 Honda # 90684-SA5-0030
 25 Pcs.

5930PK



1/4" (6mm) Hole Size
 Flange Diameter: 18mm
 Stem Length: 11mm
 Black Nylon
 Vent Panel Blind Rivets
 Honda # 90688-SB0-003
 25 Pcs.

2028PK

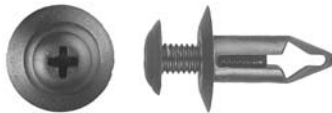

15/64" (6mm) Hole Size
 Flange: 14mm Stem: 16mm
 Black Nylon
 Cowl Panel to Reinf. Plate &
 Engine Splash Shield Retainers
 Nissan # 66860-01W01
 25 Pcs.

9783PK



15/64" (6mm) Hole Size
 Flange Diameter: 11mm
 Stem Length: 20mm
 Black Nylon
 Rocker Panel Retainers
 G.M. # 10246149
 25 Pcs.

10468PK



1/4" (6.3mm) Hole Size
 Flange Diameter: 11/16"
 Stem Length: 3/4"
 Black Nylon
 Trim Panel Retainers
 Ford # N807578-S
 15 Pcs.

9968PK



1/4" (6.3mm) Hole Size
 Flange Diameter: 5/8"
 Stem Length: 29/32"
 Black Nylon
 Exterior Blind Rivets
 Ford # N803946S
 50 Pcs.

9067PK



1/4" (6.3mm) Hole Size
 Flange Diameter: 11/16"
 Stem Length: 29/32"
 Black Nylon
 Radiator Shroud Blind Rivets
 Ford # N804570S
 25 Pcs.

1399PK



1/4" (6.3mm) Square Hole
 Flange Dia.: 15/32" x 15/32"
 Flange Diameter: 21/32"
 Black Nylon
 Trim & Grille Fascia Retainers
 Ford # N803494S
 25 Pcs.

9509PK

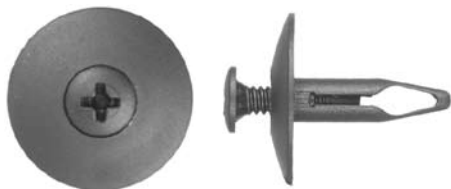

1/4" (6.3mm) Hole Size
 Flange Diameter: 1"
 Stem Length: 7/8"
 Black Nylon
 Interior Trim Retainers
 Ford # N-804837-S
 50 Pcs.

10716PK



17/64" (7mm) Hole Size
 Flange Diameter: 20mm
 Stem Length: 8mm
 Black Nylon
 Garnish Moulding Retainers
 G.M. # 88970494
 15 Pcs.

4

2015PK



17/64" (7mm) Hole Size
 Flange Diameter: 14mm
 Stem Length: 11mm
 Black Nylon
 Push Type Retainers
 Honda # 90657-SA6-0030
 25 Pcs.

2155PK



17/64" (7mm) Square Hole Size
 Flange Diameter: 15mm
 Stem Length: 13mm
 Black Nylon
 Push Type Retainers
 Honda # 91550-SH3-003
 25 Pcs.

10413PK



17/64" (7mm) Hole Size
 Flange: 20mm Stem: 9mm
 Black Nylon
 Quarter Panel
 Moulding Retainers
 Toyota # 90467-07044
 10 Pcs.

2143PK



17/64" (7mm) Hole Size
 Flange Diameter: 20mm
 Stem Length: 12mm
 Black Nylon
 Push Type Retainers
 Lexus # 90467-07138
 10 Pcs.

1603PK



17/64" (7mm) Hole Size
 Flange Diameter: 15mm
 Stem Length: 12mm
 Black Nylon
 Push Type Retainers
 Toyota # 90467-06017
 15 Pcs.

10614PK



17/64" (7mm) Hole Size
 Flange Diameter: 14mm
 Stem Length: 23mm
 Black Nylon
 Push Type Retainers
 G.M. # 15014352
 15 Pcs.

5920PK



5/16" (8mm) Hole Size
 Flange Diameter: 20mm
 Stem Length: 9mm
 Black Nylon
 Splash Shield Blind Rivets
 Honda # 90675-SB3-003
 25 Pcs.

10538PK

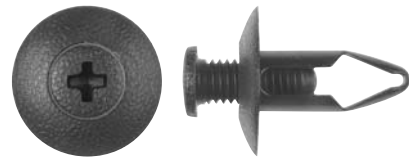

5/16" (8mm) Hole Size
 Flange Diameter: 20mm
 Stem Length: 20mm
 Black Nylon
 Front Bumper Fascia Retainers
 Nissan # 63854-01A00
 15 Pcs.

1446PK



5/16" (8mm) Hole Size
 Flange Diameter: 19/32"
 Stem Length: 13/16"
 Black Nylon
 Push Type Retainers
 G.M. # 10053182
 25 Pcs.

10523PK

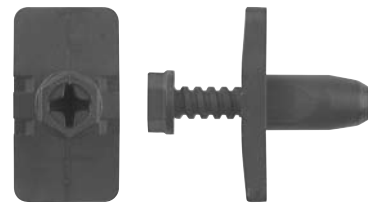

5/16" (8mm) Hole Size
 Flange Dia.: 14mm x 26mm
 Stem Length: 14mm
 Black Nylon
 Front Bumper Retainers
 G.M. # 12337831
 50 Pcs.

1265PK



5/16" (8mm) Hole Size
 Flange Diameter: 17mm
 Stem Length: 18mm
 Black Nylon
 Push Type Retainers
 G.M. # 20451119
 25 Pcs.

1973PK



5/16" (8mm) Hole Size
 Flange Diameter: 18mm
 Stem Length: 21mm
 Black Nylon
 Push Type Retainers
 Honda # 90505-SM4-003
 10 Pcs.

5901PK



5/16" (8mm) Hole Size
Flange Diameter: 20mm
Stem Length: 18mm
Black Nylon
Inter Fender Shield Blind Rivets
Nissan # 63844-01A00
25 Pcs.

1976PK



5/16" (8mm) Hole Size
Flange: 20mm Stem: 9mm
Black Nylon
Fender Splash Shield
Push Type Retainers
Honda # 91512-SM4-003
10 Pcs.

10747PK



5/16" (8mm) Hole Size
Flange Diameter: 20mm
Stem Length: 9mm
Black Nylon
Mud Guard Push Type Retainers
Mazda # BC1D-56-145
15 Pcs.

9287PK



5/16" (8mm) Hole Size
Flange Diameter: 18mm
Stem Length: 12mm
Black Nylon
Push Type Retainers
Ford # MB-455-56143
10 Pcs.

1972PK



5/16" (8mm) Hole Size
Flange Diameter: 20mm
Stem Length: 15mm
Hex Phillips Drive Splash Shield
Push Type Retainers
Honda # 91516-SK7-013
10 Pcs.

10914PK



5/16" (8mm) Hole Size
Flange Diameter: 13mm
Stem Length: 18mm
Black Nylon
Bumper Push Type Retainers
Ford # W713445-S300
15 Pcs.

2163PK

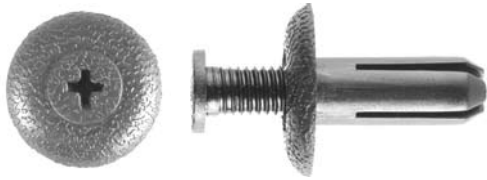

5/16" (8mm) Hole Size
 Flange Diameter: 20 mm
 Stem Length: 21mm
 Black Nylon
 Push Type Retainers
 Acura # 90505-SL0-003
 5 Pcs.

10624PK



23/64" (9mm) Hole Size
 Flange Diameter: 20mm
 Stem Length: 9mm
 Black Nylon
 Push Type Retainers
 Toyota # 90467-09166
 15 Pcs.

2027PK



23/64" (9mm) Hole Size
 Flange: 15mm Stem: 16mm
 Black Nylon
 Bumper Cover
 Push Type Retainers
 Toyota # 90467-09145
 15 Pcs.

1943PK

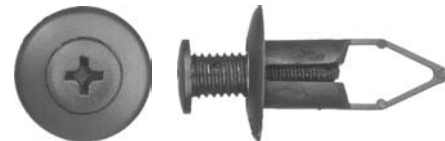

23/64" (9mm) Hole Size
 Flange: 18mm Stem: 23mm
 Black Nylon
 Bumper Cover
 Push Type Retainers
 Lexus # 90467-09101
 25 Pcs.

5895PK



23/64" (9mm) Hole Size
 Flange Diameter: 15mm
 Stem Length: 27mm
 Black Nylon
 Bumper Cover Blind Rivets
 Lexus # 90467-09093
 10 Pcs.

9202PK



25/64" (10mm) Hole Size
 Flange Diameter: 20mm
 Stem Length: 15mm
 Black Nylon
 Push Type Retainers
 Acura # 91503-SP0-0030
 15 Pcs.

1998PK

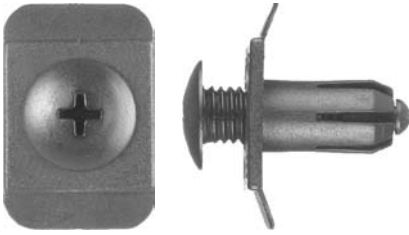

25/64" (10mm) Hole Size
 Flange Dia.: 20mm x 30mm
 Stem Length: 18mm
 Black Nylon
 Bumper Cover Retainers
 Nissan # 01553-01393
 10 Pcs.

D-124PK

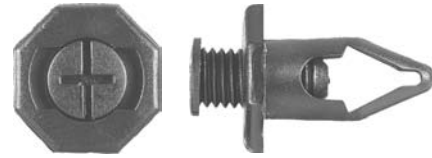

25/64" (10mm) Hole Size
 Flange Diameter: 20mm
 Stem Length: 24mm
 Black Nylon
 Bumper Fascia Retainers
 Honda # 91504-SM4-0000
 10 Pcs.

2060PK



25/64" (10mm) Hole Size
 Flange Diameter: 20mm
 Stem Length: 25mm
 Black Nylon
 Bumper Retainers
 Honda # 91502-SP0-003
 10 Pcs.

D-123PK



25/64" (10mm) Hole Size
 Flange Diameter: 20mm
 Stem Length: 27mm
 Black Nylon
 Bumper Fascia Retainers
 Honda # 91502-SM4-0000
 10 Pcs.

2153PK



7/16" (11mm) Hole size
 Flange: 22mm Shoulder: 3.5mm
 Stem Length: 14mm
 Black Nylon
 Bumper & Fascia Retainers
 Nissan # 01553-03101
 15 Pcs.

1730PK

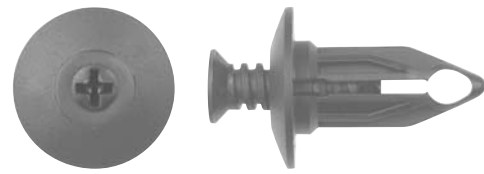

31/64" (12mm) Hole Size
 Flange: 21mm Shoulder: 3mm
 Stem Length: 25mm
 Black Nylon
 Rear Bumper Fascia Retainers
 G.M. # 10140480
 25 Pcs.

2077PK



1/4-20" by 1/4" Hole Size
 Flange Diameter: 9/16"
 Over All Length: 1"
 Black Nylon
 Cowl Screen Retainers
 (Use with # 2076)
 Chrysler # 6503336
 25 Pcs.

2076PK

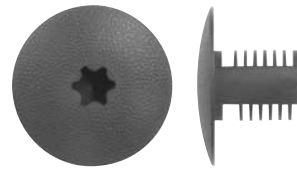

Flange: 13/16" Stem: 15/32"
 Black Nylon
 Cowl Top Stud
 Retainer Cover
 (Use with # 2077)
 Chrysler # 6503339
 25 Pcs.

10678PK



Stem Diameter: 4.1mm
 Stem Length: 15mm
 Black Nylon
 Cowl Screen Pin Retainers
 Use with # 10618
 Nissan # 66820-88E00
 25 Pcs.

10618PK



Head Dia.: 13mm x 13mm
 Stem Length: 13mm
 White Nylon With Sealer
 Cowl Vent Grommets
 Use with # 10678
 Nissan # 80874-0P00
 15 Pcs.

10621PK



4mm Hole Size
 Top Head Diameter: 13mm
 Stem Length: 13mm
 White Nylon
 Cowl Vent Retainers
 Nissan # 66820-3S500-C1
 25 Pcs.

9694PK

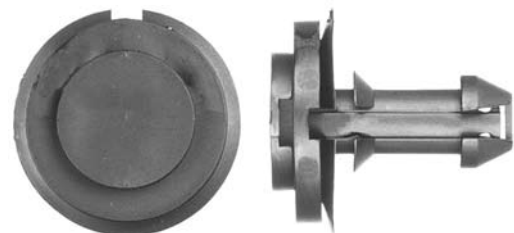

Flange Diameter: 30mm
 Stem Length: 24mm
 Black Nylon
 Front Air Deflector Retainers
 (Use With # 9695)
 G.M. # 15733971
 15 Pcs.

9695PK

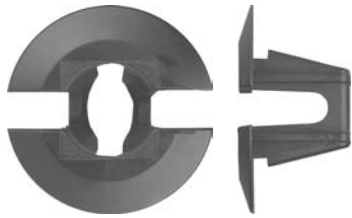

Flange Diameter: 28mm
Stem Length: 13mm
Black Nylon
Front Air Deflector Grommets
(Use With # 9694)
G.M. # 15733970
25 Pcs.

10540PK

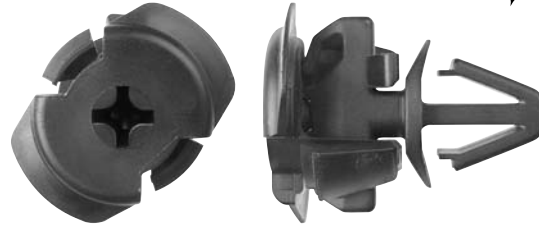

13mm x 9mm Hole Size
Flange Dia.: 19mm x 30mm
Stem Length: 15mm
Black & Gray Nylon
Radiator Grille Retainers
G.M. # 15764320
10 Pcs.

4

Windshield Fasteners



5

816PK



Rear Window
Reveal Moulding Clips
G.M. # 4533699
100 Pcs.

9548PK



Windshield & Rear
Window
Reveal Moulding Clips
G.M. # 20603072
100 Pcs.

2065PK



Windshield & Rear
Window
Reveal Moulding Clips
G.M. # 9808241
50 Pcs.

9898PK



Windshield Upper & Lower
Reveal Moulding Clips
G.M. # 7698976
100 Pcs.

825PK



Rear Window
Reveal Moulding Clips
G.M. # 8717859
100 Pcs.

9899PK



Windshield
Reveal Moulding Clips
G.M. # 9895598
50 Pcs.

817PK



Windshield, Skylight
Quarter & Rear Windshield
Reveal Moulding Clips
G.M. # 7730788
50 Pcs.

9546PK



Windshield & Rear Window
Reveal Moulding Clips
G.M. # 7693140
50 Pcs.

986PK



White Nylon
Windshield & Rear Window
Reveal Moulding Clips
G.M. # 1654047
100 Pcs.

985PK



White Nylon
Windshield to Panel
Reveal Moulding Clips
G.M. # 9731301
100 Pcs.

1371PK



Windshield & Backlite
Reveal Moulding Clips
Ford # E3SB6342413AB
50 Pcs.

9874PK



Rear Window
Reveal Moulding Clips
Ford # C6AB-6242413-A
100 Pcs.

5

9550PK



Windshield & Rear Window
Reveal Moulding Clips
Ford # C5ZZ-6543413-B
100 Pcs.

9545PK



Windshield & Rear Window
Reveal Moulding Clips
Ford # C8AZ-63642413-A
100 Pcs.

9504PK



Windshield & Backlite
Reveal Moulding Clips
Chrysler # 6003752
50 Pcs.

9547PK



9/32" (7mm) Square Hole Size
7/64" (3mm) I.D. Hose
13/64" (5mm) O.D. Hose
Natural Nylon
Windshield Washer Hose Retainers
Honda # 90652-SB2-023
15 Pcs.

1994PK



Gray Nylon
Windshield Washer
Hose Clips
Honda # 91512-SE0-003
15 Pcs.

10727PK

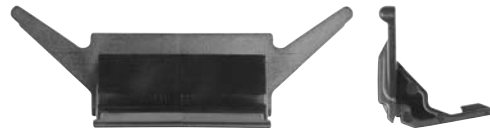

22mm Wide
46mm Length
Black Nylon
Windshield Moulding Clips
Nissan
25 Pcs.

Door Fasteners



812PK



Bright Zinc Finish
Door Window
Crank Handle
Retaining Clips
100 Pcs.

9507PK

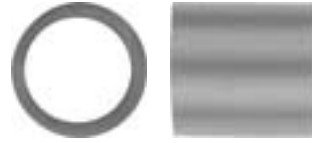

9/16" I.D.
11/16" O.D.
3/4" Long
PVC Plastic
Door Lock Stricker Bushings
25 Pcs.

9731PK



5/32" Rod Size
Hole Size: 6mm
Orange Nylon
Door Lock Rod Clips
G.M. # 16606936
100 Pcs.

9437PK



5/32" Rod Size
Hole Size: 15/64"
Left Hand Side
Black Nylon
Door Lock Rod Clips
G.M. # 20582532
25 Pcs.

9438PK



5/32" Rod Size
Hole Size: 15/64"
Right Hand Side
Natural Nylon
Door Lock Rod Clips
G.M. # 20582533
25 Pcs.

9987PK

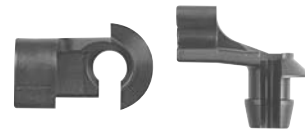

5/32" Rod Size
Hole Size: 15/64"
Left Hand Side
Black Nylon
Door Lock Rod Clips
Chrysler # 4717165
25 Pcs.

6

9986PK

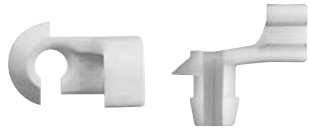

5/32" Rod Size
Hole Size: 15/64"
Right Hand Side
Natural Nylon
Door Lock Rod Clips
Chrysler # 4717164
25 Pcs.

9960PK



5/32" Rod Size
Hole Size: 15/64"
Left Hand Side
Black Nylon
Door Lock Rod Clips
G.M. # 16630689
25 Pcs.

9959PK

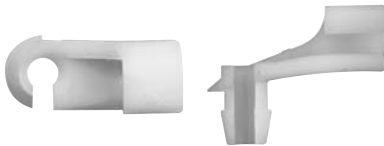

5/32" Rod Size
Hole Size: 15/64"
Right Hand Side
Natural Nylon
Door Lock Rod Clips
G.M. # 16630688
25 Pcs.

9981PK

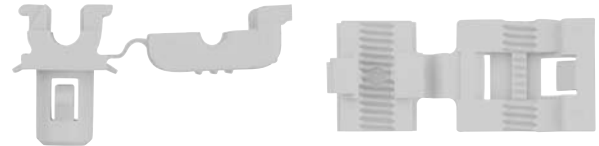

10-24 Rod Size
Panel Range: 2mm
Hole Size: 8mm
Yellow Nylon
Door Lock & Tailgate Rod Clips
G.M. # 16629990
15 Pcs.

10083PK



Fits a Oblong Hole
Right & Left Side
Black Nylon
Door Rod End Clips
G.M. # 15685073
25 Pcs.

10082PK



5/16" Rod Size
Natural Nylon
Hood Prop Rod Clips
G.M. # 21097292
15 Pcs.

10084PK

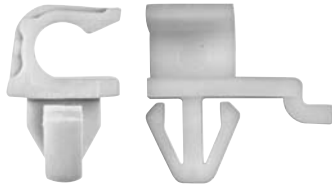

7mm Rod Size
Hole Size: 10mm
Natural Nylon
Hood Prop Rod Clips
G.M. # 15021761
10 Pcs.

1083PK



Door Lock
Rod End Clips
G.M. # 4234830
25 Pcs.

9726PK

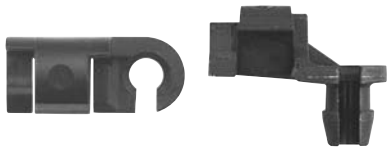

5/32" Rod Size
Hole Size: 17/64"
Left Hand Side
Black Nylon
Door Rod & Hood Clips
Ford # N804344S
50 Pcs.

9725PK



5/32" Rod Size
Hole Size: 17/64"
Right Hand Side
Natural Nylon
Door Rod & Hood Clips
Ford # N805350S
20 Pcs.

9728PK

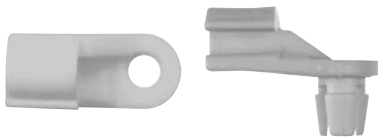

5/32" Rod Size
Hole Size: 17/64"
Left Hand Side
Yellow Nylon
Door Lock Rod Clips
Ford # E6AZ-5421952-A
25 Pcs.

10078PK



#10-24 Rod Size
Hole Size: 8mm
White Nylon
Fold Over Type
Door Lock Rod Clips
Ford # E6AZ-5421952-A
10 Pcs.

6

10080PK



#10-24 Rod Size
Folder Over Type
Yellow Nylon
Door Lock Rod Clips
Ford # F85Z-152195-BB
10 Pcs.

9729PK

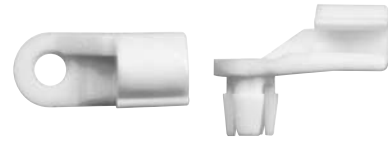

5/32" Rod Size
Hole Size: 17/64"
Right Hand Side
Natural Nylon
Door Lock Rod Clips
Ford # 3990522S
25 Pcs.

10079PK

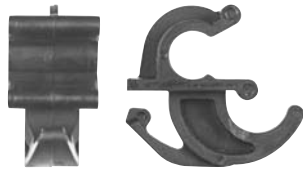

1/4" Rod Size
Black Nylon
Hood Prop Rod Clips
Ford # E1FZ16828-C
25 Pcs.

10081PK

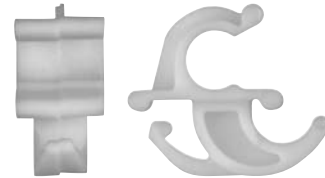

5/16" Rod Size
Natural Nylon
Hood Prop Rod Clips
Ford # E83Z-16828A
10 Pcs.

10076PK



5/16" Rod Size
Natural Nylon
Hood Prop Rod Clips
Ford # 386299-S
25 Pcs.

10077PK

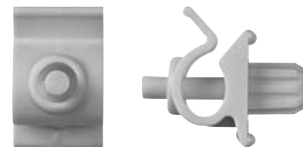

6mm Rod Size
Square Hole Size: 7mm
Yellow Nylon
Hood Prop Rod Clips
Ford # W702380-S300
5 Pcs.

9963PK



5/32" Rod Size
Hole Size: 15/64"
Left Hand Side
Green Nylon
Door Lock Rod Clips
Chrysler # 4658675
25 Pcs.

9962PK

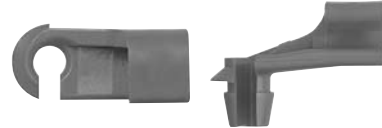

5/32" Rod Size
Hole Size: 15/64"
Right Hand Side
Red Nylon
Door Lock Rod Clips
Chrysler # 4658674
25 Pcs.

1250PK



5/32" Rod Size
Hole Size: 15/64"
Left Hand Side
Green Nylon
Door Lock Rod Clips
Chrysler # 3454221
50 Pcs.

1249PK



5/32" Rod Size
Hole Size: 15/64"
Right Hand Side
Red Nylon
Door Lock Rod Clips
Chrysler # 3454220
50 Pcs.

9384PK

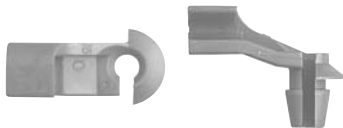

1/8" Rod Size
Hole Size: 13/64"
Left Hand Side
Orange Nylon
Door Lock Rod Clips
Chrysler # 4658445
25 Pcs.

9961PK

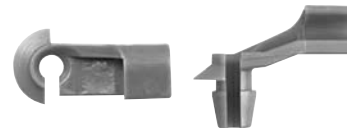

1/8" Rod Size
Hole Size: 13/64"
Right Hand Side
Purple Nylon
Door Lock Rod Clips
Chrysler # 4658444
25 Pcs.

6

9988PK



5/16" Rod Size
1 3/8" O.A. Length
Black Nylon
Hood Prop Rod Clips
Chrysler # J4007456
10 Pcs.

10229PK

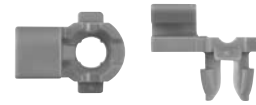

3.4mm Rod Size
Hole Size: 6mm
Left Hand Side
Purple Nylon
Door Rod End Clips
Honda # 72151-S5P-A00
25 Pcs.

10230PK



3.4mm Rod Size
Hole Size: 6mm
Right Hand Side
Yellow Nylon
Door Rod End Clips
Honda # 72111-S5P-A00
25 Pcs.

10225PK



3.5mm Rod Size
Hole Size: 5mm
Left Hand Side
Black Nylon
Door Rod End Clips
Honda # 72113-SR4-004
25 Pcs.

10226PK



3.5mm Rod Size
Hole Size: 5mm
Right Hand Side
Brown Nylon
Door Rod End Clips
Honda # 72112-SR4-004
25 Pcs.

10121PK



3.5mm Rod Size
Hole Size: 6mm
Left Hand Side
Brown Nylon
Door Rod End Clips
Honda # 72674-SM4-003
25 Pcs.

10122PK



3.5mm Rod Size
Hole Size: 6mm
Right Hand Side
Blue Nylon
Door Rod End Clips
Honda # 72634-SM4-003
25 Pcs.

10227PK

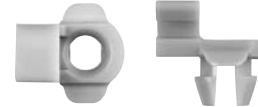

3.5mm Rod Size
Hole Size: 6mm
Left Hand Side
Natural Nylon
Door Rod End Clips
Honda # 72139-SR0-A01
25 Pcs.

10228PK



3.5mm Rod Size
Hole Size: 6mm
Right Hand Side
Purple Nylon
Door Rod End Clips
Honda # 72616-SM4-003
25 Pcs.

10235PK



3.5mm Rod Size
Hole Size: 6mm
Left Hand Side
Brown Nylon
Door Rod End Clips
Honda # 06720-SJC-305(L)
25 Pcs.

10236PK



3.5mm Rod Size
Hole Size: 6mm
Right Hand Side
Blue Nylon
Door Rod End Clips
Honda # 06720-SJC-305(R)
25 Pcs.

10237PK



3.6mm Rod Size
Hole Size: 6mm
Left Hand Side
Black Nylon
Door Rod End Clips
Honda # 72174-S2X-003
25 Pcs.

6

10238PK



3.6mm Rod Size
 Hole Size: 6mm
 Right Hand Side
 Natural Nylon
 Door Rod End Clips
 Honda # 72134-S2X-003
 25 Pcs.

10233PK



3.9mm Rod Size
 Hole Size: 7mm
 Left Hand Side
 Blue Nylon
 Door Rod End Clips
 Honda # 72139-SW5-003
 25 Pcs.

10234PK



3.9mm Rod Size
 Hole Size: 7mm
 Right Hand Side
 Pink Nylon
 Door Rod End Clips
 Honda # 72111-S9V-A00
 25 Pcs.

10231PK



4mm Rod Size
 Hole Size: 6mm
 Left Hand Side
 Yellow Nylon
 Door Rod End Clips
 Honda # 72174-SM4-003
 25 Pcs.

10232PK



4mm Rod Size
 Hole Size: 6mm
 Right Hand Side
 Purple Nylon
 Door Rod End Clips
 Honda # 72134-SM4-003
 25 Pcs.

10216PK



4.2mm Rod Size
 Hole Size: 6mm
 Left Hand Side
 Purple Nylon
 Door Rod End Clips
 Honda # 72116-SM4-003
 25 Pcs.

10217PK



4.2mm Rod Size
Hole Size: 6mm
Right Hand Side
Orange Nylon
Door Rod End Clips
Honda # 72116-SV4-003
25 Pcs.

10114PK

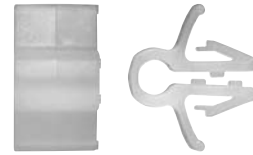

6mm Rod Size
Hole Size: 7mm
Universal
Natural Nylon
Door Rod Clips
Honda # 91591-S56-013
15 Pcs.

10223PK



4.2mm Rod Size
Hole Size: 7mm
Left Hand Side
Blue Nylon
Door Rod End Clips
Mazda # 9927-80-404
25 Pcs.

10224PK



4.2mm Rod Size
Hole Size: 7mm
Right Hand Side
Black Nylon
Door Rod End Clips
Mazda # 9927-80-405
25 Pcs.

10199PK

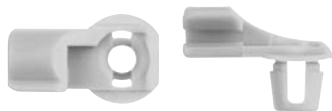

3.5mm Rod Size
Hole Size: 6.5mm
Left Hand Side
Cream Nylon
Door Rod End Clips
Nissan # 80533-AA100
25 Pcs.

10198PK



3.5mm Rod Size
Hole Size: 6.5mm
Right Hand Side
Purple Nylon
Door Rod End Clips
Nissan # 80532-AA100
25 Pcs.

6

10197PK

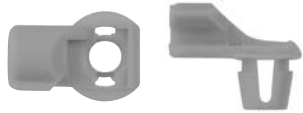

4mm Rod Size
Hole Size: 6.5mm
Left Hand Side
Blue Nylon
Door Rod End Clips
Nissan # 80532-89900
25 Pcs.

10196PK



4mm Rod Size
Hole Size: 6.5mm
Right Hand Side
Orange Nylon
Door Rod End Clips
Nissan # 80533-89900
25 Pcs.

10201PK

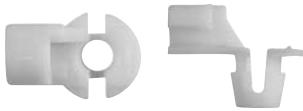

4.2mm Rod Size
Hole Size: 6.5mm
Left Hand Side
Natural Nylon
Door Rod End Clips
Nissan # 80533-01R00
25 Pcs.

10200PK



4.2mm Rod Size
Hole Size: 6.5mm
Right Hand Side
Yellow Nylon
Door Rod End Clips
Nissan # 80532-01R00
25 Pcs.

10109PK

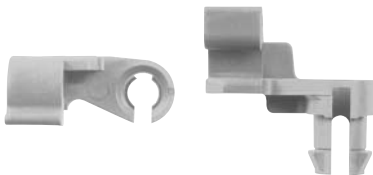

5mm Rod Size
Hole Size: 7mm
Left Hand Side
Yellow Nylon
Door Rod End Clips
Toyota # 69293-33020
10 Pcs.

10110PK



5mm Rod Size
Hole Size: 7mm
Right Hand Side
Natural Nylon
Door Rod End Clips
Toyota # 69293-33010
10 Pcs.

10117PK

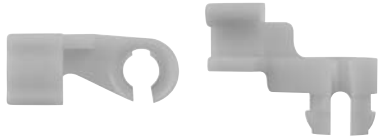

5mm Rod Size
Hole Size: 8.5mm
Left Hand Side
Yellow Nylon
Door Rod End Clips
Toyota # 72116-SV4-003
10 Pcs.

10116PK



5mm Rod Size
Hole Size: 8.5mm
Right Hand Side
Natural Nylon
Door Rod End Clips
Toyota # 72116-SM4-003
10 Pcs.

10120PK



5mm Rod Size
Hole Size: 8mm
Universal
Natural Nylon
Door Rod Clips
Toyota # 69293-30030
10 Pcs.

10203PK



8mm Rod Size
Square Hole Size: 7mm
O.A. Length: 30mm
Black Nylon
Hood Prop Rod Clips
Nissan # 65722-EA000
10 Pcs.

9183PK



8mm Hole Size
Stem Length: 11mm
Bright Zinc Finish
Door Panel Clips
V.W. # N14389-3
50 Pcs.

10700PK



15/32" Width
11/16" Height
Bright Zinc Finish
Interior Trim, Garnish,
Bezel & Scuff Plate Fasteners
G.M. # 11588650
10 Pcs.

6

9900PK



5/16" Hole Size
Bright Zinc Finish
Trim Panel Fasteners
G.M. # 4114785
50 Pcs.

9876PK



For Thin Panels
Short Leg Type
Wire Type
Trim Panel Retainers
Ford # 351050-S3
100 Pcs.

9896PK



Short Leg Type
For Thin Panels
Wire Type
Trim Panel Retainers
100 Pcs.

578PK

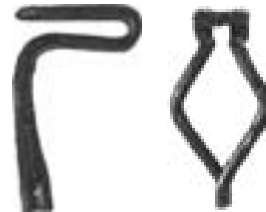

For Thin Panels
Wire Type
Trim Panel Retainers
Ford # 358470
100 Pcs.

579PK



For Medium Panels
Wire Type
Trim Panel Retainers
100 Pcs.

577PK



For Thick Panels
Wire Type
Trim Panel Retainers
Ford # 383033-S101
100 Pcs.

10090PK

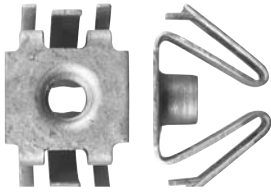

6-1.00mm Screw Size
Zinc Organic
Door Trim Panel
Retainer Nuts
G.M. # 11517769
10 Pcs.

10935PK

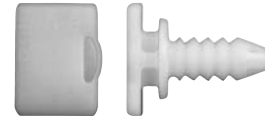

3/16" (5mm) Hole Size
Top Head Dia.: 11.5mm x 15mm
Stem Length: 14mm
White Nylon
Door Moulding Clips
V.W. # 191-853-577A
25 Pcs.

9861PK



15/64" (6mm) Hole Size
Top Head Diameter: 18mm
Stem Length: 24mm
White Nylon
Trim Panel Retainers
G.M. # 10285935
50 Pcs.

9860PK



1/4" (6.4mm) Hole Size
Top Head Diameter: 11/16"
Stem Length: 9/16"
White Nylon
Door Trim Panel Retainers
G.M. # 10287971
50 Pcs

10399PK

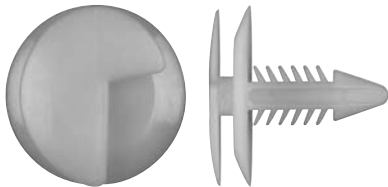

1/4" (6.3mm) Hole Size
Top Head Diameter: 15/16"
Stem Length: 3/4"
Natural Nylon
Door Trim Panel Retainers
G.M. # 20480475
50 Pcs.

1646PK



1/4" (6.5mm) Hole Size
Top Head Dia.: 6.3mm x 11.5mm
Stem Length: 21mm
Natural Nylon
Door Trim Panel Retainers
G.M. # 15545202
50 Pcs.

6

4020PK

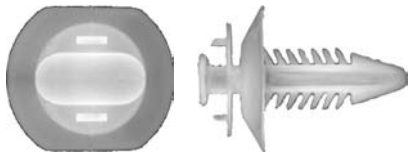

1/4" (6.5mm) Hole Size
 Top Head Dia.: 6.3mm x 11.5mm
 Stem Length: 21mm
 Natural Nylon
 Door Trim Panel Retainers
 G.M. # 20421800
 25 Pcs.

9242PK

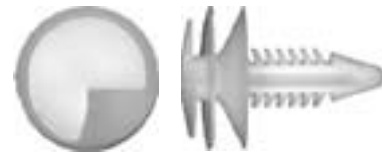

1/4" (6.5mm) Hole Size
 Top Head Diameter: 17mm
 Stem Length: 21mm
 Natural Nylon
 Door Trim Panel Retainers
 G.M. # 12337920
 50 Pcs.

5264PK

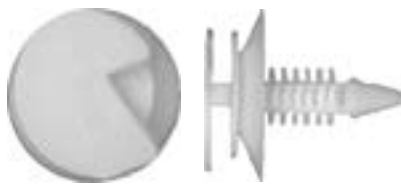

1/4" (6.5mm) Hole Size
 Top Head Diameter: 29/32"
 Stem Length: 29/32"
 Natural Nylon
 Door Trim Panel Retainers
 G.M. # 3065575
 50 Pcs.

2029PK



1/4" (6.3mm) Hole Size
 Top Head Diameter: 37/64"
 Stem Length: 11/16"
 White Nylon
 Push Type Door Trim Panel Ret.
 G.M. # 15960325
 50 Pcs.

9862PK



1/4" (6.5mm) Hole Size
 Top Head Diameter: 18mm
 Stem Length: 33mm
 White Nylon
 Door Trim Panel Retainers
 G.M. #10421018
 25 Pcs.

592PK

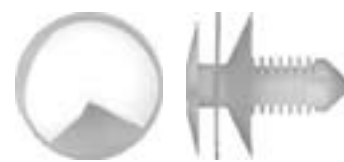

17/64" (7mm) Hole Size
 Top Head Diameter: 17.6mm
 Stem Length: 14.8mm
 Natural Nylon
 Door Trim Panel Retainers
 G.M. # 2064891
 50 Pcs.

10543PK



17/64" (7mm) Hole Size
 Top Head Diameter: 18mm
 Yellow Nylon
 Door Garnish Moulding &
 Pillar Trim Panel Retainers
 G.M. # 10408480
 25 Pcs.

2017PK



17/64" (7mm) Hole Size
 Top Head Diameter: 14mm
 Stem Length: 16mm
 Black Nylon
 Door Trim Panel Retainers
 G.M. # 15638413
 50 Pcs.

1024PK



17/64" (7mm) Hole Size
 Top Head Diameter: 20mm
 Stem Length: 18.5mm
 Natural Nylon
 Door Trim Panel Retainers
 G.M. # 9685057
 25 Pcs.

9339PK

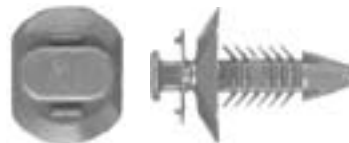

17/64" (7mm) Hole Size
 Top Head Dia.: 7mm x 12.5mm
 Stem Length: 19mm
 White Nylon
 Door Trim Panel Retainers
 G.M. # 15612948
 25 Pcs.

10403PK

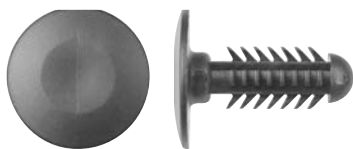

17/64" (7mm) Hole Size
 Top Head Diameter: 19mm
 Stem Length: 22mm
 Black Nylon
 Door Trim Panel Retainers
 G.M. # 25601491
 50 Pcs.

10398PK

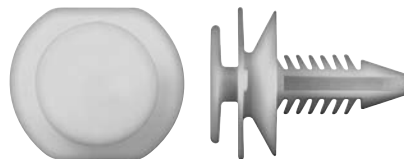

17/64" (7mm) Hole Size
 Top Head Diameter: 16mm
 Stem Length: 21mm
 Yellow Nylon
 Door Trim Panel Retainers
 G.M. # 20734005
 50 Pcs.

6

10653PK

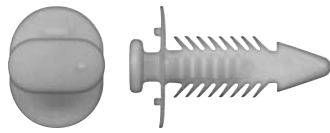

17/64" (7mm) Hole Size
 Top Head Dia.: 7mm x 12.5mm
 Stem Length: 20mm
 Natural Nylon
 Door Trim Panel Retainers
 G.M. # 15953247
 50 Pcs.

10520PK

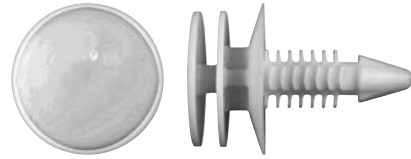

17/64" (7mm) Hole Size
 Top Head Diameter: 18mm
 Stem Length: 20.6mm
 White Nylon
 Door Panel Retainers
 G.M. # 10305191
 50 Pcs.

10495PK

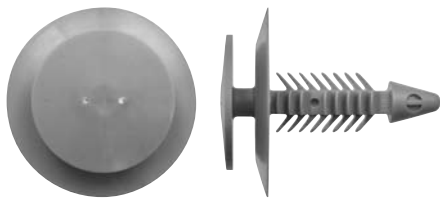

17/64" (7mm) Hole Size
 Top Head Diameter: 18mm
 Stem Length: 24mm
 Green Nylon
 Door Trim Panel Retainers
 GM # 11588863
 25 Pcs.

9224PK



17/64" (7.1mm) Hole Size
 Top Head Diameter: 13.2mm
 Stem Length: 20mm
 Natural Nylon
 Door Trim Panel Retainers
 G.M. # 21042045
 50 Pcs.

1807PK

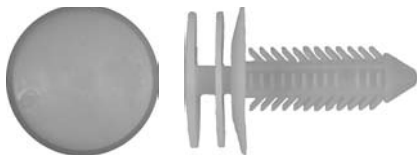

17/64" (7mm) Hole Size
 Top Head Diameter: 18mm
 Stem Length: 24mm
 White Nylon
 Door Trim Panel Retainers
 G.M. # 10153057
 25 Pcs.

1716PK

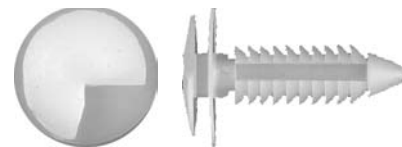

17/64" (7mm) Hole Size
 Top Head Diameter: 17mm
 Stem Length: 25mm
 Natural Nylon
 Door Trim Panel Retainers
 G.M. # 363137
 100 Pcs.

9502PK



17/64" (7mm) Hole Size
 Top Head Diameter: 22mm
 Stem Length: 27mm
 White Nylon
 Door Trim Panel Retainers
 G.M. # 20451401
 25 Pcs.

9368PK



17/64" (7mm) Hole Size
 Top Head Diameter: 20mm
 Stem Length: 32mm
 Natural Nylon
 Door Trim Panel Retainers
 G.M. # 10126901
 50 Pcs.

10544PK



17/64" (7mm) Hole Size
 Top Head Diameter: 15mm
 Stem Length: 13mm
 White Nylon
 Door Trim Panel Retainers
 Ford # W701971-S
 25 Pcs.

9373PK



17/64" (7mm) Hole Size
 Top Head Diameter: 13mm
 Stem Length: 18mm
 Black Nylon
 Door Trim Panel Retainers
 AMC # 4005099
 25 Pcs.

2112PK

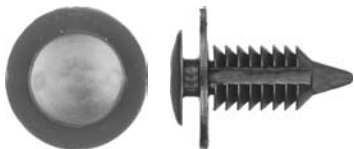

17/64" (7mm) Hole Size
 Top Head Diameter: 12.5mm
 Stem Length: 19mm
 Black Nylon
 Door Trim Panel Retainers
 Ford # N805155-S
 50 Pcs.

10719PK

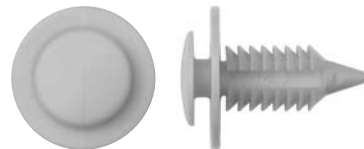

17/64" (7mm) Hole Size
 Top Head Diameter: 12.5mm
 Stem Length: 19mm
 Yellow Nylon
 Door Trim Panel Retainers
 Ford
 50 Pcs.

6

1558PK

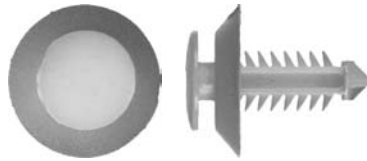

17/64" (7mm) Hole Size
 Top Head Diameter: 13.3mm
 Stem Length: 19mm
 Natural Nylon
 Door Trim Panel Retainers
 Ford # N802900
 25 Pcs.

9514PK

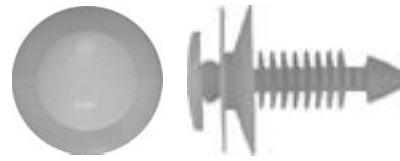

17/64" (7mm) Hole Size
 Top Head Diameter: 13mm
 Stem Length: 22mm
 Natural Nylon
 Door Trim Panel Retainers
 Ford # 389144-S
 50 Pcs.

1648PK



17/64" (7mm) Hole Size
 Top Head Diameter: 20mm
 Stem Length: 24mm
 White Nylon
 Door Panel Trim Retainers
 Ford # 387496-S
 25 Pcs.

9021PK



5/16" (8mm) Hole Size
 Top Head Diameter: 13.15mm
 Black Nylon
 Back Seat
 Door Trim Panel Retainers
 Ford # 387182-S
 25 Pcs.

1742PK

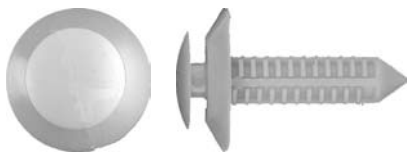

5/16" (8mm) Hole Size
 Top Head Diameter: 1/2"
 Stem Length: 1"
 Natural Nylon
 Door Trim Panel Retainers
 Ford # N805612-S100
 50 Pcs.

10649PK



17/64" (7mm) Hole Size
 Top Head Diameter: 15mm
 Stem Length: 14.6mm
 Yellow Nylon
 Door Trim Panel Retainers
 Chrysler # 6507055-AA
 50 Pcs.



10576PK



5/16" (8mm) Hole Size
 Top Head Diameter: 12.8mm
 Stem Length: 14mm
 Orange Nylon With Sealer
 Door Trim Panel Retainers
 Nissan # 80999-VE000
 25 Pcs.

10671PK

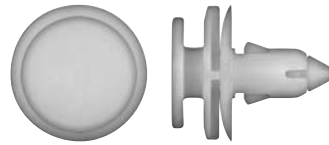

17/64" (7mm) Hole Size
 Top Head Diameter: 15mm
 Stem Length: 15mm
 White Nylon
 Door Trim Panel Retainers
 Chrysler # 6505539AA
 25 Pcs.

2063PK



17/64" (7mm) Hole Size
 Top Head Diameter: 13mm
 Stem Length: 15mm
 White Nylon
 Door Trim Panel Retainers
 Chrysler # 6504014
 50 Pcs.

9380PK

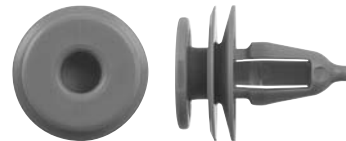

17/64" (7mm) Hole Size
 Top Head Diameter: 15mm
 Stem Length: 15mm
 Green Nylon
 Door Trim Panel Clips
 Chrysler # 6503204
 50 Pc.

10703PK



9/32" (7.4mm) Hole Size
 Top Head Diameter: 17mm
 Stem Length: 14mm
 White Nylon
 Door Trim Panel Retainers
 G.M. # 90321122
 50 Pcs.

9379PK

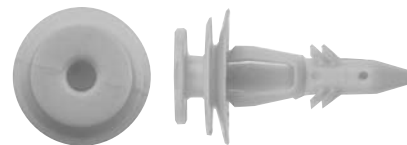

19/64" (7.5mm) Hole Size
 Top Head Diameter: 13mm
 Stem Length: 26mm
 Yellow Nylon
 Tail Gate & Trim Panel Retainers
 Chrysler # 6502991
 25 Pcs.

6

10098PK

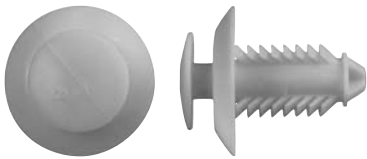

5/16" (7.9mm) Hole Size
 Top Head Diameter: 1/2"
 Stem Length: 3/4"
 Yellow Nylon
 Door Trim Panel Retainers
 Ford # F58Z-16237A02-A
 25 Pcs.

10947PK

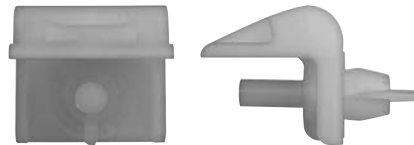

17/64" (7mm) Hole Size
 Base Size: 19mm x 20.5mm
 Stem Length: 6mm
 Natural Nylon
 Door Trim Panel Retainers
 V.W. # 321-867-299B
 15 Pcs.

10932PK



19/64" (7.5mm) Hole Size
 Top Head Diameter: 28mm
 Stem Length: 11mm
 Black Nylon
 Door Trim Panel Retainers
 V.W. # 6K0-868-243
 25 Pcs.

1201PK

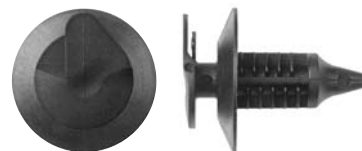

5/16" (8mm) Hole Size
 Top Head Diameter: 12.6mm
 Stem Length: 18mm
 Black Nylon
 Door Trim Panel Retainers
 V.W. # 175-867-299
 50 Pcs.

1575PK



5/16" (8mm) Hole Size
 Top Head Diameter: 1/2"
 Stem Length: 3/4"
 Black Nylon
 Door Trim Panel Retainers
 Ford # N801925-S
 25 Pcs.

9372PK



5/16" (8mm) Hole Size
 Top Head Diameter: 1/2"
 Stem Length: 21/32"
 White Nylon
 Door Trim Panel Retainers
 Ford # 387477-S
 50 Pcs.

10610PK

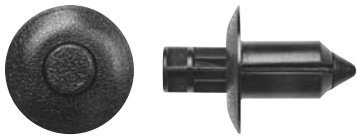

5/16" (8mm) Hole Size
 Flange Diameter: 17mm
 Stem Length: 12mm
 Black Nylon
 Door Panel Retainers
 Honda # 91505-ST7-003ZA
 10 Pcs.

9444PK

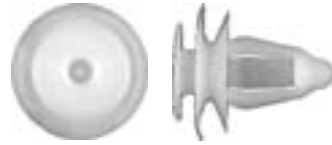

5/16" (8mm) Hole Size
 Top Head Diameter: 13mm
 Stem Length: 15mm
 White Nylon
 Door Trim Panel Retainers
 Honda # 91560-SM4-003
 25 Pcs.

10575PK



5/16" (8mm) Hole Size
 Top Head Diameter: 15mm
 Stem Length: 10mm
 Black Nylon
 Door Trim Panel Retainers
 Mazda # GA2A-68-AB1A
 10 Pcs.

9539PK



5/16" (8mm) Hole Size
 Top Head Diameter: 13mm
 Stem Length: 17.5mm
 Natural Nylon
 Door Trim Panel Retainers
 Nissan # 01553-S3500
 50 Pcs.

10924PK



5/16" (8mm) Hole Size
 Top Head Diameter: 13.5mm
 Stem Length: 14.5mm
 Natural Nylon
 Door Trim Panel Retainers
 V. W. # 171-807-249A
 25 Pcs.

10945PK

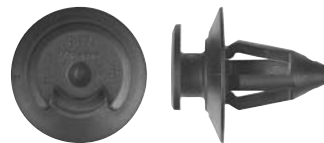

5/16" (8mm) Hole Size
 Top Head Diameter: 13.5mm
 Stem Length: 14mm
 Black Nylon
 Door Trim Panel Retainers
 V.W. # 823-867-299
 25 Pcs.

6

10930PK

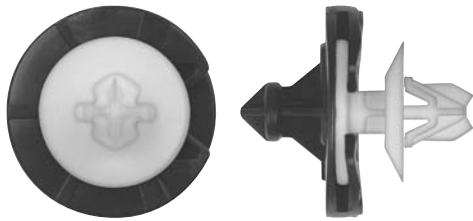

5/16" (8mm) Hole Size
 Head Diameter: 28mm
 Stem Length: 11mm
 Natural & Black Nylon
 Interior Trim Retainers
 V.W. # 1H0-868-243
 25 Pcs.

10884PK

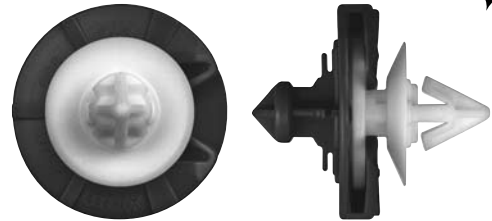

5/16" (8mm) Hole Size
 Head Diameter: 28.5mm
 Stem Length: 12.5mm
 Double Ended White/Tan Nylon
 Door Trim Panel Retainers
 V.W. # 1H0868243B
 15 Pcs.

10933PK



5/16" (8mm) Hole Size
 Head: 28.3mm Stem: 12mm
 Natural & Black Nylon
 Double Ended
 Interior Trim Retainers
 V.W. # 6N0-868-243A
 25 Pcs.

10916PK

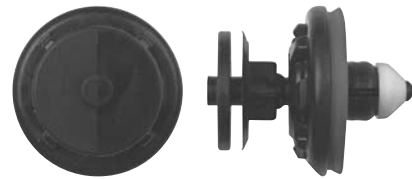

5/16" (8mm) Hole Size
 Top Head Diameter: 16mm
 Stem Length: 10.5mm
 Black Nylon With Sealer
 Door Trim Panel Retainers
 V.W. # 6Q0-868-243
 25 Pcs.

10920PK

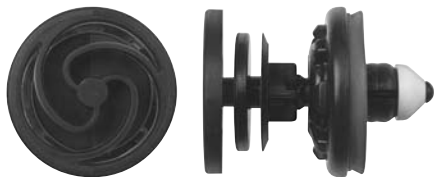

5/16" (8mm) Hole Size
 Top Head Diameter: 22mm
 Stem Length: 11mm
 Black Nylon With Sealer
 Door Trim Panel Retainers
 V.W. # 7L6-868-243
 25 Pcs.

10931PK



5/16" (8mm) Hole Size
 Top Head Diameter: 22mm
 Stem Length: 12.5mm
 Black Nylon
 Trim Panel Retainers
 V.W. # 6K0-868-243C
 25 Pcs.

10788PK

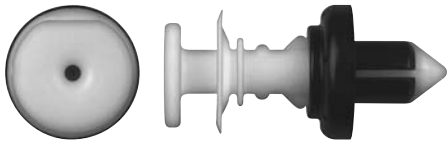

21/64" (8.3mm) Hole Size
 Top Head Diameter: 15mm
 Stem Length: 13mm
 White and Black Nylon
 Interior Trim Panel Retainers
 Honda # 91561-SJD-003
 15 Pcs.

10573PK



11/32" (8.5mm) Hole Size
 Top Head Diameter: 13mm
 Stem Length: 13mm
 Blue Nylon
 Door Trim Panel Retainers
 Honda # 91560-S9A-A01
 25 Pcs.

10724PK

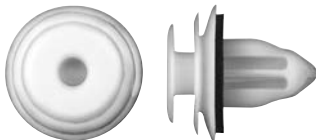

11/32" (8.5mm) Hole Size
 Top Head Diameter: 13mm
 Stem Length: 14mm
 White Nylon With Sealer
 Door Trim Panel Retainers
 Toyota # 90467-A0005
 15 Pcs.

10687PK

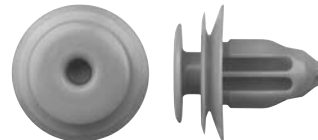

11/32" (8.5mm) Hole Size
 Top Head Diameter: 13mm
 Stem Length: 14mm
 Turquoise Nylon
 Door Trim Panel Retainers
 Toyota # 90467-10188
 25 Pcs.

10927PK



11/32" (8.5mm) Hole Size
 Top Head Diameter: 13mm
 Stem Length: 16mm
 Yellow Nylon
 Interior Panel Trim Retainers
 V.W. # 7M0-867-299K
 25 Pcs.

10751PK



11/32" (8.75mm) Hole Size
 Top Head Diameter: 13mm
 Stem Length: 11mm
 White Nylon
 Garnish Moulding Retainers
 Toyota # 62217-13010
 25 Pcs.

6

10744PK

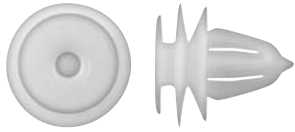

23/64" (8.8mm) Hole Size
 Top Head Diameter: 13mm
 Stem Length: 10mm
 Natural Nylon
 Trim Panel Retainers
 Hyundai # 82315-38000
 25 Pcs.

10701PK

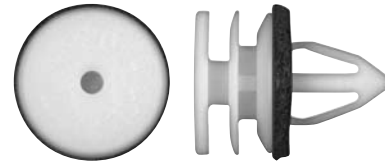

23/64" (9mm) Hole Size
 Top Head Diameter: 19.5mm
 Stem Length: 18mm
 White Nylon With Sealer
 Door Trim Panel Retainers
 G.M. # 11519031
 15 Pcs.

10470PK

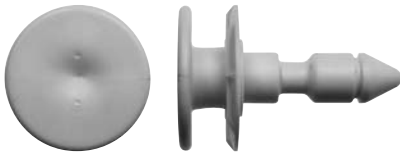

Top Head Diameter: 19.5mm
 Stem Length: 30.4mm
 Yellow Nylon
 Door Panel Pins
 Use with # 10478 & 10476
 G.M. # 11561600
 25 Pcs.

10471PK

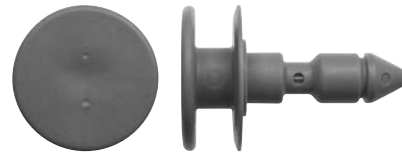

Top Head Diameter: 19.5mm
 Stem Length: 30.4mm
 Green Nylon
 Door Panel Pins
 Use with # 10478
 G.M. # 11562242
 25 Pcs.

10472PK



Top Head Diameter: 19.5mm
 Stem Length: 28.3mm
 Black Nylon
 Door Panel Pins
 Use with # 10476
 G.M. # 11562241
 25 Pcs.

10473PK



Top Head Diameter: 19.5mm
 Stem Length: 28.3mm
 White Nylon
 Door Panel Pins
 Use with # 10476
 G.M. # 11561499
 25 Pcs.

6

10474PK



Top Head Diameter: 13mm
 Stem Length: 26.5mm
 White Nylon
 Door Panel Pins
 Use with # 10476
 G.M. # 10363811
 25 Pcs.

10529

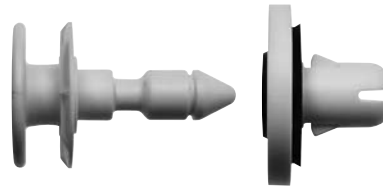

23/64" (9mm) Hole Size
 Yellow Pin
 Yellow Nut With Sealer
 Two Part Nylon
 Door Panel Retainers
 G.M. # 11562044
 15 Pcs.

10530

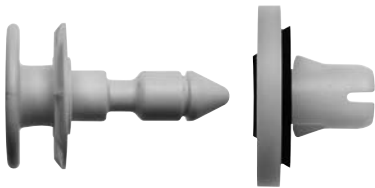

23/64" (9mm) Hole Size
 Yellow Pin
 White Nut With Sealer
 Two Part Nylon
 Door Panel Retainers
 G.M. # 11562288
 15 Pcs.

10531

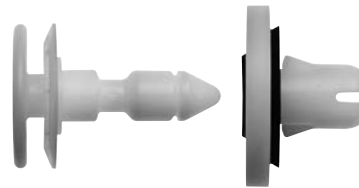

23/64" (9mm) Hole Size
 White Pin
 White Nut With Sealer
 Two Part Nylon
 Door Panel Retainers
 G.M. # 11562043
 15 Pcs.

10532

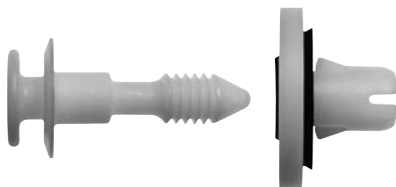

23/64" (9mm) Hole Size
 White Pin
 White Nut With Sealer
 Two Part Nylon
 Door Panel Retainers
 G.M. # 22699649
 25 Pcs.

10533

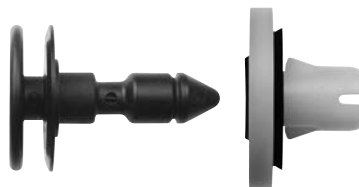

23/64" (9mm) Hole Size
 Black Pin
 White Nut With Sealer
 Two Part Nylon
 Door Panel Retainers
 G.M. # 11562256
 15 Pcs.

6

10534

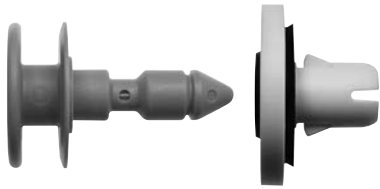

23/64" (9mm) Hole Size
Green Pin
Yellow Nut With Sealer
Two Part Nylon
Door Panel Retainers
G.M. # 11562257
15 Pcs.

10476PK

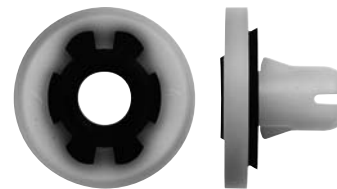

23/64" (9mm) Hole Size
White Nylon With Sealer
Door Panel Nuts
Use with # 10470, 10472,
10473 & 10474
G.M. # 22722860
25 Pcs.

10478PK

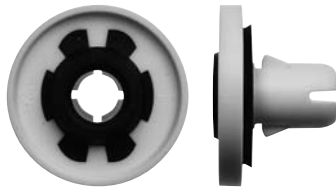

23/64" (9mm) Hole Size
Yellow Nylon With Sealer
Door Panel Nuts
Use with # 10470 & 10471
G.M. # 11561500
25 Pcs.

10466PK

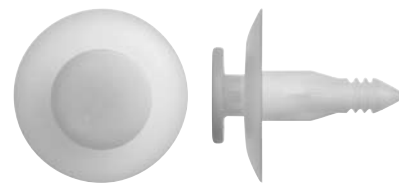

Top Head Diameter: 13mm
Flange Diameter: 23mm
White Nylon
Door Panel Retainers
Use With # 10467
25 Pcs.

10467PK

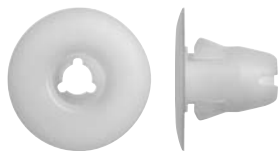

23/64" (9mm) Hole Size
Head Diameter: 19mm
White Nylon
Door Panel Nuts
Use With # 10466
Chrysler # 6506655AA
25 Pcs.

2144PK



23/64" (9mm) Hole Size
Top Head Diameter: 12.6mm
Stem Length: 14mm
White Nylon
Door Trim Panel Retainers
Honda # 91566-SP0-003
15 Pcs.

2145PK

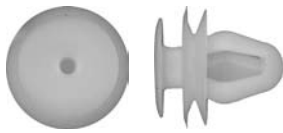

23/64" (9mm) Hole Size
 Top Head Diameter : 13mm
 Stem Length: 11mm
 Natural Nylon
 Door Trim & Garnish Retainers
 Toyota # 67771-30070
 25 Pcs.

10612PK



23/64" (9mm) Hole Size
 Top Head Diameter: 16mm
 Stem Length: 17mm
 White Nylon With Sealer
 Door Trim Panel Retainers
 Ford # W713297-S300
 25 Pcs.

10494PK



23/64" (9mm) Hole Size
 Top Head Diameter: 16mm
 Stem Length: 15.4mm
 White Nylon
 Door Trim Panel Retainers
 Chrysler # 5023111AA
 15 Pcs.

10774PK



23/64" (9mm) Hole Size
 Top Head Diameter: 15mm
 Stem Length: 12mm
 Neon Pink Nylon
 Door Trim Panel Retainers
 Hyundai # 82315-27000
 15 Pcs.

10773PK



23/64" (9mm) Hole Size
 Top Head Diameter: 13mm
 Stem Length: 13mm
 Gray Nylon
 Trim Panel Retainers
 Hyundai # 85849-3B000
 25 Pcs.

10405PK



23/64" (9mm) Hole Size
 Top Head Diameter: 14mm
 Stem Length: 14mm
 White Nylon
 Door Trim Panel Retainers
 Mazda # 9927-40-822
 25 Pcs.

6

10748PK



23/64" (9mm) Hole Size
 Top Head Dia: 13mm Stem: 13mm
 White Nylon
 Door Panel &
 Rocker Moulding Retainers
 Toyota # 67771-12080
 15 Pcs.

9081PK



23/64" (9mm) Hole Size
 Top Head Diameter: 13mm
 Stem Length: 14mm
 White Nylon
 Door Trim Panel Retainers
 Toyota # 67771-01010
 25 Pcs.

1588PK



23/64" (9mm) Hole Size
 Top Head Diameter: 13mm
 Stem Length: 14mm
 Black Nylon
 Door Trim Panel Retainers
 Toyota # 67771-01010
 25 Pcs.

10939PK



23/64" (9mm) Hole Size
 Top Head Diameter: 12mm
 Stem Length: 11mm
 White Nylon
 Fender Moulding Trim Retainers
 V.W. # 191-853-585A
 25 Pcs.

10464PK



3/8" (9.5mm) Hole Size
 Top Head Diameter: 15mm
 Stem Length: 14mm
 Yellow & White Nylon
 Door Trim Panel Retainers
 Chrysler # 6505918-AA
 25 Pcs.

2108PK



3/8" (9.5mm) Hole Size
 Top Head Diameter: 15mm
 Stem Length: 14mm
 White Nylon
 Door Trim Panel Retainers
 Chrysler # 6505292AA
 25 Pcs.

10463PK



3/8" (9.5mm) Hole Size
 Top Head Diameter: 15mm
 Stem Length: 16.8mm
 Green & White Nylon
 Door Trim Panel Retainers
 Chrysler # 5028438-AA
 25 Pcs.

10465PK



3/8" (9.5mm) Hole Size
 Top Head Diameter: 15mm
 Stem Length: 18mm
 Gray & White Nylon
 Door Trim Panel Retainers
 Chrysler # 6505759AA
 25 Pcs.

10667PK

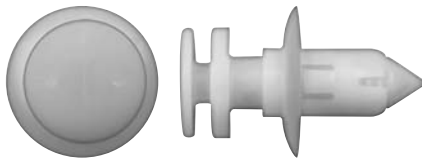

25/64" (10mm) Hole Size
 Top Head Diameter: 15mm
 Stem Length: 19.5mm
 Natural Nylon
 Door Trim Panel Retainers
 Ford # 1W6Z-238A90-AA
 25 Pcs.

10952PK



25/64" (10mm) Hole Size
 Head Diameter: 22mm
 Stem Length: 10mm
 Black Nylon
 Door Trim Panel Retainers
 V.W. # 3B0-868-243
 25 pcs.

10917PK

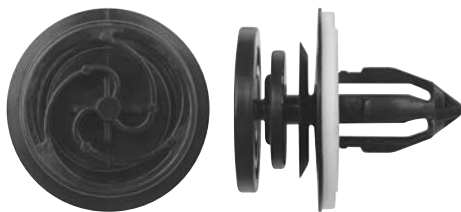

25/64" (10mm) Hole Size
 Top Head Diameter: 21.5mm
 Stem Length: 19mm
 Black Nylon With Sealer
 Door Trim Panel Retainers
 V.W. # 8E0-868-243
 25 Pcs

10749PK



7/16" (11.1mm) Hole Size
 Top Head Diameter: 14mm
 Stem Length: 14mm
 White Nylon With Sealer
 Door Trim Panel Retainers
 Mazda # G18K-51-SJ3
 10 Pcs.

6

10581

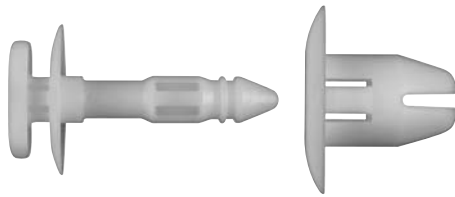

15/32" (12mm) Hole Size
Window Lift Motor Mounting
Natural Nylon
Drive Type Rivet
Pin & Grommet Kit
Chrysler
25 Pcs.

10584



15/32" (12mm) Hole Size
Window Lift Motor Mounting
Natural Nylon
Drive Type Rivet
Pin & Grommet Kit
Chrysler
25 Pcs.

10477PK



1/2" (12.7mm) Hole Size
Top Head Diameter: 16mm
Stem Length: 25mm
Natural Nylon
Door Panel Retainers
Chrysler
25 Pcs.

10582PK



1/4" (6.2mm) Hole Size
Window Lift Motor Mounting
Natural Nylon
Drive Type Rivet Pins
Used with # 10583
Chrysler
25 Pcs.

10583PK

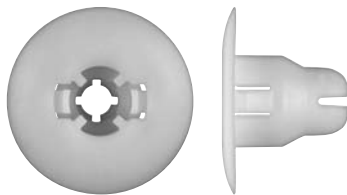

1/2" (12.7mm) Hole Size
Window Lift Motor Mounting
Natural Nylon
Drive Type Rivet Grommets
Used with # 10582
Chrysler
25 Pcs.

10579PK

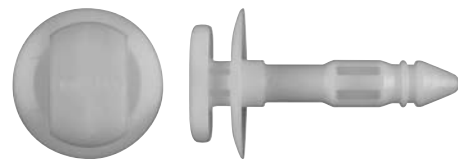

(1/4") 6.3mm Hole Size
Window Lift Motor Mounting
Natural Nylon
Drive Type Rivet Pins
Used with # 10580
Chrysler
25 Pcs.

10580PK

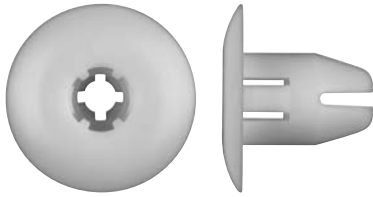

1/2" (12.7mm) Hole Size
Window Lift Motor Mounting
Natural Nylon
Drive Type Rivet Grommets
Used with # 10579
Chrysler
25 Pcs.

4011PK



Some Installations
may require
5/8" Washer
(Some provided)

Remove & Resetting Door Glass
Made Easy, Fits Most:
Ford, G.M., Chry. Products
Black Zytel Nylon
Door Glass Replacement Kits
50 Pcs.

10479PK

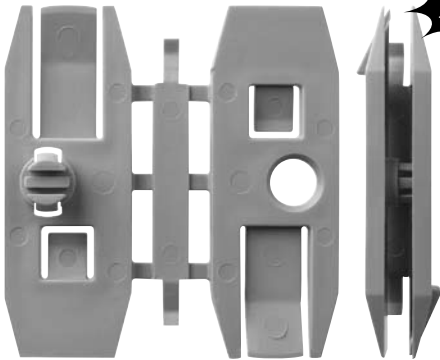

Photo Not Actual Size
Assembled Over All Size 1" x 2 3/8"
Gray Nylon Front Door Window Guides
G.M. # 15786626
10 Pcs.

1566PK



Rear of Glass
Black Nylon
Front Door Glass
Window Guide Retainers
G.M. # 22539533
15 Pcs.

1563PK



Upper Part of Glass
Black Nylon
Front Door Glass
Window Guide Retainers
G.M. # 20160591
25 Pcs.

1568PK



Black Nylon
Front Door Glass
Window Guide Retainers
G.M. # 20162174
25 Pcs.

6

1681PK



2 3/4" X 1 3/4" Over All Size
Black Nylon
Front Door Glass
Window Guide Retainers
G.M. # 12337898
15 Pcs.

1562PK



Black Nylon
Front & Rear Door Glass
Window Guide Retainers
G.M. # 20328600
25 Pcs.

9421PK



2 3/4" x 1 3/4" Over All Size
Front of Glass 4mm Thick
Black Nylon
Front Door Glass
Window Guide Retainers
G.M. # 20712176
15 Pcs.

1570PK

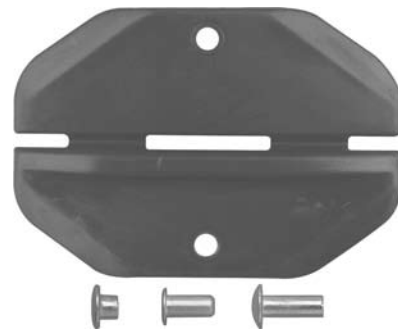

Includes Rivets
Window Guide Retainers
Chrysler # 4339372
25 Pcs.

9635PK



1 5/16" Height
6" Over All Length
Black Plastic
Front Door Glass
Window Guides Retainers
G.M. # 20180140
25 Pcs.

10107

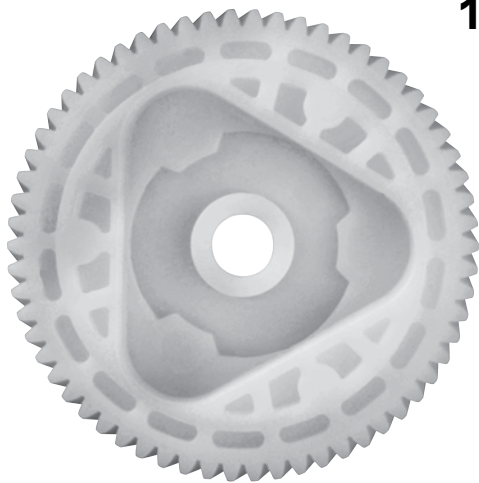

Contains 1 Gear # 10108 & 3 Pins # 9392
Window Lift Motor Gear Kit
1 Kit

6

9233PK



1/64" Thick
21/64" I.D. 9/16" O.D.
Stainless Steel
Door Hinge Pin Retainers
(Use with # 9164PK)
G.M. # 15562610
50 Pcs.

1269PK



.269" I.D.
.316" O.D.
.356" Height
Door Hinge Pin Bushings
Chrysler # 4033711
25 Pcs.

1267PK



.345" I.D.
.419" O.D.
.295" Height
Door Hinge Pin Bushings
G.M. # 9721917
25 Pcs.

9805PK



.387" I.D.
 .472" O.D.
 .262" Height
 Door Hinge Pin Bushings
 1 Pc.

1270PK



.348" I.D.
 .479" O.D.
 .296" Height
 Door Hinge Pin Bushings
 Ford # D90Z-6522841A
 25 Pcs.

9965PK



.374" I.D.
 .495" O.D.
 .322" Height
 Door Hinge Pin Bushings
 1 Pc.

1251PK



.384" I.D.
 .501" O.D.
 .460" Height
 Door Hinge Pin Bushings
 G.M. # 9822198
 25 Pcs.

1252PK



.346" I.D.
 .490" O.D.
 .375" Height
 Door Hinge Pin Bushings
 G.M. # 9716926
 25 Pcs.

2115PK



.385" I.D.
 .530" O.D.
 .365 Height
 Door Hinge Pin Bushings
 G.M. # 15562609
 25 Pcs.

1268PK



.345" I.D.
.489" O.D.
.362" Height
Door Hinge Pin Bushings
G.M. # 20429500
25 Pcs.

2114PK



.345" I.D.
.495" O.D.
.365" Height
Door Hinge Pin Bushings
G.M. # 12338074
25 Pcs.

10061PK



(Yellow Zinc Finish)

O.A. Length: 2"
Thread Pitch: 5/16"- 24
Long Type
Door Hinge Pin
1 Pc.

10062PK



(Yellow Zinc Finish)

O.A. Length: 1 7/8"
Thread Pitch: 5/16"- 24
Short Type
Door Hinge Pin
1 Pc.

1289PK



(Black Zinc Finish)

11/32" Pin Diameter
Length: 4"
Head O.D.: 7/16"
Door Hinge Pins
G.M. # 20043351
10 Pcs.

6

1288PK



(Zinc Finish)

11/32" Pin Diameter
Length: 4 1/16"
Head O.D. : 9/16"
Door Hinge Pins
G.M. # 6271989
10 Pcs.

9825PK

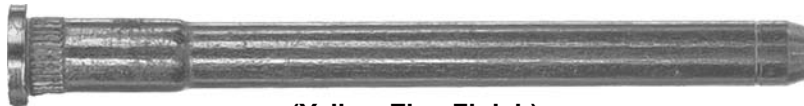

(Yellow Zinc Finish)

11/32" Pin Diameter
Length: 4 1/8"
Head O.D. : 1/2"
Door Hinge Pins
G.M. # 15653790
2 Pcs.

9164PK



(Stainless Steel)

11/32" Pin Diameter
5 1/4" Length
Stainless Steel
Door Hinge Pins
G.M. # 15591860
5 Pcs.

10451PK



(Zinc Finish)

11/32" Pin Diameter
5 1/4" Length
Yellow Zinc Finish Steel
Door Hinge Pins
5 Pcs.

2168PK



(Zinc Finish)

9/16" Pin Diameter
Length: 5 1/2"
Roller Groove Dia. : 5/8"
Kurl Dia. : 19/32"
Door Roller Pin Assembly
G.M. # 12540326
1 Pc.

9595PK

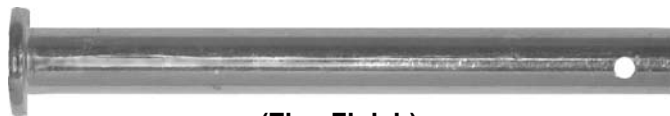

(Zinc Finish)

11/32" Pin Diameter
Length: 3 3/8"
Head O.D. : 9/16"
Door Hinge Pins
Ford # D9ZZ-6643030-AA
10 Pcs.

9937PK



(Zinc Finish)

11/32" Pin Diameter
Length: 3 1/2"
Head O.D.: 9/16"
Ford Ranger, F150, F250 & F350
Door Hinge Pins
Ford # E8UZ1522840
5 Pcs.

1292PK



(Black Finish)

17/64" Pin Diameter
Length: 2 3/4"
Head O.D. : 9/16"
Door Hinge Pins
Chrysler # 6028993
10 Pcs.

9832

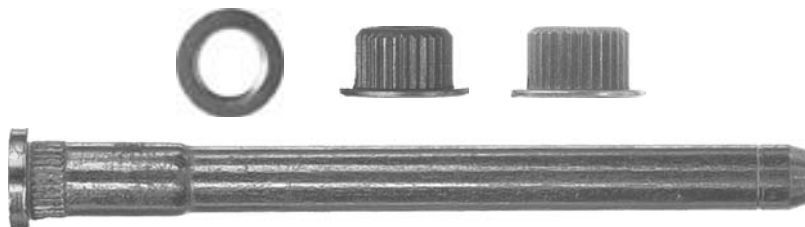

(Yellow Zinc Finish Pin)

G.M. S10 Trucks
1994 - On
Kit Will Repair One Hinge
Door Hinge Pin and Bushing Kit
1 Kit

9833

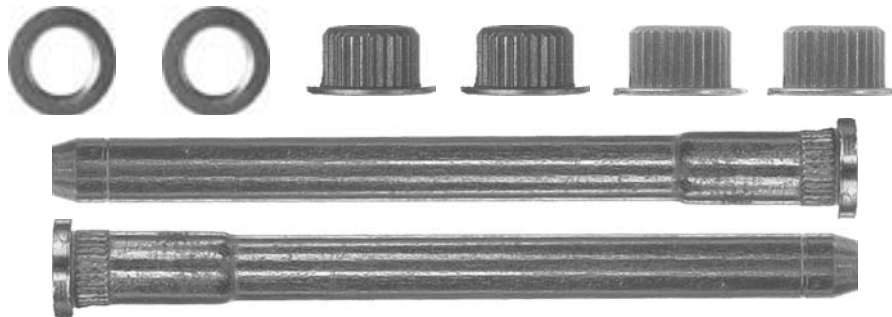

(Yellow Zinc Finish Pins)

G.M. S10 Trucks
1994 - On
Kit Will Repair One Door
Door Hinge Pin and Bushing Kit
1 Kit

9818

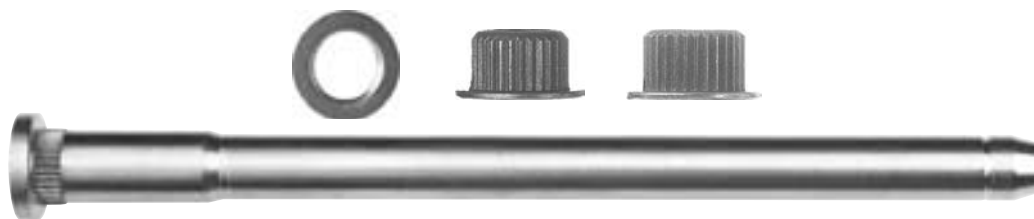

(Stainless Steel Pin)

G.M. Trucks C-K
1988 - On
Kit Will Repair One Hinge
Door Hinge Pin and Bushing Kit
1 Kit

10528

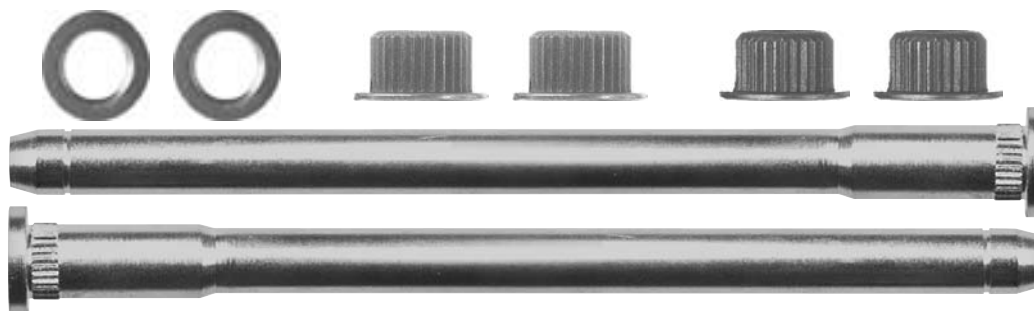

(Zinc Finish Pins)

G.M. Trucks C-K 1988 - On
Kit Will Repair One Door
Door Hinge Pin & Bushing Kit
1 Kit



9905

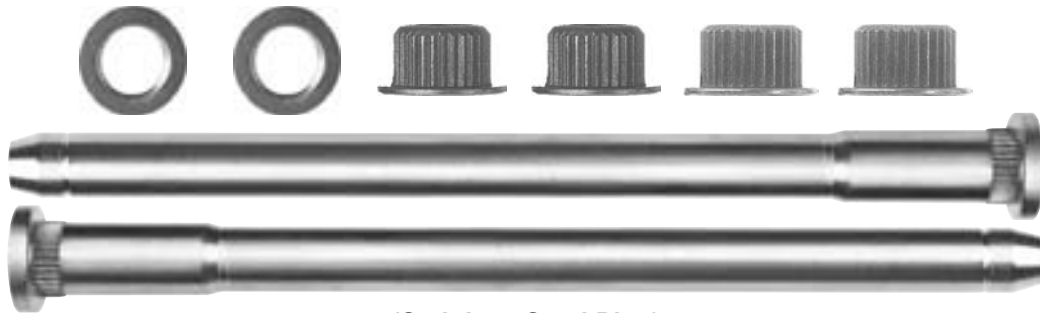

(Stainless Steel Pins)

G.M. Trucks C-K
1988 - On
Kit Will Repair One Door
Door Hinge Pin and Bushing Kit
1 Kit

10527

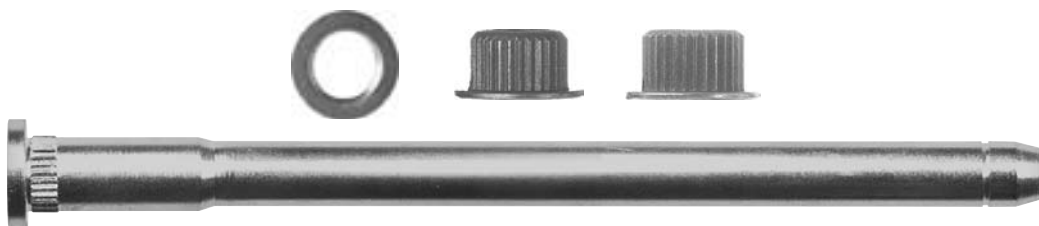

(Zinc Finish Pin)

G.M. Trucks C-K
1988 - On
Kit Will Repair One Hinge
Door Hinge Pin and Bushing Kit
1 Kit

10060



(Yellow Zinc Finish Pins)

Replacement Parts To Replace One Hinge
GMC Sierra & Chev. Silverado & Other S.U.V.'s Hinges
Door Hinge Pin & Bushing Kit
1 Kit

10065

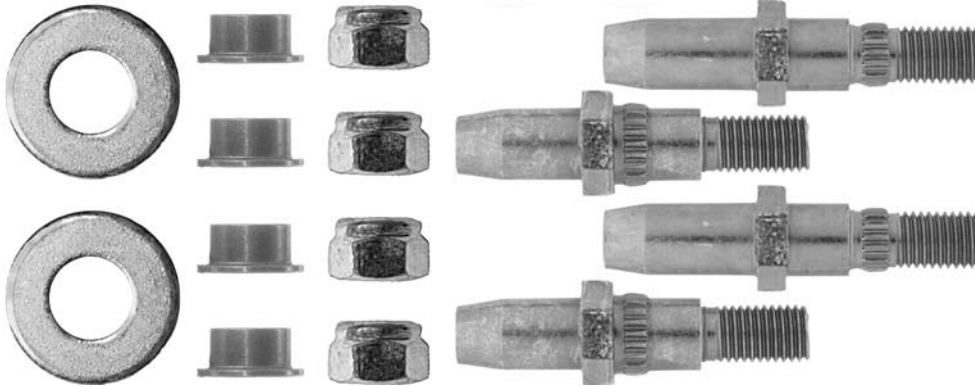

Replacement Parts To Replace One Door
GMC Sierra & Chev. Silverado & Other S.U.V.'s Hinges
Door Hinge Pin & Bushing Kit
1 Kit

6

9948

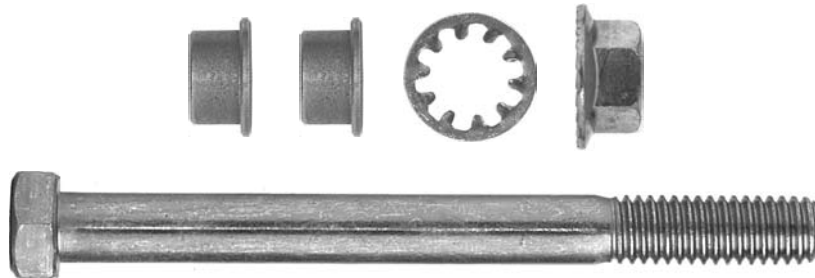

Dodge Trucks
1994 - 2003 Dodge Ram
Kit will Repair One Hinge
Door Hinge Pin & Bushing Kit
1 Kit

9964

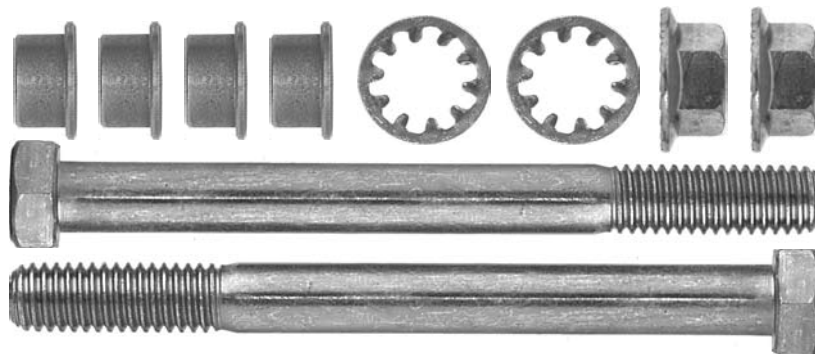

Dodge Trucks
1994-2003 Dodge Ram
Kit Will Repair One Door
Door Hinge Pin & Bushing Kit
1 Kit

9939

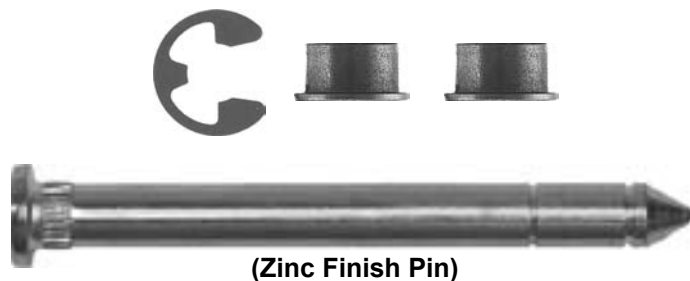

(Zinc Finish Pin)

Ford F - Series 1980 - 98
Kit Will Repair One Hinge
Door Hinge Pin and Bushing Kit
1 Kit

9940

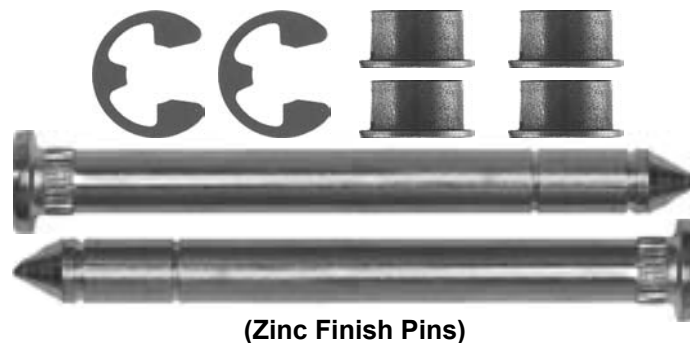

(Zinc Finish Pins)

Ford F - Series 1980 - 98
Kit Will Repair One Door
Door Hinge Pin and Bushing Kit
1 Kit

9906

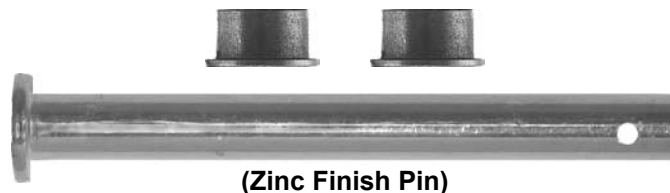

(Zinc Finish Pin)

Topaz & Tempo 1990 - 94
Mustang 1979 - 93, Capri 1980 - 86
Kit Will Repair One Hinge
Door Hinge Pin and Bushing Kit
1 Kit

10558



**Side Cargo Door
Greaseable Stainless Steel Door Hinge Pin & Bushing Kit
Chev. Savana & G.M.C. Express Van Side Doors
Repairs One Hinge
1 Kit**

10699



**Side Cargo Door
Greaseable Stainless Steel Door Hinge Pin & Bushing Kit
Chev. Savana & G.M.C. Express Van Side Doors
Repairs One Door
1 Kit**

10559



**Side Cargo Door Replacement Hinge
Chev. Savana & G.M.C. Express Van Side Doors
Use with # 10699
Sold Each**

6



Headlight Fasteners

996PK



1/4-28 x 2" Screw
Bright Zinc Finish
Headlight Adjusting Screws
G.M. # 343543
25 Pcs.

656PK

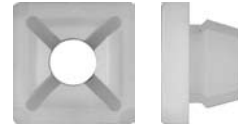

1/4-28 Screw Size
Black Nylon
Headlight Adjusting Nuts
G.M. # 3921446
50 Pcs.

972PK



1/4-28 x 2" Screw
White Nylon Nut
Headlight Adjusting
Screw & Nut Assembly
G.M. # 343543
10 Pcs.

1003PK

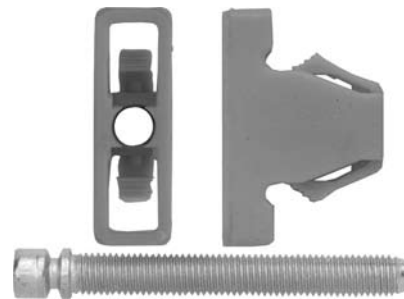

12-28 x 2" Screw
Blue Nylon Nut
Headlight Adjusting
Screw & Nut Assembly
G.M. # 556196
25 Pcs.

1019PK



1/4-28 x 2" Screw
Green Nylon Nut
Headlight Adjusting
Screw & Nut Assembly
G.M. # 365270
25 Pcs.

681PK



12-28 x 2" Screw
White Nylon Nut
Headlight Adjusting
Screw & Nut Assembly
Chrysler # 3574085
10 Pcs.

7

853PK



1/4-28 x 2" Screw
Pink Nylon Nut
Headlight Adjusting
Screw & Nut Assembly
G.M. # 1606642
25 Pcs.

1107PK



8 Screw Size
Headlight Panel
Retainers
G.M. # 25501771
50 Pcs.

10106PK

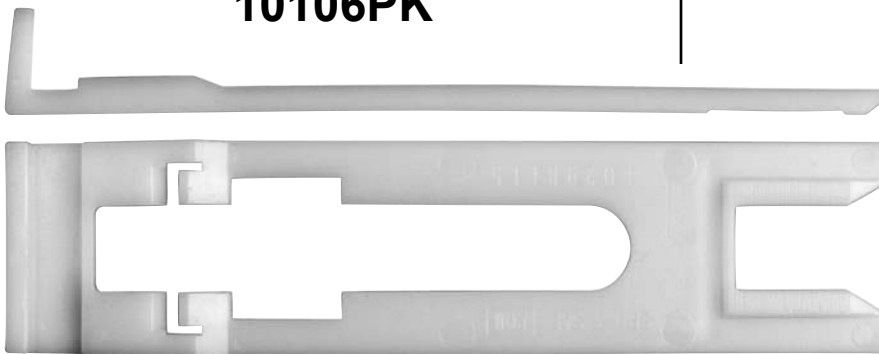

1 1/8" Wide
4 9/16" Long
Natural Nylon
Headlight Retainers
G.M. # 10298115
10 Pcs.

1864PK



Headlight Component
Retaining Clips
Ford # E9DB-13N020AA
25 Pcs.

9720PK



Rear Light
Assembly Retainers
Ford # N806624-S191
25 Pcs.

9199PK



#8 Screw Size
Black Finish
Radiator Grille Nuts
G.M. # 15686142
25 Pcs.

9082PK



13mm Wide
22 mm Long
Grille Clips
Isuzu # 8942180270
25 Pcs.

1932PK



Radiator
Grille Clips
Toyota # 90467-17004
10 Pcs.

1436PK



13mm Wide
23mm Long
Grille Clips
Toyota # 90467-13005
25 Pcs.

10633PK



5/8" Width 1" Length
5/8" Overall Height
Black Finish
Radiator Grille &
Bumper Cover Fasteners
G.M. # 15078238
15 Pcs.

1585PK



Bright Zinc Finish
Front Bumper
Cushion Clips
Toyota # 90183-03001
25 Pcs.

1584PK

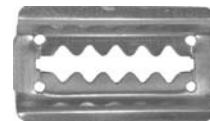

Bright Zinc Finish
Bumper Strip
Retainers
Toyota # 90468-04030
25 Pcs.

7

9809PK

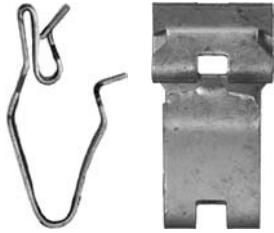

Zinc Plated
Radiator
Grille Retainers
G.M. # 15002520
25 Pcs.

10969PK



6-1.0mm Thread
Hole Size: 12mm x 20mm
Material Thickness: .7mm to 1.8mm
Zinc Organic
Headlight Mounting Clips
Ford # W710793-S439
10 Pcs.

10778PK

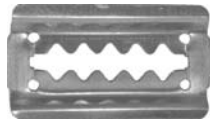

Width: 13mm
Length: 30mm
Stainless Steel
Bumper & Grille Retainers
Hyundai #86593-2400
25 Pcs.



Miscellaneous

1026PK



Width: 23/64"
 Length: 13/16"
 White Nylon
 Vinyl Top Moulding Clips
 G.M. # 1688094
 50 Pcs.

1159PK



Width: 7/16"
 Length: 31/32"
 White Nylon
 Quarter Belt
 Reveal Moulding Clips
 G.M. # 20199675
 50 Pcs.

9853PK



Width: 7/16"
 Length: 25/32"
 Natural Nylon
 Quarter Panel and Reveal
 Moulding Clips
 G.M. # 7731589
 100 Pcs.

987PK



Width: 33/64"
 Length: 27/32"
 Gray Nylon
 Body Side Moulding Clips
 G.M. # 9838109
 100 Pcs.

9895PK



Width: 31/64"
 Length: 57/64"
 White Nylon
 Door, Quarter Panel & Rear End
 Moulding Clips
 G.M. # 8799350
 50 Pcs.

1172PK



Width: 9/16"
 Length: 61/64"
 White Nylon
 Quarter Belt
 Reveal Moulding Clips
 G.M. # 20175051
 50 Pcs.

10950PK



Width: 10.2mm
 Length: 32.5mm
 White Nylon
 Windshield Reveal
 Moulding Clips
 V.W. # 1H0-853-733B
 15 Pcs.

10545PK



6mm x 16mm Hole Size
 Width: 11mm Length: 14mm
 White Nylon
 Front & Rear Bumper
 Moulding Clips
 G.M. # 11561857
 25 Pcs.

10804PK



15/64" (6mm) Hole Size
 Width: 12.5mm Length: 28mm
 Yellow Nylon With Sealer
 Side Window Reveal
 Moulding Clips
 GM # 11570512
 10 Pcs.

10679PK

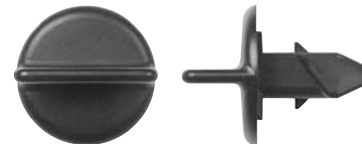

6.5mm x 12.5mm Hole Size
 Black Nylon
 Fascia Trim Cover
 Twist Lock Retainers
 For Escalade, Yukon, Suburban
 G.M. # 11610049
 25 Pcs.

10802PK



17/64" (7mm) Hole Size
 Top Head Dia.: 7.5mm x 11mm
 Stem Length: 13mm
 Green Nylon With Sealer
 Fender Moulding Clips
 G.M. # 11569920
 10 Pcs.

10823PK



17/64" (7mm) Hole Size
 Width: 13mm Length: 30mm
 Stem Length: 13mm
 White Nylon With Sealer
 Roof Rail Moulding Clips
 G.M. # 11569918
 15 Pcs.

10803PK

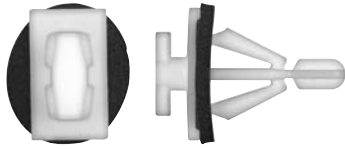

5/16" (8mm) Hole Size
 Top Head Dia.: 6mm x 11mm
 Stem Length: 20mm
 White Nylon With Sealer
 Side Window Moulding Clips
 G.M. # 11610522
 10 pcs.

10805PK

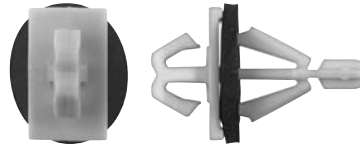

5/16" (8mm) Hole Size
 Top Head Dia.: 10mm x 17mm
 Stem Length: 20mm
 Green Nylon With Sealer
 Window Reveal Moulding Clips
 G.M. # 11569697
 5 Pcs.

9969PK

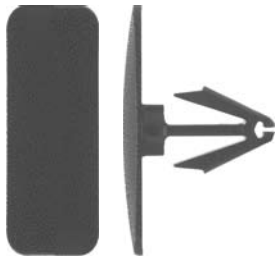

5/16" (8mm) Hole Size
 Head Dia.: 15/32" x 1 5/16"
 Stem Length: 11/16"
 Black Nylon
 Rocker Panel Moulding Clips
 G.M. # 10437565
 10 Pcs.

9967PK

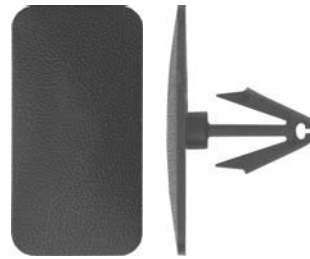

5/16" (8mm) Hole Size
 Head Dia.: 11/16" x 1 5/16"
 Stem Length: 11/16"
 Black Nylon
 Rocker Panel Moulding Clips
 G.M. # 10431524
 15 Pcs.

10489PK

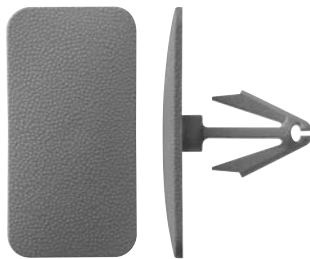

5/16" (8mm) Hole Size
 Head Dia.: 11/16" x 1 5/16"
 Stem Length: 11/16"
 Gray Nylon
 Rocker Panel Moulding Clips
 G.M. # 10352797
 15 Pcs.

10488PK

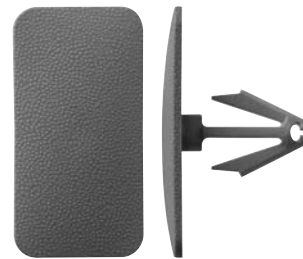

5/16" (8mm) Hole Size
 Head Dia.: 11/16" x 1 5/16"
 Stem Length: 11/16"
 Tan Nylon
 Rocker Panel Moulding Clips
 G.M. # 10431523
 15 Pcs.

10487PK

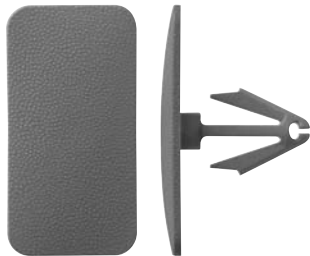

5/16" (8mm) Hole Size
 Head Dia.: 11/16" x 1 5/16"
 Stem Length: 11/16"
 Red Nylon
 Rocker Panel Moulding Clips
 G.M. # 10431526
 15 Pcs.

10484PK

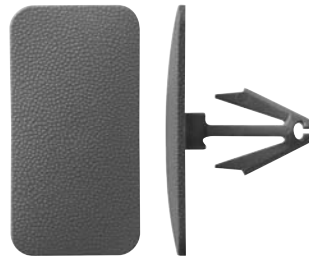

5/16" (8mm) Hole Size
 Head Dia.: 11/16" x 1 5/16"
 Stem Length: 11/16"
 Dark Red Nylon
 Rocker Panel Moulding Clips
 G.M. # 10352800
 15 Pcs.

9915PK

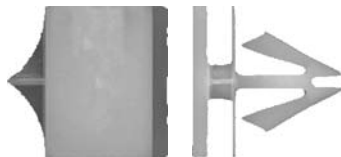

7/16" (11mm) Hole Size
 Top Head Dia.: 9/16" x 3/16"
 Stem Length: 9/16"
 White Nylon
 Rocker Panel Moulding Clips
 G.M. # 10443956
 15 Pcs.

9914PK



7/16" (11mm) Hole Size
 Top Head Dia.: 15/32" x 13/16"
 Stem Length: 9/16"
 Green Nylon
 Rocker Panel Moulding Clips
 G.M. # 10423553
 15 Pcs.

10480PK



23/64" (9mm) Hole Size
 Top Head Dia.: 12mm x 20mm
 Stem Length: 11mm
 White Nylon
 Body Side Moulding Clips
 G.M. # 15127746
 15 Pcs.

10127PK

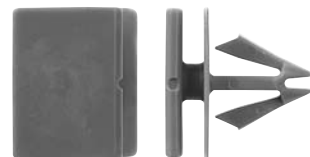

7/16" (11mm) Hole Size
 Top Head Dia.: 9/16" x 3/4"
 Stem Length: 9/16"
 Gray Nylon
 Rocker Panel Moulding Clips
 G.M. # 25693852
 25 Pcs.

10129PK



7/16" (11mm) Hole Size
 Top Head Dia.: 9/16" x 13/16"
 Stem Length: 9/16"
 Natural Nylon With Sealer
 Rocker Panel Moulding Clips
 G.M. # 11518357
 15 Pcs.

9990PK



7/16" (11mm) Hole Size
 Top Head Dia.: 19/32" x 25/32"
 Stem Length: 9/16"
 Yellow Nylon With Sealer
 Rear Wheel Opening Mldg. Clips
 G.M. # 10297371
 15 Pcs.

9991PK



7/16" (11mm) Hole Size
 Top Head Dia.: 15/32" x 25/32"
 Stem Length: 9/16"
 Natural Nylon With Sealer
 Rear Wheel Opening Mldg. Clips
 G.M. # 10297368
 10 Pcs.

9992PK



7/16" (11mm) Hole Size
 Top Head Dia.: 9/16" x 13/16"
 Stem Length: 9/16"
 Black Nylon
 Front Fender W/Opening Mldg. Clips
 G.M. # 10242298
 25 Pcs.

10481PK

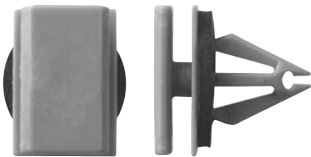

23/64" (9mm) Hole Size
 Top Head Dia.: 12mm x 20mm
 Stem Length: 15mm
 Gray Nylon With Sealer
 Windshield Pillar Mldg. Clips
 G.M. # 15288146
 15 Pcs.

10485PK



23/64" (9mm) Hole Size
 Top Head Dia.: 14mm x 20mm
 Stem Length: 14mm
 Yellow Nylon With Sealer
 Rocker Panel Moulding Clips
 G.M. # 5480852
 10 Pcs.

10357PK

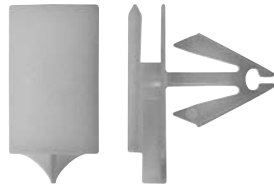

23/64" (9mm) Hole Size
 Top Head Dia.: 12mm x 20mm
 Stem Length: 14mm
 White Nylon
 Rocker Panel Moulding Clips
 G.M. # 10323057
 15 Pcs.

10680PK

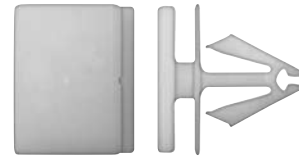

3/8" (9.5mm) Hole Size
 Top Head Dia.: 9/16" x 13/16"
 Stem Length: 9/16"
 White Nylon
 Rocker & Grille Moulding Clips
 G.M. # 25724529
 15 Pcs.

10482PK

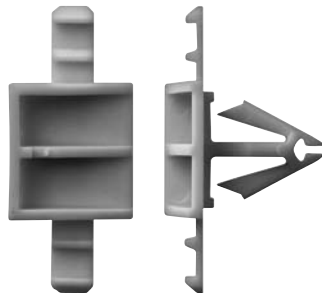

25/64" (10mm) Hole Size
 Top Head Dia.: 16mm x 38mm
 Stem Length: 15mm
 Green Nylon
 Body Side Moulding Clips
 G.M. # 15116576
 15 Pcs.

10827PK

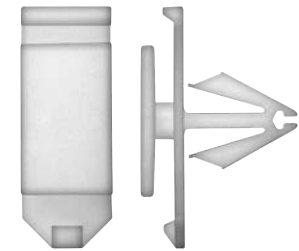

25/64" (10mm) Hole Size
 Top Hd Dia.: 12mm x 20mm
 Stem Length: 15mm
 White Nylon
 Rocker Moulding Clips
 G.M. # 11562563
 15 Pcs.

10056PK

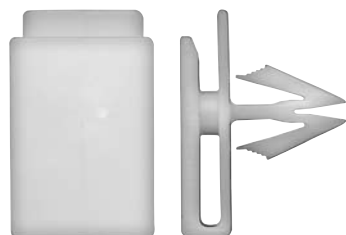

7/16" (11mm) Hole Size
 Top Head Dia.: 3/4" x 1"
 Stem Length: 19/32"
 White Nylon
 Rocker Panel Moulding Clips
 G.M. # 22603384
 15 Pcs.

10429PK

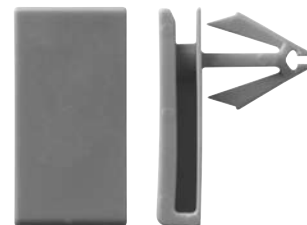

17/64" (7mm) Hole Size
 Top Head Size: 9/16" x 1 1/8"
 Stem Length: 9/16"
 Grey Nylon
 Rocker Panel Moulding Clips
 G.M. # 15221959
 15 Pcs.

10058PK

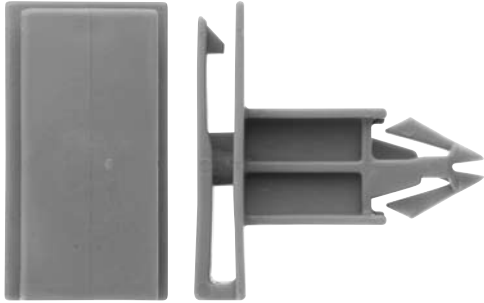

7/16" (11mm) Hole Size
 Top Head Dia.: 11/16" x 1 1/2"
 Stem Length: 1 1/4"
 Gray Nylon
 Rocker Panel Moulding Clips
 G.M. # 10431761
 15 Pcs.

10059PK

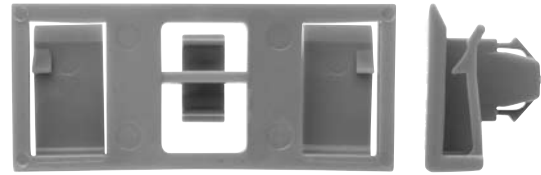

7/16" (11mm) Hole Size
 Width: 7/8" Length: 2"
 Stem Length: 17/32"
 Gray Nylon
 Rocker Panel Moulding Clips
 G.M. 25722671
 10 Pcs.

10128PK

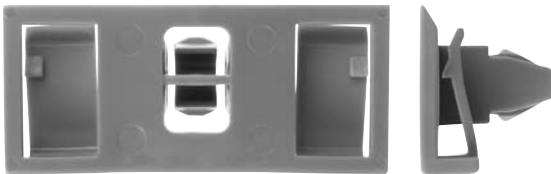

7/16" (11mm) Hole Size
 Width: 7/8" Length: 2"
 Stem Length: 21/32"
 Gray Nylon
 Rocker Panel Moulding Clips
 G.M. # 25648693
 10 Pcs.

10651PK

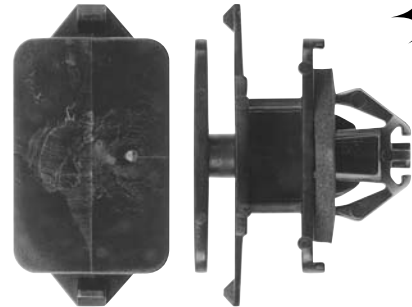

17mm Hole Size
 Top Head Dia.: 20mm x 30mm
 Overall Length: 28mm
 Black Nylon With Sealer
 Rocker Panel Moulding Clips
 G.M. # 11561491
 10 Pcs.

10629PK



Head Dia.: 11mm x 16mm
 Overall Length: 19mm
 Black Nylon
 Rocker Panel Moulding Clips
 Ford # 6G1Z-5410182-D
 25 Pcs.

10691PK



42mm From Tip to Tip
 Front To Back: 12mm
 Height: 21mm
 Roof & Garnish
 Moulding Clips
 Ford # 4L3Z-1510182-AA
 15 Pcs.

10913PK



5/16" (8mm) Hole Size
 Top Head Dia.: 14mm x 18mm
 Stem Length: 11mm
 White Nylon With Sealer
 Windshield Moulding Clips
 Ford # W713590-5300
 15 Pcs.

10066PK

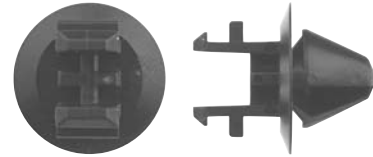

25/64" (10mm) Hole Size
 Head Diameter: 20mm
 Stem Length: 12mm
 Black Nylon
 Radiator Shroud Retainers
 Ford # W708771-S300
 50 Pcs.

2161PK

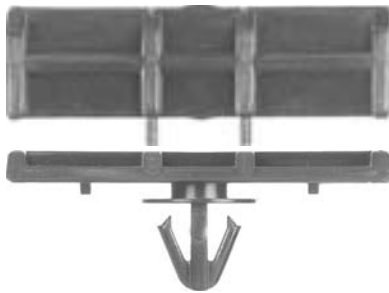

5/16" (7.9mm) Hole Size
 Top Head Dia.: 9/16" x 2"
 Black Nylon
 Rocker Panel Moulding Clips
 Ford # F1TZ-7810182-A
 25 Pcs.

10486PK

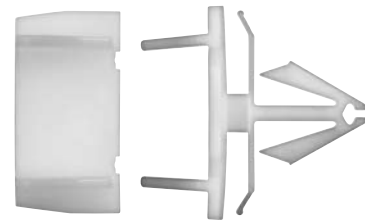

23/64" (9mm) Hole Size
 Top Head Dia.: 14mm x 27mm
 Stem Length: 15mm
 White Nylon
 Rocker Moulding Clips
 Chrysler # 55157069-AB
 25 Pcs.

10483PK

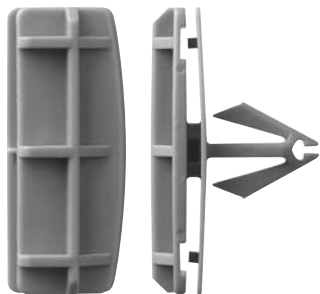

23/64" (9mm) Hole Size
 Top Head Dia.: 14mm x 38mm
 Stem Length: 15mm
 Gray Nylon
 Fender Flare Moulding Clips
 Chrysler # 55157055-AA
 15 Pcs.

10799PK

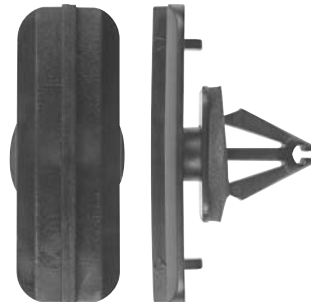

23/64" (9mm) Hole Size
 Top Head Dia.: 14mm x 40mm
 Stem Length: 15mm
 Black Nylon
 Fender Flare Moulding Clips
 Chrysler # 5189181-AA
 10 Pcs.

10800PK

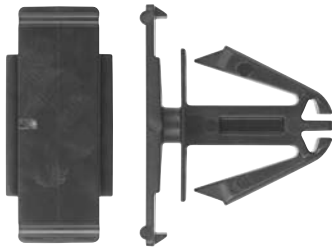

19/32" (15mm) Hole Size
 Top Head Size: 11mm x 32mm
 Stem Length: 20mm
 Black Nylon
 Front Bumper Moulding Clips
 Chrysler # 06508947-AA
 10 Pcs.

1946PK



7/16" (11mm) Hole Size
 Head Dia.: 9.5mm x 10mm
 Stem Length: 14mm
 Green Nylon
 Body Side Moulding Clips
 Acura # 91501-SG0-003
 15 Pcs.

1945PK



5/16" (8mm) Hole Size
 Head Diameter: 8.5mm
 Stem Length: 11mm
 White Nylon
 Body Side Moulding Clips
 Honda # 91534-SE0-000
 25 Pcs.

10790PK



Door and Bumper
 Natural Nylon
 Body Side Moulding Clips
 Honda #75305-SHJ-003
 25 Pcs.

10752PK



23/64" (9mm) Hole Size
 Top Head Diameter: 12mm
 Stem Length: 14mm
 Orange Nylon
 Cowl Vent & Radiator Support Ret.
 Honda # 90602-SAA-003
 15 Pcs.

9696PK

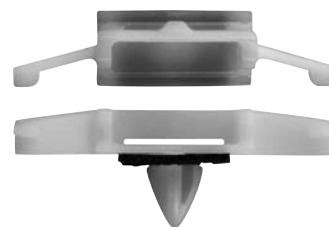

15/64" (6mm) Hole Size
 Head Dia.: 10.3mm x 43mm
 Stem Length: 10mm
 Natural Nylon With Sealer
 Drip Rail Moulding Clips
 Honda # 91528-SR4-003
 15 Pcs.

2142PK



Width: 31/32"
 Length: 61/64"
 White Nylon
 Belt Moulding Clips
 Honda # 91510-SR3-003
 10 Pcs.

9752PK

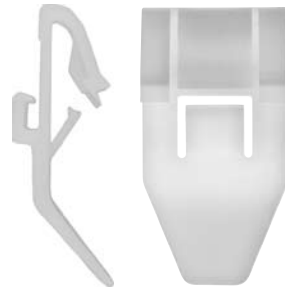

Width: 51/64"
 Length: 1 5/32"
 White Nylon
 Belt Moulding Clips
 Honda # 91527-SM4-003
 10 Pcs.

10776PK

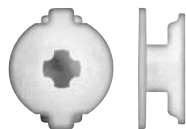

14mm Base Diameter
 Small Head: 6mm x 14mm
 Overall Height: 6mm
 Natural Nylon
 Body Side Moulding Clips
 Hyundai # 87719-3D000
 15 Pcs.

10784PK

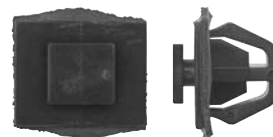

9.5mm x 12mm Hole Size
 Top Head Dia.: 8mm x 9mm
 Stem Length: 10mm
 Black Nylon With Sealer
 Body Side Moulding Clips
 Hyundai # 87756-38000
 15 Pcs.

10780PK



9.5mm x 12mm Hole Size
 Top Head Dia.: 10mm x 11mm
 Stem Length: 10mm
 Yellow Nylon With Sealer
 Rocker Moulding Clips
 Hyundai # 87758-35000
 15 Pcs.

10769PK



9.5mm x 12mm Hole Size
 Top Head Dia.: 10mm x 12mm
 Stem Length: 10mm
 White Nylon With Sealer
 Moulding Clips
 Hyundai # 87756-2E000
 15 Pcs.

10770PK



9.5mm x 12mm Hole Size
 Top Head Dia.: 16mm x 20mm
 Stem Length: 10mm
 Yellow Nylon With Sealer
 Rocker Panel Clips
 Hyundai # 87758-3D000
 15 Pcs.

10396PK

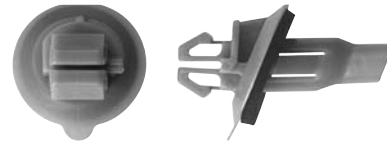

15/16" (8mm) Hole Size
 Head Diameter: 18mm
 Stem Length: 20mm
 Gray Nylon With Sealer
 Fender Moulding Clips
 Lexus # 75492-60030
 10 Pcs.

10397PK

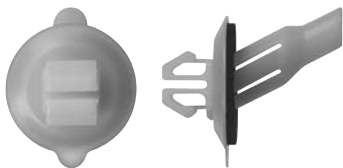

15/16" (8mm) Hole Size
 Head Diameter: 18mm
 Stem Length: 20mm
 Yellow Nylon With Sealer
 Fender Moulding Clips
 Lexus # 75394-60060
 10 Pcs.

10493PK

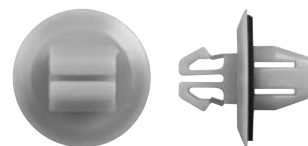

11/32" (9mm) Hole Size
 Head Diameter: 18mm
 Stem Length: 9mm
 Pink Nylon With Sealer
 Moulding Clips
 Lexus # 75395-33030
 15 Pcs.

10491PK

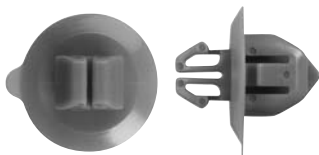

15/32" (12mm) Hole Size
 Head Diameter: 18mm
 Stem Length: 10mm
 Gray Nylon
 Rocker Panel Moulding Clips
 Lexus # 75392-6003
 15 Pcs.

10574PK



15/16" (8mm) Hole Size
 Top Head Diameter: 14mm
 Stem Length: 13mm
 Black Nylon With Sealer
 Cowl Panel Retainers
 Mazda # G043-50-742
 10 Pcs.

10789PK

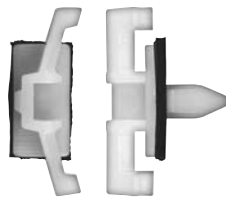

13/64" (5mm) Hole Size
 Top Head Dia.: 9mm x 25mm
 Stem Length: 10mm
 White Nylon With Sealer
 Drip Moulding Clips
 Nissan
 15 Pcs.

10742PK

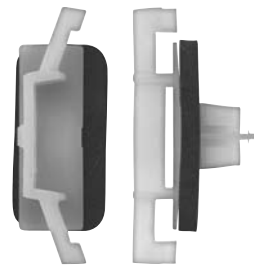

4mm x 9mm Hole Size
 Across the Top: 25mm
 Overall Length: 16mm
 White Nylon With Sealer
 Drip Moulding Clips
 Nissan
 15 Pcs.

10806PK



13/64" (5mm) Hole Size
 Overall Length: 47mm
 Stem Length: 8mm
 Gray Nylon
 Front Bumper Moulding Clips
 Toyota # 52115-48040
 10 Pcs.

10826PK

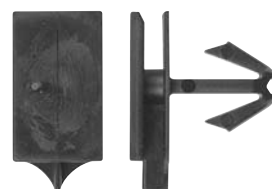

23/64" (9mm) Hole Size
 Top Head Dia.: 12mm x 20mm
 Stem Length: 15mm
 Black Nylon
 Rocker Moulding Clips
 Saturn
 15 Pcs.

10609PK



Head Diameter: 15mm
 Stem Length: 25mm
 Black Nylon
 Front Fender & Bumper Cover Pins
 Use with # 10608
 Toyota # 47749-58010
 10 Pcs.

10608PK



25mm Width 34mm Length
 Black Nylon
 Front Fender &
 Bumper Cover Clips
 Use with # 10609
 Toyota # 53879-58010
 5 Pcs.

10421PK

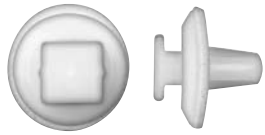

5/16" (8mm) Hole Size
 Flange Diameter: 15mm
 Stem Length: 10mm
 Natural Nylon With Sealer
 Radiator Grille Retainers
 Toyota # 62955-20020
 25 Pcs.

10635PK



23/64" (9mm) Hole Size
 Top Head Diameter: 13mm
 Stem Length: 14mm
 Black Nylon
 Rocker Panel & Scuff Plate Ret.
 Toyota # 78867-AA010
 15 Pcs.

10750PK



23/64" (9mm) Hole Size
 Top Head Dia.: 10mm x 13mm
 Stem Length: 9mm
 Yellow Nylon
 Fender Flare Retainers
 Toyota # 75867-21010
 25 Pcs.

10392PK

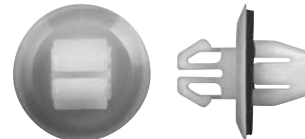

11/32" (9mm) Hole Size
 Head Diameter: 18mm
 Stem Length: 17mm
 White Nylon With Sealer
 Rocker Panel Moulding Clips
 Toyota # 90467-11063
 15 Pcs.

10112PK

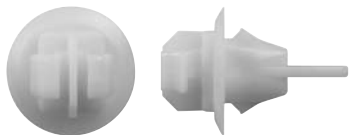

11/32" (9mm) Hole Size
 Head: 17mm Stem: 17mm
 Yellow Nylon
 Fender & Wheel Flare
 Moulding Clips
 Toyota # 90467-11100
 10 Pcs.

9946PK

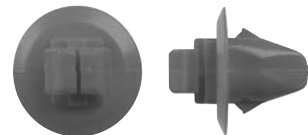

11/32" (9mm) Hole Size
 Head Diameter: 17mm
 Stem Length: 13mm
 Red Plastic
 Fender Moulding Clips
 Toyota # 90904-67037
 10 Pcs.

10113PK

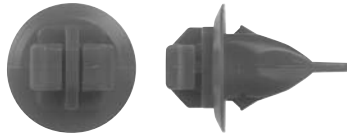

11/32" (9mm) Hole Size
 Head: 17mm Stem: 17mm
 Blue Nylon
 Fender & Wheel Flare
 Moulding Clips
 Toyota # 90904-67
 10 Pcs.

10492PK

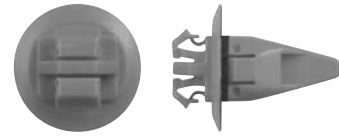

11/32" (9mm) Hole Size
 Head Diameter: 17mm
 Stem Length: 17mm
 Orange Nylon With Sealer
 Wheel Flare Moulding Clips
 Toyota # 75397-35010
 10 Pcs.

10490PK

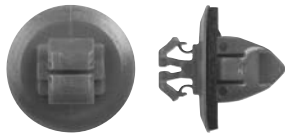

25/64" (10mm) Hole Size
 Head Diameter: 17mm
 Stem Length: 11mm
 Blue Nylon With Sealer
 Rocker Moulding Clips
 Toyota # 75495-35010
 10 Pcs.

10394PK

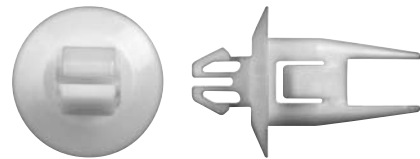

9mm x 12mm Hole Size
 Head Diameter: 20mm
 Stem Length: 20mm
 White Nylon
 Garnish Moulding Clips
 Toyota # 75498-42010
 10 Pcs.

10807PK

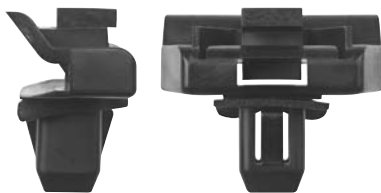

9mm Square Hole Size
 Width: 30mm
 Stem Length: 13mm
 Black Nylon With Sealer
 Front Bumper Moulding Clips
 Toyota # 52197-52010
 10 Pcs.

10936PK

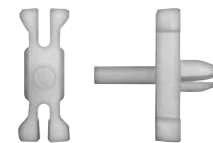

1/4" (6.5mm) Width
 Over All Length: 18mm
 White Nylon
 Body Side Moulding Clips
 V.W. # 171-853-585
 50 Pcs.

10923PK

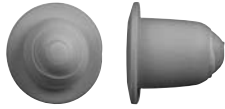

5/16" (8mm) Hole Size
 Inside Diameter: 7mm
 Stem Length: 12mm
 Green Rubber
 Moulding Grommets
 V.W. # 1H0-853-586
 50 Pcs.

10925PK

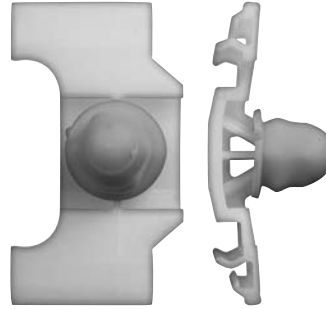

5/16" (8mm) Hole Size
 Stem Length: 11mm
 White Nylon
 Exterior Door Moulding Clips
 V.W. # 1H0-853-858A
 10 Pcs.

10921PK

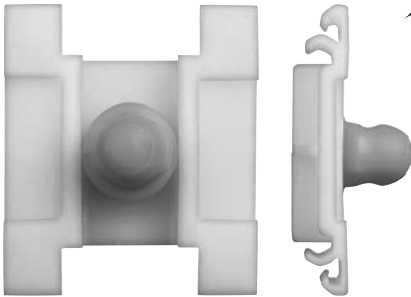

5/16" (8mm) Hole Size
 Stem Length: 10mm
 Exterior Door Trim
 Moulding Clips
 V.W. # 1H0-853-585
 10 Pcs.

10946PK

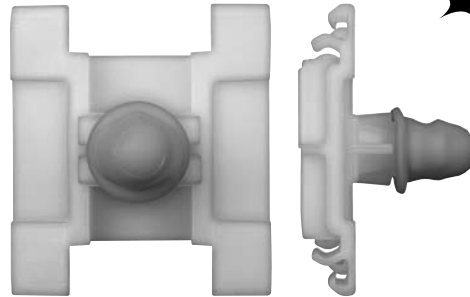

5/16" (8mm) Hole Size
 Stem Length: 19mm
 Exterior Door Trim
 Moulding Clips
 V.W. # 1H0-853-585B
 10 Pcs.

9880PK



5/16" to 1/2" Wide Mouldings
 Universal Wire Type
 Bright Zinc Finish
 Moulding Clips
 G.M.
 50 Pcs.

308PK

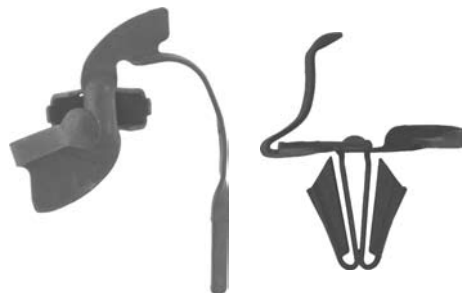

Front & Rear Door
 Universal
 Moulding Clips
 G.M. # 4759145
 50 Pcs.

315PK

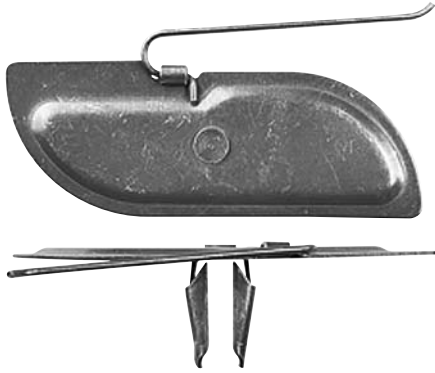

13/16" x 2 1/8" Plate Size
 Universal
 Moulding Clips
 G.M.
 25 Pcs.

2194PK

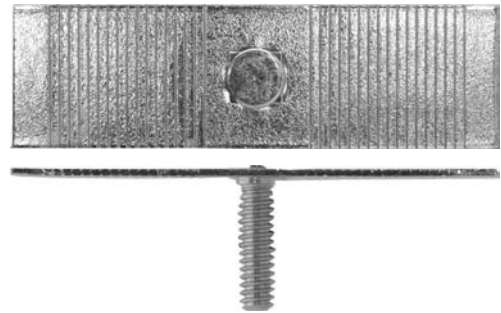

10-24 x 3/4" Screw Size
 3/4" x 2 1/2" Plate Size
 Breaks off in 1/16"
 Bright Zinc Finish
 Moulding Tee Bolts
 G.M.
 25 Pcs.

347PK



10-24 x 5/8" Screw Size
 11/32" x 23/32" Plate Size
 Universal
 Moulding Clips
 Chrysler # 1624705
 50 Pcs.

9879PK



10-24 x 3/4" Screw Size
 1/2" x 1 1/16" Plate Size
 Universal
 Moulding Clips
 Ford # 358560
 25 Pcs.

345PK

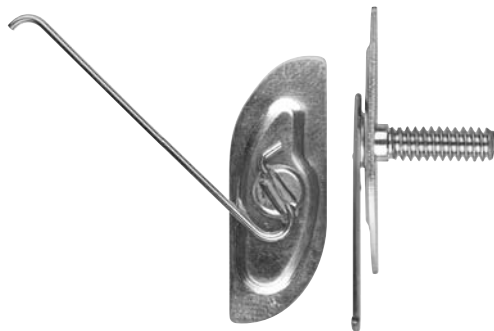

10-24 x 3/4" Screw Size
 1/2" x 1 25/64" Plate Size
 Universal
 Moulding Clips
 Chrysler # 6000705
 50 Pcs.

344PK

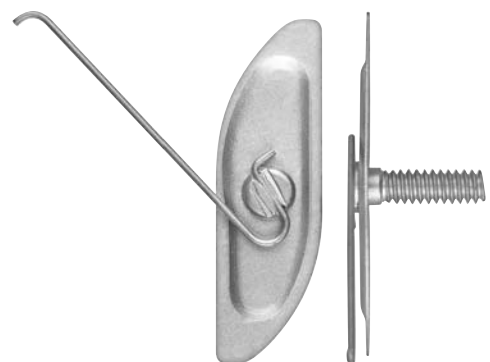

10-24 x 3/4" Screw Size
 9/16" x 1 13/16" Plate Size
 Universal Moulding Clips
 G.M. # 3744999
 50 Pcs.

589PK



5 Size
For Attaching Seat Cushions
And Cushion Springs
Metal Hog Rings
500 Pcs.

9881PK



Door & Quarter Glass
Also Door Opening
Header Bumper
G.M. # 4081765
25 Pcs.



Depressed Center
Black Plastic
Hole Plugs



Flush Type
Black Plastic
Hole Plugs

8

Part Number	Hole Size	Head Diameter	Pkg Qty
9386PK	1/2"	7/8"	100
9387PK	3/4"	1 5/32"	100

Part Number	Hole Size	Head Diameter	Pkg Qty
9812PK	1/4"	1/2"	100
1302PK	3/8"	3/4"	100
1091PK	1/2"	7/8"	100
1379PK	3/4"	1"	100

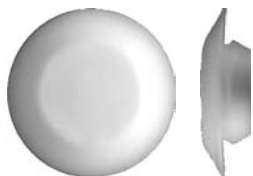

Flush Type
White Plastic
Hole Plugs



Flush Type
Black Nylon
Locking Hole Plugs

Part Number	Hole Size	Head Diameter	Pkg Qty
9827PK	1/4"	1/2"	50
9828PK	3/8"	3/4"	50
9829PK	1/2"	7/8"	50
9830PK	3/4"	1"	50

Part Number	Hole Size	Head Diameter	Pkg Qty
9844PK	3/16"	1/4"	100
2051PK	1/4"	5/16"	50
2052PK	5/16"	3/8"	50
2053PK	3/8"	15/32"	50
2225PK	1/2"	37/64"	50
9831PK	3/4"	59/64"	50

White Color Plugs are used Mostly on
White Automobiles for Paintless Dent Repair

9636PK



1/16" Thick
3/8" Slot
15/16" Round
Bright Zinc Finish
Steel Body Shims
50 Pcs.

9637PK



1/8" Thick
3/8" Slot
15/16" Round
Bright Zinc Finish
Steel Body Shims
50 Pcs.

6015PK



1/16" Thick
3/8" Slot
1 1/4" x 1 1/8"
Bright Zinc Finish
Steel Body Shims
G.M.
100 Pcs.

6016PK



1/8" Thick
3/8" Slot
1 1/4" x 1 1/8"
Bright Zinc Finish
Steel Body Shims
G.M.
100 Pcs.

9974PK

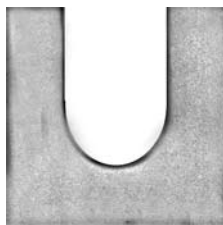

1/16" Thick
1/2" Slot
1 1/8" x 1 1/8"
Bright Zinc Finish
Steel Body Shims
G.M.
50 Pcs.

9975PK

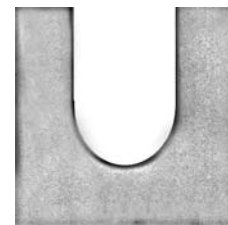

1/8" Thick
1/2" Slot
1 1/8" x 1 1/8"
Bright Zinc Finish
Steel Body Shims
G.M.
50 Pcs.

6022PK

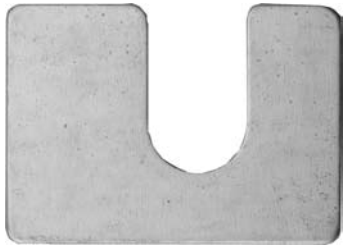

1/16" Thick
1/2" Slot
1 1/4" x 1 3/4"
Bright Zinc Finish
Steel Body Shims
G.M.
50 Pcs.

6020PK

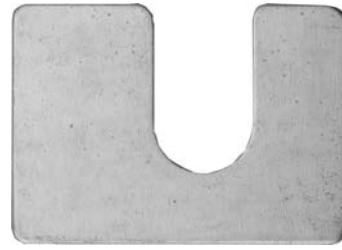

1/8" Thick
1/2" Slot
1 1/4" x 1 3/4"
Bright Zinc Finish
Steel Body Shims
G.M.
50 Pcs.

10985PK



3/16" Thick
5/8" Slot
1 3/8" x 1 1/4"
Bright Zinc Finish
Steel Body Shims
G.M.
25 Pcs.

6018PK

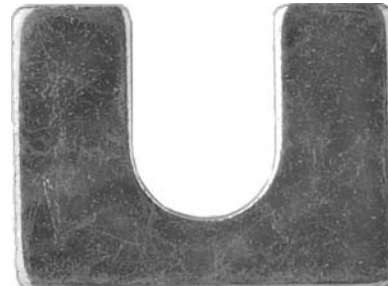

1/8" Thick
3/4" Slot
2" x 1 1/2"
Bright Zinc Finish
Steel Body Shims
G.M.
50 Pcs.

9757PK



**PLUG MUST BE
REPLACED EACH
TIME THE OIL
IS CHANGED**

1/2" Hole
Replaces Standard Drain Plugs
When Threads are Stripped in Pan
Black Rubber Universal Drain Plug
G.M.
1 Pc.

9758PK

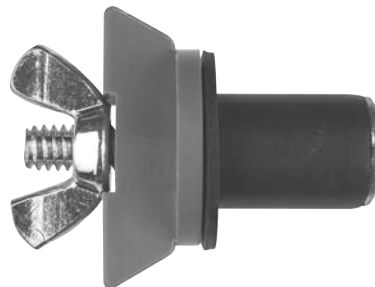

**PLUG MUST BE
REPLACED EACH
TIME THE OIL
IS CHANGED**

5/8" Hole
Replaces Standard Drain Plugs
When Threads are Stripped in Pan
Black Rubber Universal Drain Plug
G.M.
1 Pc.

10475PK

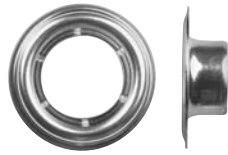

Size # 2
3/8" I.D. 3/4" O.D.
Self-Piercing
Nickle on Brass
Grommets & Washers
144 Pcs.

9756



1/8" Thick 1/2" Wide
50 Feet Long
Black Adhesive
Sponge Weatherstrip
G.M.
Sold per Roll

9823PK



Used for scraping windshields
with special coatings;
prevents windshield
coating damage
Plastic Single Edge
Razor Blades
25 Pcs.

10690

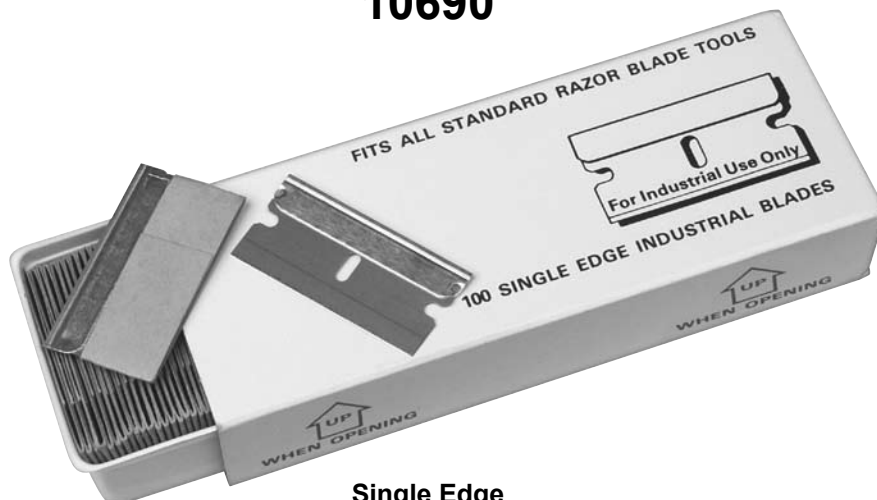

Single Edge
Industrial Razor Blades
100 Pcs.

Hose Clamps



**5/16" and 1/2" Band Width
Stainless Steel Band & Housing
Worm Gear Hose Clamps**

Part Number	SAE Size	Clamp Range	Hose Inside Diameter	Band Width	Screw Hex Size
10889PK	# 4 Mini	1/4" - 5/8"	1/8" - 5/16"	5/16"	1/4"
11408PK	# 5 Mini	1/4" - 11/16"	1/8" - 3/8"	5/16"	1/4"
10890PK	# 6 Mini	5/16" - 7/8"	1/4" - 7/16"	5/16"	1/4"
10891PK	# 6 Standard	3/8" - 7/8"	5/16" - 3/8"	1/2"	5/16"
10892PK	# 8 Standard	7/16" - 1"	5/16" - 1/2"	1/2"	5/16"
10893PK	# 10 Standard	1/2" - 1 1/16"	3/8" - 5/8"	1/2"	5/16"
10894PK	# 12 Standard	1/2" - 1 1/4"	3/8" - 3/4"	1/2"	5/16"
10895PK	# 16 Standard	11/16" - 1 1/2"	3/4" - 7/8"	1/2"	5/16"
10896PK	# 20 Standard	3/4" - 1 3/4"	3/4" - 1 1/8"	1/2"	5/16"
10897PK	# 24 Standard	1" - 2"	7/8" - 1 3/8"	1/2"	5/16"
10898PK	# 28 Standard	1 1/4" - 2 1/4"	1 1/4" - 1 5/8"	1/2"	5/16"
10899PK	# 32 Standard	1 1/2" - 2 1/2"	1 1/2" - 1 7/8"	1/2"	5/16"
10900PK	# 36 Standard	1 3/4" - 2 3/4"	1 3/4" - 2"	1/2"	5/16"
10901PK	# 40 Standard	2" - 3"	2" - 2 1/4"	1/2"	5/16"
10902PK	# 44 Standard	2 1/4" - 3 1/4"	2 1/4" - 2 1/2"	1/2"	5/16"
10903PK	# 48 Standard	2 1/2" - 3 1/2"	2 1/2" - 4"	1/2"	5/16"
10904PK	# 52 Standard	2 3/4" - 3 3/4"	2 3/4" - 3"	1/2"	5/16"
10905PK	# 56 Standard	3" - 4"	3" - 3 1/2"	1/2"	5/16"
10906PK	# 60 Standard	3 1/4" - 4 1/4"	3 1/4" - 3 1/2"	1/2"	5/16"
10907PK	# 64 Standard	2 1/2" - 4 1/2"	2 1/2" - 4"	1/2"	5/16"
10908PK	# 72 Standard	3" - 5"	3" - 4 1/2"	1/2"	5/16"
10909PK	# 80 Standard	3 1/2" - 5 1/2"	3 1/2" - 5"	1/2"	5/16"
10910PK	# 88 Standard	4" - 6"	4" - 5 1/2"	1/2"	5/16"
10911PK	# 96 Standard	4 1/2" - 6 1/2"	4 1/2" - 6"	1/2"	5/16"
10912PK	# 104 Standard	5" - 7"	5" - 6 1/2"	1/2"	5/16"

Hose or Clamp Dimensional Sizing Chart

Diameter
1/16" Increments

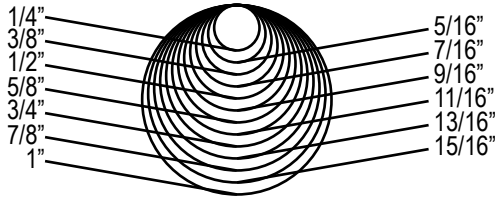

Mini
Hose Clamps

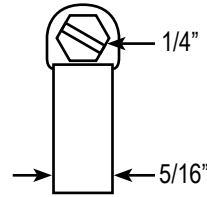

Standard
Hose Clamps

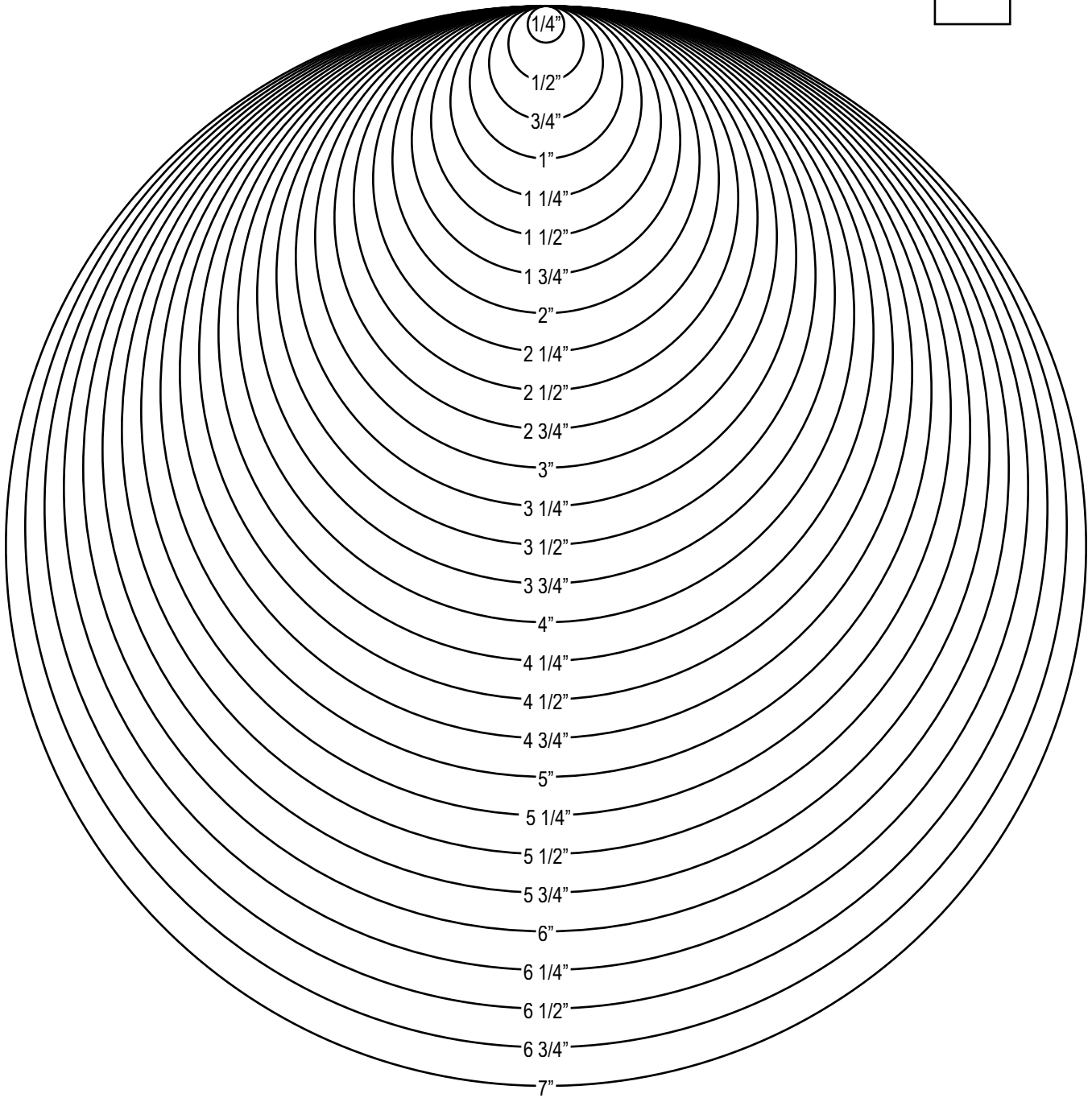
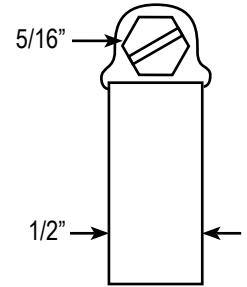

A collection of various metal rivets and bolts scattered across the page. The items include different sizes and types of rivets, some with hexagonal heads, some with rounded heads, and some with threaded shafts. The rivets are shown in various orientations, some standing upright and some lying horizontally. The background is white, and the rivets are in shades of gray.

Rivets

1374PK



5/32" (4mm) Hole Size
 Grip Range: 1/4" - 13/32"
 Rectangle Flange
 Black Nylon
 Blind Rivets
 Ford # N804583S
 25 Pcs.

5768PK



3/16" (5mm) Hole Size
 Grip Range: 5/32" - 1/4"
 Flange Diameter: 11/32"
 Black Nylon
 Blind Rivets
 Chrysler # 6502689
 25 Pcs.

10565PK



13/64" (5.15mm) Hole Size
 Grip Range: 1/8" - 5/32"
 Flange Diameter: 11/32"
 Black Nylon
 Blind Rivets
 G.M. # 20465395
 25 Pcs.

9053PK



13/64" (5.15mm) Hole Size
 Grip Range: 1/16" - 11/64"
 Flange Diameter: 15/32"
 Black Nylon
 Blind Rivets
 G.M. # 20423647
 25 Pcs.

5769PK



13/64" (5.15mm) Hole Size
 Grip Range: 1/8" - 15/64"
 Flange Diameter: 15/32"
 Black Nylon
 Blind Rivets
 G.M. # 20432975
 25 Pcs.

1195PK



13/64" (5.15mm) Hole Size
 Grip Range: 15/64" - 25/64"
 Flange Diameter: 15/32"
 Black Nylon
 Blind Rivets
 Chrysler # 6500898
 25 Pcs.

2080PK



15/64" (5.95mm) Hole Size
 Grip Range: 11/64" - 11/32"
 Flange Diameter: 1/2"
 Black Nylon
 Blind Rivets
 G.M. # 25524005
 25 Pcs.

1390PK



1/4" (6.35mm) Hole Size
 Grip Range: 5/32" - 13/32"
 Flange Diameter: 1/2"
 Black Nylon
 Blind Rivets
 G.M. # 20452072
 25 Pcs.

10560PK



1/4" (6.35mm) Hole Size
 Grip Range: 5/32" - 9/32"
 Flange Diameter: 1/2"
 Black Nylon
 Blind Rivets
 Ford # N804472-S
 25 Pcs.

9054PK



17/64" (6.74mm) Hole Size
 Grip Range: 3/32" - 3/16"
 Flange Diameter: 1/2"
 Black Nylon
 Blind Rivets
 G.M. # 20421672
 25 Pcs.

9854PK



15/64" (5.95mm) Hole Size
 Grip Range: 5/32" - 5/16"
 Flange Diameter: 5/8"
 Black Nylon
 Blind Rivets
 G.M. # 10036503
 25 Pcs.

10562PK



1/4" (6.35mm) Hole Size
 Grip Range: 5/32" - 1/4"
 Flange Diameter: 21/32"
 Black Nylon
 Blind Rivets
 25 Pcs.

10630PK



1/4" (6.35mm) Hole Size
 Panel Range: 5/32" - 3/8"
 Flange Diameter: 21/32"
 Black Nylon
 Blind Rivets
 G.M. # 15614746
 25 Pcs.

10561PK



1/4" (6.35mm) Hole Size
 Panel Range: 5/32" - 3/8"
 Flange Diameter: 11/16"
 Gray Nylon
 Blind Rivets
 AMC # 8934-201-835
 25 Pcs.

5770PK



1/4" (6.35mm) Hole Size
 Grip Range: 5/32" - 13/32"
 Flange Diameter: 21/32"
 Black Nylon
 Blind Rivets
 G.M. # 14063981
 25 Pcs.

9128PK



1/4" (6.35mm) Hole Size
 Grip Range: 5/16" - 15/32"
 Flange Diameter: 21/32"
 Black Nylon
 Blind Rivets
 Ford # N804675S
 25 Pcs.

5775PK



17/64" (6.74mm) Hole Size
 Grip Range: 3/32" - 3/16"
 Flange Diameter: 23/32"
 Black Nylon
 Blind Rivets
 G.M. # 20433026
 25 Pcs.

1467PK



9/32" (7.14mm) Hole Size
 Grip Range: 3/32" - 15/64"
 Flange Diameter: 23/32"
 Black Nylon
 Blind Rivets
 G.M. # 12337915
 25 Pcs.

10563PK



1/4" (6.35mm) Hole Size
 Grip Range: 1/32" - 11/64"
 Flange Diameter: 21/32"
 Black Nylon
 Blind Rivets
 Chrysler # 4630088
 25 Pcs.

10564PK

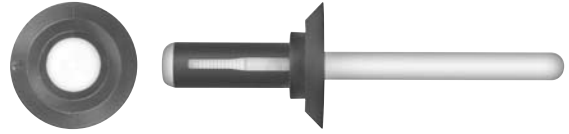

1/4" (6.35mm) Hole Size
 Grip Range: 1/32" - 3/16"
 Flange Diameter: 21/32"
 Black Nylon
 Blind Rivets
 Chrysler # 4630660
 25 Pcs.

9893PK



1/8" (3.1mm) Hole Size
 Grip Range: 3/16" - 1/4"
 Special Small Flange Dia.: 3/16"
 Stainless Steel Rivet Steel Mandrel
 Moulding Stud Rivets
 Ford # 383229-S
 100 Pcs.

9243PK



1/8" (3.1mm) Hole Size
 Grip Range: 3/16" - 1/4"
 Flange Diameter: 1/4"
 Black Finish All Aluminum
 Pop Rivets
 Industrial # 44
 100 Pcs.

9454PK



1/8" (3.1mm) Hole Size
 Grip Range: 3/16" - 1/4"
 Black Finish All Aluminum
 Luggage Rack Sealing Strip
 Closed End Pop Rivets
 Ford # N803933-S101
 50 Pcs.

9118PK



1/8" (3.1mm) Hole Size
 Grip Range: 1/16" - 1/8"
 Flange Diameter: 3/8"
 Black Alum. Rivet Steel Mandrel
 Windshield Side Rail Rivets
 Replaces Ford # N805759-S100
 50 Pcs.

1799PK



1/8" (3.1mm) Hole Size
 Grip Range: 1/8" - 3/16"
 Flange Diameter: 3/8"
 Black Alum. Rivet Steel Mandrel
 Pop Rivets
 50 Pcs.

1607PK



5/32" (3.9mm) Hole Size
 Grip Range: 1/8" - 3/16"
 Flange Dia.: 5/16" Countersunk Hd
 All Aluminum Closed End
 Swivel Emblem Lock Rivets
 G.M. # 9432137
 25 Pcs.

9277PK



5/32" (3.9mm) Hole Size
 Grip Range: 1/4" - 3/8"
 Flange Diameter: 15/32"
 Black Alum. Rivet Steel Mandrel
 Wheel Opening Mldg. Pop Rivets
 V.W. # N900-845-01
 25 Pcs.

10765PK



4mm Hole Size
 Grip Range: .8mm - 1.5mm
 Flange Diameter: 10mm
 Alum. Rivet Steel Mandrel
 Nylon Capped Pop Rivets
 Toyota # 75547-51021
 15 Pcs.

10507PK



4mm Hole Size
 Grip Range: 1.2mm - 3.4mm
 Flange Diameter: 6mm
 Alum. Rivet Steel Mandrel
 Nylon Capped Pop Rivets
 Lexus # 90269-04051
 10 Pcs.

10508PK



4mm Hole Size
 Grip Range: 1.2mm - 4mm
 Flange Diameter: 9mm
 Alum. Rivet Steel Mandrel
 Nylon Capped Pop Rivets
 Toyota # 90269-04006
 10 Pcs.

10509PK



4mm Hole Size
 Grip Range: 1mm - 4.8mm
 Flange Diameter: 9mm
 Alum. Rivet Steel Mandrel
 Nylon Capped Pop Rivets
 Toyota # 90269-04050
 10 Pcs.

10458PK



4mm Hole Size
 Grip Range: 4mm - 8mm
 Flange Diameter: 9mm
 Alum. Rivet Steel Mandrel
 Nylon Capped Pop Rivets
 Toyota # 90269-04050
 15 Pcs.

1609PK



3/16" (4.7mm) Hole Size
 Grip Range: 5/64" - 15/64"
 Flange Diameter: 7/16"
 Wheel House Mldg. & Univ.
 Black Alum. Split-Type Rivets
 Ford # N805592-S100
 25 Pcs.

9718PK



3/16" (4.7mm) Hole Size
 Grip Range: 1/16" - 17/64"
 Flange Diameter: 3/8"
 Black All Steel Rivet
 Outside Door Handle Rivets
 G.M. # 22641917
 25 Pcs.

9278PK



3/16" (4.7mm) Hole Size
 Grip Range: 3/64" - 11/32"
 Flange Diameter: 3/8"
 Moulding Attachment
 Black Alum. Split-Type Rivets
 G.M. # 10125439
 25 Pcs.

2287PK

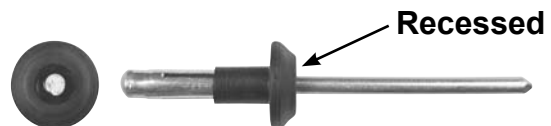

5/32" (4mm) Hole Size
 Grip Range: 3mm - 8.5mm
 Flange Diameter: 12mm
 Alum. Rivet Black Poly.Coated Flange
 Bumper & Wheel Housing Rivets
 Volvo # 979878-6
 15 Pcs.

9453PK



3/16" (4.7mm) Hole Size
 Grip Range: 3/8" - 1/2"
 Flange Diameter: 3/8"
 Black All Aluminum
 Closed End Pop Rivets
 Ford # 390428-S100
 25 Pcs.

4005PK



3/16" (4.7mm) Hole Size
 Grip Range: 3/8" - 1/2"
 Flange Diameter: 9/16"
 All Aluminum
 Black Grille & Fascia Rivets
 Ford # 388664-S100
 25 Pcs.

9618PK



3/16" (4.7mm) Hole Size
 Grip Range: 11/16" - 13/16"
 Flange Diameter: 3/4"
 Grille & Bumper
 All Aluminum Pop Rivets
 Ford # N807168-S
 25 Pcs.

10764PK

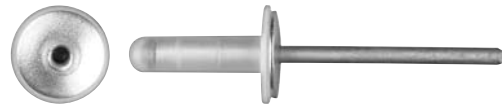

5mm Hole Size
 Grip Range: 4mm - 7mm
 Flange Diameter: 13mm
 Alum. Rivet Steel Mandrel
 Nylon Capped Pop Rivets
 Lexus # 90269-05065
 10 Pcs.

10510PK



5mm Hole Size
 Grip Range: 3mm - 8mm
 Flange Diameter: 14mm
 Alum. Rivet Steel Mandrel
 Nylon Capped Pop Rivets
 Toyota # 90269-05054
 10 Pcs.

10459PK



6mm Hole Size
 Grip Range: 1.6mm - 6.35mm
 Flange Diameter: 13.5mm
 Alum. Rivet Steel Mandrel
 Nylon Capped Pop Rivets
 Toyota # 90269-06013
 15 Pcs.

9644PK



1/4" (6.3mm) Hole Size
 Grip Range: 3/64" - 5/64"
 Flange: 19/32" Shoulder Dia.:13/32"
 All Steel Bright Zinc Finish
 Headlight Retainer Rivets
 G.M. #15022087
 25 Pcs.

4009PK



1/4" (6.3mm) Hole Size
 Grip Range: 3/32" - 1/8"
 Flange Diameter: 1/2"
 Aluminum Rivet Steel Mandrel
 Black Outside Door Handle Rivets
 Ford # 388047-S102
 25 Pcs.

4007PK



1/4" (6.3mm) Hole Size
 Grip Range: 1/32" - 9/64"
 Flange Diameter: 1/2"
 Aluminum Rivet Steel Mandrel
 Window Regulator Peel Rivets
 G.M. # 9436175
 25 Pcs.

9902PK



1/4" (6.3mm) Hole Size
 Grip Range: 9/64" - 3/16"
 Flange Diameter: 1/2"
 Aluminum Rivet Steel Mandrel
 Window Regulator Peel Rivets
 G.M. # 9437486
 25 Pcs.

1415PK

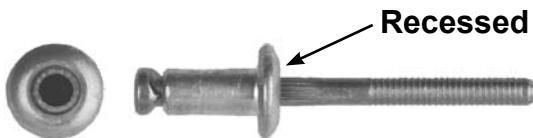

1/4" (6.3mm) Hole Size
 Grip Range: 1/32" - 7/32"
 Flange Diameter: 1/2"
 Aluminum Rivet Steel Mandrel
 Outside Door Handle Rivets
 Ford # 388047-S100
 25 Pcs.

4014PK

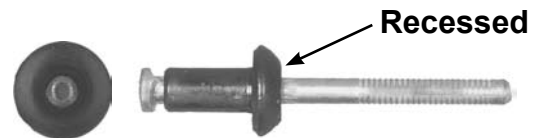

1/4" (6.3mm) Hole Size
 Grip Range: 1/32" - 7/32"
 Flange Diameter: 1/2"
 Aluminum Rivet Steel Mandrel
 Black Door Handle Rivets
 Ford # W525172-S417
 15 Pcs.

9885PK



1/4" (6.3mm) Hole Size
 Grip Range: 1/8" - 1/4"
 Flange Diameter: 1/2"
 All Steel Yellow Zinc Dichromate
 Front Bumper Assembly Rivets
 Ford # 372820-S36
 25 Pcs.

4002PK



1/4" (6.3mm) Hole Size
 Grip Range: 1/8" - 1/4"
 Flange Diameter: 3/4"
 Black Rivet All Steel
 Bumper Assembly Rivets
 Ford # 388442-S100
 25 Pcs.

9989PK



1/4" (6.3mm) Hole Size
 Grip Range: 1/8" - 21/64"
 Flange Diameter: 3/4"
 Black Alum. Rivet Steel Mandrel
 Door Lock Actuator Rivets
 Ford # N808689-S417
 10 Pcs.

4015PK

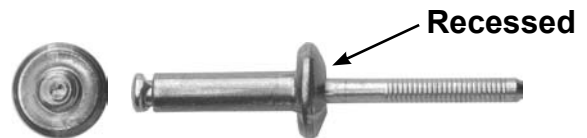

1/4" (6.3mm) Hole Size
 Grip Range: 25/64" - 21/32"
 Flange Diameter: 5/8"
 Aluminum Rivet Steel Mandrel
 Door Glass Peel Rivets
 Ford # W525175-S
 15 Pcs.

10828PK



1/4" (6.3mm) Hole Size
 Grip Range: 1/4" - 9/16"
 Flange Diameter: 3/4"
 All Steel
 Assembly Type Pop Rivets
 Ford # N808229-S100
 25 Pcs.

1951PK



1/4" (6.3mm) Hole Size
 Grip Range: 3/16" - 3/8"
 Flange Diameter: 11/16"
 Black Alum. Split Type Rivets
 Bumper Cover
 Ford # N806860-S100
 15 Pcs.

4008PK



1/4" (6.3mm) Hole Size
 Grip Range: 33/64" - 19/32"
 Flange Diameter: 1/2"
 Aluminum Rivet Steel Mandrel
 Glass Stop Peel Rivets
 G.M. # 9437938
 25 Pcs.

10605PK



1/8" Rivet Size
 3/8" Outside Diameter
 Bright Zinc Finish
 Rivet Back-Up Washers
 100 Pcs.

10606PK



3/16" Rivet Size
 1/2" Outside Diameter
 Bright Zinc Finish
 Rivet Back-Up Washers
 100 Pcs.

4011PK



Some Installations
 may require
 5/8" Washer
 (Some provided)

Remove & Resetting Door Glass
 Made Easy, Fits Most:
 Ford, G.M., Chry. Products
 Black Zytel Nylon
 Door Glass Replacement Kits
 50 Pcs.

All Aluminum Blind Rivets

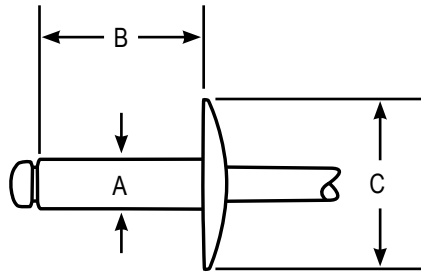

Part Number	Industrial Number	A Rivet Diameter	B Rivet Length	C Flange Diameter	Flange Type	Grip Range	Material Type Rivet/Mandrel	Pkg Qty
10585PK	32	3/32"	13/64"	3/16"	Dome	To - 1/8"	Alum/Alum	100
10586PK	34	3/32"	11/32"	3/16"	Dome	1/8" - 1/4"	Alum/Alum	100
10587PK	41	1/8"	11/64"	1/4"	Dome	1/32" - 1/16"	Alum/Alum	100
1888PK	42	1/8"	15/64"	1/4"	Dome	1/16" - 1/8"	Alum/Alum	100
10588PK	42L	1/8"	15/64"	3/8"	Lg Flange	1/16" - 1/8"	Alum/Alum	100
10589PK	43	1/8"	19/64"	1/4"	Dome	1/8" - 3/16"	Alum/Alum	100
1889PK	44	1/8"	23/64"	1/4"	Dome	3/16" - 1/4"	Alum/Alum	100
9596PK	44L	1/8"	23/64"	3/8"	Lg Flange	3/16" - 1/4"	Alum/Alum	100
10590PK	45	1/8"	27/64"	1/4"	Dome	1/4" - 5/16"	Alum/Alum	100
1890PK	46	1/8"	31/64"	1/4"	Dome	5/16" - 3/8"	Alum/Alum	100
10124PK	46L	1/8"	31/64"	3/8"	Lg Flange	5/16" - 3/8"	Alum/Alum	100
1891PK	48	1/8"	39/64"	1/4"	Dome	3/8" - 1/2"	Alum/Alum	100
10592PK	52	5/32"	1/4"	5/16"	Dome	1/16" - 1/8"	Alum/Alum	100
10593PK	53	5/32"	5/16"	5/16"	Dome	1/8" - 3/16"	Alum/Alum	100
9572PK	54	5/32"	3/8"	5/16"	Dome	3/16" - 1/4"	Alum/Alum	100
10594PK	54L	5/32"	3/8"	15/32"	Lg Flange	3/16" - 1/4"	Alum/Alum	50
10595PK	56	5/32"	1/2"	5/16"	Dome	1/4" - 3/8"	Alum/Alum	100
10596PK	58	5/32"	5/8"	5/16"	Dome	3/8" - 1/2"	Alum/Alum	50
1899PK	62	3/16"	9/32"	3/8"	Dome	1/16" - 1/8"	Alum/Alum	100
1900PK	64	3/16"	13/32"	3/8"	Dome	1/8" - 1/4"	Alum/Alum	100
1903PK	64L	3/16"	13/32"	5/8"	Lg Flange	1/8" - 1/4"	Alum/Alum	50
1901PK	66	3/16"	17/32"	3/8"	Dome	1/4" - 3/8"	Alum/Alum	100
1904PK	66L	3/16"	17/32"	5/8"	Lg Flange	1/4" - 3/8"	Alum/Alum	100
1902PK	68	3/16"	21/32"	3/8"	Dome	3/8" - 1/2"	Alum/Alum	100
1905PK	68L	3/16"	21/32"	5/8"	Lg Flange	3/8" - 1/2"	Alum/Alum	50
10597PK	610	3/16"	25/32"	3/8"	Dome	1/2" - 5/8"	Alum/Alum	100
10598PK	610L	3/16"	25/32"	5/8"	Lg Flange	1/2" - 5/8"	Alum/Alum	25
10599PK	612	3/16"	29/32"	3/8"	Dome	5/8" - 3/4"	Alum/Alum	50
10600PK	84	1/4"	29/64"	1/2"	Dome	3/16" - 1/4"	Alum/Alum	25
10601PK	86	1/4"	37/64"	1/2"	Dome	1/4" - 3/8"	Alum/Alum	25
10602PK	88	1/4"	11/16"	1/2"	Dome	3/8" - 1/2"	Alum/Alum	25
10603PK	810	1/4"	53/64"	1/2"	Dome	1/2" - 5/8"	Alum/Alum	25
10604PK	812	1/4"	15/16"	1/2"	Dome	5/8" - 3/4"	Alum/Alum	25

All Steel Blind Rivets

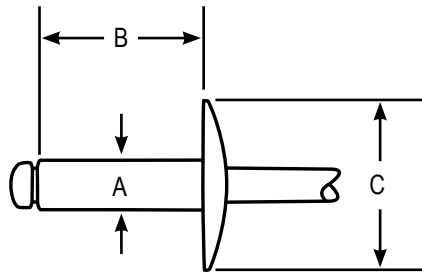

Part Number	Industrial Number	A Rivet Diameter	B Rivet Length	C Flange Diameter	Flange Type	Grip Range	Material Type Rivet/Mandrel	Pkg Qty
11078PK	32	3/32"	13/64"	3/16"	Dome	To - 1/8"	Steel/Steel	100
11079PK	34	3/32"	11/32"	3/16"	Dome	1/8" - 1/4"	Steel/Steel	100
11080PK	41	1/8"	11/64"	1/4"	Dome	1/32" - 1/16"	Steel/Steel	100
11081PK	42	1/8"	15/64"	1/4"	Dome	1/16" - 1/8"	Steel/Steel	100
11103PK	42L	1/8"	15/64"	3/8"	Lg Flange	1/16" - 1/8"	Steel/Steel	100
11082PK	43	1/8"	19/64"	1/4"	Dome	1/8" - 3/16"	Steel/Steel	100
11083PK	44	1/8"	23/64"	1/4"	Dome	3/16" - 1/4"	Steel/Steel	100
11104PK	44L	1/8"	23/64"	3/8"	Lg Flange	3/16" - 1/4"	Steel/Steel	100
11084PK	45	1/8"	27/64"	1/4"	Dome	1/4" - 5/16"	Steel/Steel	100
11085PK	46	1/8"	31/64"	1/4"	Dome	5/16" - 3/8"	Steel/Steel	100
11105PK	46L	1/8"	31/64"	3/8"	Lg Flange	5/16" - 3/8"	Steel/Steel	100
11086PK	48	1/8"	39/64"	1/4"	Dome	3/8" - 1/2"	Steel/Steel	100
11087PK	52	5/32"	1/4"	5/16"	Dome	1/16" - 1/8"	Steel/Steel	100
11088PK	53	5/32"	5/16"	5/16"	Dome	1/8" - 3/16"	Steel/Steel	100
11089PK	54	5/32"	3/8"	5/16"	Dome	3/16" - 1/4"	Steel/Steel	100
11106PK	54L	5/32"	3/8"	15/32"	Lg Flange	3/16" - 1/4"	Steel/Steel	50
11090PK	56	5/32"	1/2"	5/16"	Dome	1/4" - 3/8"	Steel/Steel	100
11091PK	58	5/32"	5/8"	5/16"	Dome	3/8" - 1/2"	Steel/Steel	50
11092PK	62	3/16"	9/32"	3/8"	Dome	1/16" - 1/8"	Steel/Steel	100
1123PK	64	3/16"	13/32"	3/8"	Dome	1/8" - 1/4"	Steel/Steel	100
11107PK	64L	3/16"	13/32"	5/8"	Lg Flange	1/8" - 1/4"	Steel/Steel	50
11094PK	66	3/16"	17/32"	3/8"	Dome	1/4" - 3/8"	Steel/Steel	100
11108PK	66L	3/16"	17/32"	5/8"	Lg Flange	1/4" - 3/8"	Steel/Steel	100
11095PK	68	3/16"	21/32"	3/8"	Dome	3/8" - 1/2"	Steel/Steel	100
11109PK	68L	3/16"	21/32"	5/8"	Lg Flange	3/8" - 1/2"	Steel/Steel	50
11096PK	610	3/16"	25/32"	3/8"	Dome	1/2" - 5/8"	Steel/Steel	100
11110PK	610L	3/16"	25/32"	5/8"	Lg Flange	1/2" - 5/8"	Steel/Steel	25
11097PK	612	3/16"	29/32"	3/8"	Dome	5/8" - 3/4"	Steel/Steel	50
11098PK	84	1/4"	29/64"	1/2"	Dome	3/16" - 1/4"	Steel/Steel	25
11099PK	86	1/4"	37/64"	1/2"	Dome	1/4" - 3/8"	Steel/Steel	25
11100PK	88	1/4"	11/16"	1/2"	Dome	3/8" - 1/2"	Steel/Steel	25
11101PK	810	1/4"	53/64"	1/2"	Dome	1/2" - 5/8"	Steel/Steel	25
11102PK	812	1/4"	15/16"	1/2"	Dome	5/8" - 3/4"	Steel/Steel	25

Aluminum/Steel Blind Rivets

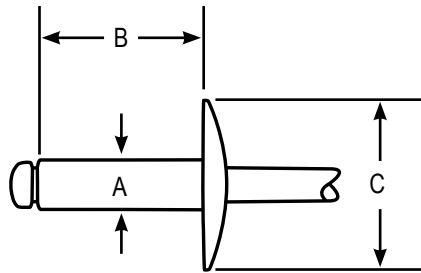

Part Number	Industrial Number	A Rivet Diameter	B Rivet Length	C Flange Diameter	Flange Type	Grip Range	Material Type Rivet/Mandrel	Pkg Qty
11045PK	32	3/32"	13/64"	3/16"	Dome	To - 1/8"	Alum/Steel	100
11046PK	34	3/32"	11/32"	3/16"	Dome	1/8" - 1/4"	Alum/Steel	100
11047PK	41	1/8"	11/64"	1/4"	Dome	1/32" - 1/16"	Alum/Steel	100
11048PK	42	1/8"	15/64"	1/4"	Dome	1/16" - 1/8"	Alum/Steel	100
11070PK	42L	1/8"	15/64"	3/8"	Lg Flange	1/16" - 1/8"	Alum/Steel	100
11049PK	43	1/8"	19/64"	1/4"	Dome	1/8" - 3/16"	Alum/Steel	100
11050PK	44	1/8"	23/64"	1/4"	Dome	3/16" - 1/4"	Alum/Steel	100
11071PK	44L	1/8"	23/64"	3/8"	Lg Flange	3/16" - 1/4"	Alum/Steel	100
11051PK	45	1/8"	27/64"	1/4"	Dome	1/4" - 5/16"	Alum/Steel	100
11052PK	46	1/8"	31/64"	1/4"	Dome	5/16" - 3/8"	Alum/Steel	100
11072PK	46L	1/8"	31/64"	3/8"	Lg Flange	5/16" - 3/8"	Alum/Steel	100
11053PK	48	1/8"	39/64"	1/4"	Dome	3/8" - 1/2"	Alum/Steel	100
11054PK	52	5/32"	1/4"	5/16"	Dome	1/16" - 1/8"	Alum/Steel	100
11055PK	53	5/32"	5/16"	5/16"	Dome	1/8" - 3/16"	Alum/Steel	100
11056PK	54	5/32"	3/8"	5/16"	Dome	3/16" - 1/4"	Alum/Steel	100
11073PK	54L	5/32"	3/8"	15/32"	Lg Flange	3/16" - 1/4"	Alum/Steel	50
11057PK	56	5/32"	1/2"	5/16"	Dome	1/4" - 3/8"	Alum/Steel	100
11058PK	58	5/32"	5/8"	5/16"	Dome	3/8" - 1/2"	Alum/Steel	50
11059PK	62	3/16"	9/32"	3/8"	Dome	1/16" - 1/8"	Alum/Steel	100
11060PK	64	3/16"	13/32"	3/8"	Dome	1/8" - 1/4"	Alum/Steel	100
11074PK	64L	3/16"	13/32"	5/8"	Lg Flange	1/8" - 1/4"	Alum/Steel	50
11061PK	66	3/16"	17/32"	3/8"	Dome	1/4" - 3/8"	Alum/Steel	100
11075PK	66L	3/16"	17/32"	5/8"	Lg Flange	1/4" - 3/8"	Alum/Steel	100
11062PK	68	3/16"	21/32"	3/8"	Dome	3/8" - 1/2"	Alum/Steel	100
11076PK	68L	3/16"	21/32"	5/8"	Lg Flange	3/8" - 1/2"	Alum/Steel	50
11063PK	610	3/16"	25/32"	3/8"	Dome	1/2" - 5/8"	Alum/Steel	100
11077PK	610L	3/16"	25/32"	5/8"	Lg Flange	1/2" - 5/8"	Alum/Steel	25
11064PK	612	3/16"	29/32"	3/8"	Dome	5/8" - 3/4"	Alum/Steel	50
11065PK	84	1/4"	29/64"	1/2"	Dome	3/16" - 1/4"	Alum/Steel	25
11066PK	86	1/4"	37/64"	1/2"	Dome	1/4" - 3/8"	Alum/Steel	25
11067PK	88	1/4"	11/16"	1/2"	Dome	3/8" - 1/2"	Alum/Steel	25
11068PK	810	1/4"	53/64"	1/2"	Dome	1/2" - 5/8"	Alum/Steel	25
11069PK	812	1/4"	15/16"	1/2"	Dome	5/8" - 3/4"	Alum/Steel	25

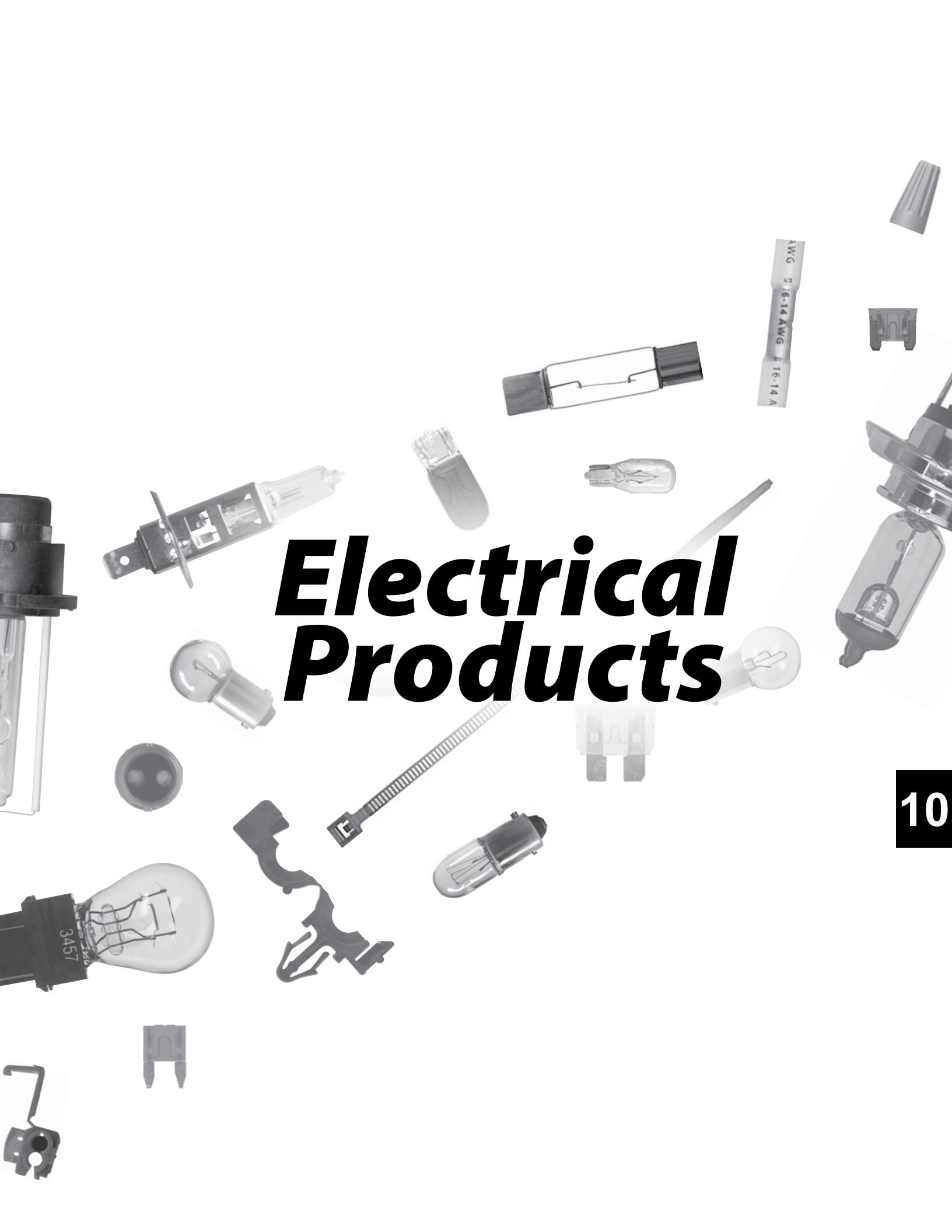

Electrical Products

9690PK

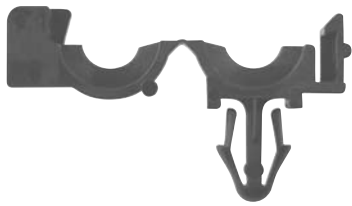

1/4" I.D." 3/8" O.D.
Black Nylon
Wire Loom Routing Clips
G.M. # 12015631
15 Pcs.

1237PK



11/32" I.D." 1/2" O.D.
Black Nylon
Wire Loom Routing Clips
G.M. # 8911473
25 Pcs.

1238PK



13/32" I.D." 19/32" O.D.
Black Nylon
Wire Loom Routing Clips
G.M. # 8911497
25 Pcs.

1239PK



1/2" I.D." 11/16" O.D.
Black Nylon
Wire Loom Routing Clips
G.M. # 8911472
25 Pcs.

1240PK



3/4" I.D." 1" O.D.
Black Nylon
Wire Loom Routing Clips
G.M. # 8917320
25 Pcs.

10

UV Black Nylon Cable Ties



Part Number	Length	Bundle Diameter	Tensile Strength	Pkg Qty
1700PK	4"	up to 7/8"	18 LBS.	100
1702PK	7"	up to 1 3/4"	50 LBS.	100
1703PK	11"	up to 3"	50 LBS.	100
1704PK	14"	up to 4"	50 LBS.	100
9724PK	14"(HD)	up to 4"	120 LBS.	100

9279PK



140mm Long
 Max. Bundle Diameter: 30mm
 Universal Use
 Black Nylon
 Releasable Cable Straps
 Honda # 90672-SA0-0030
 25 Pcs.

9325PK



8" Length
 Up To 1 3/4" Bundle Diameter
 50 lbs. T/Strength 1/4" Hole Dia.
 UV Black Nylon
 Push-Mount Cable Ties
 25 Pcs.



**Low Profile
ATM
Blade Type
Mini Fuses**

Part Number	Amp Rating	Color	Pkg Qty
10829PK	5	Tan	5
10830PK	7.5	Brown	5
10831PK	10	Red	5
10832PK	15	Blue	5
10833PK	20	Yellow	5
10834PK	25	Natural	5
10835PK	30	Green	5



**ATM
Blade Type
Mini Fuses**

Part Number	Amp Rating	Color	Pkg Qty
1734PK	5	Orange	5
1734PK10	5	Orange	10
1735PK	7.5	Brown	5
1735PK10	7.5	Brown	10
1736PK	10	Red	5
1736PK10	10	Red	10
1737PK	15	Blue	5
1737PK10	15	Blue	10
1738PK	20	Yellow	5
1738PK10	20	Yellow	10
1739PK	25	White	5
1739PK10	25	White	10
1740PK	30	Green	5
1740PK10	30	Green	10

*PK10s come in a miniature clear plastic box.

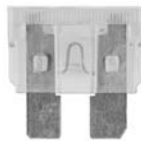

**ATO
Blade Type
Standard Fuses**

Part Number	Amp Rating	Color	Pkg Qty
1709PK	5	Orange	5
*1709PK10	5	Orange	10
1710PK	7.5	Brown	5
*1710PK10	7.5	Brown	10
1711PK	10	Red	5
*1711PK10	10	Red	10
1712PK	15	Blue	5
*1712PK10	15	Blue	10
1713PK	20	Yellow	5
*1713PK10	20	Yellow	10
1714PK	25	White	5
*1714PK10	25	White	10
1715PK	30	Green	5
*1715PK10	30	Green	10

*PK10s come in a miniature clear plastic box.

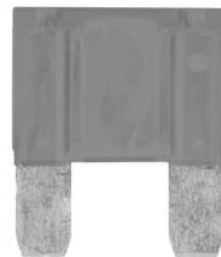

**ATX
Blade Type
Maxi Fuses**

Part Number	Amp Rating	Color	Pkg Qty
1785PK	20	Yellow	2
1786PK	30	Green	2
1787PK	40	Orange	2
1788PK	50	Red	2
1789PK	60	Blue	2

10

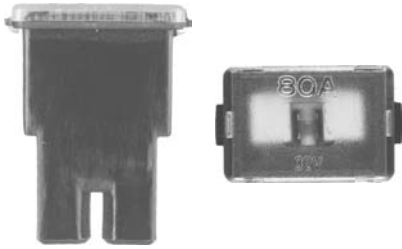

**Female
PAL
(Pacific Auto Link)
Fuses**

Part Number	Amp Rating	Color	Pkg Qty
2085PK	20	White	1
2086PK	30	Pink	1
2087PK	40	Green	1
2088PK	50	Red	1
2089PK	60	Yellow	1
2090PK	80	Black	1

724



**Clear
Single Contact
Base Type: T-2 3/4 Wedge
Usage: Instrument
Miniature Light Bulbs
Industrial # 24
10 Pcs. Per Box**

724A



**Dark Amber
Single Contact
Base Type: T-2 3/4 Wedge
Usage: Instrument
Miniature Light Bulbs
Industrial # 24A
10 Pcs. Per Box**

753



**Clear
Single Contact
Base Type: Bayonet (BA9s)
Usage: Indicator, Step, Courtesy
Miniature Light Bulbs
Industrial # 53
10 Pcs. Per Box**

757



**Clear
Single Contact
Base Type: Bayonet (BA9s)
Usage: Instrument
Miniature Light Bulbs
Industrial # 57
10 Pcs. Per Box**

767



Clear
Single Contact
Base Type: Bayonet (BA15s)
Usage: Park, License, Tail
Miniature Light Bulbs
Industrial # 67
10 Pcs. Per Box

768



Clear
Double Contact
Base Type: Bayonet (BA15d)
Usage: General Purpose
Miniature Light Bulbs
Industrial # 68
10 Pcs. Per Box

789



Clear
Single Contact
Base Type: Bayonet (BA15s)
Usage: Instrument, Hood, Tail
Miniature Light Bulbs
Industrial # 89
10 Pcs. Per Box

797



Clear
Single Contact
Base Type: Bayonet (BA15s)
Usage: Park, Clearance, Dome
Miniature Light Bulbs
Industrial # 97
10 Pcs. Per Box

7168

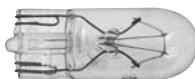

Clear
Single Contact
Base Type: T-3 1/4 Wedge
Usage: Instrument, Clock
Miniature Light Bulbs
Industrial # 168
10 Pcs. Per Box

7194

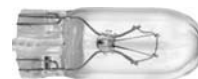

Clear
Single Contact
Base Type: T-3 1/4 Wedge
Usage: Side, Indicator, Warning
Miniature Light Bulbs
Industrial # 194
10 Pcs. Per Box

10

7194B



Clear
Base Type: T-3 1/4 Wedge
Miniature Light Bulbs
Industrial # 194
100 Pcs. Per Box

7194A



Dark Amber
Single Contact
Base Type: T-3 1/4 Wedge
Usage: Parking, Sidemarker
Miniature Light Bulbs
Industrial # 194A
10 Pcs. Per Box

7211-2

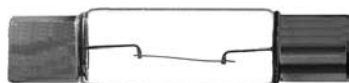

Clear
Double End Cap Type
Base Type: T-3
Usage: Instrument, Dome, Map
Miniature Light Bulbs
Industrial # 211-2
10 Pcs. Per Box

7212-2

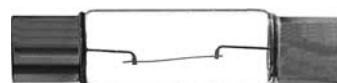

Clear
Double End Cap Type
Base Type: T-3
Usage: Dome
Miniature Light Bulbs
Industrial # 212-2
10 Pcs. Per Box

7257

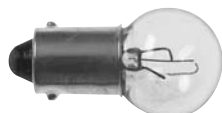

Clear
Single Contact
Base Type: Bayonet (BA9s)
Usage: General Purpose
Miniature Light Bulbs
Industrial # 257
10 Pcs. Per Box

7906



Clear
Single Contact
Base Type: T-5 Wedge
Usage: Instrument, Courtesy
Miniature Light Bulbs
Industrial # 906
10 Pcs. Per Box

7906A

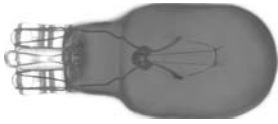

Dark Amber
Single Contact
Base Type: T-5 Wedge
Usage: Dome, Trunk
Miniature Light Bulbs
Industrial # 906A
10 Pcs. Per Box

7912



Clear
Single Contact
Base Type: T-5 Wedge
Usage: Dome, Trunk
Miniature Light Bulbs
Industrial Bulb # 912
10 Pcs. Per Box

7916



Clear
Single Contact
Base Type: T-5 Wedge
Usage: Sidemarker
Miniature Light Bulbs
Industrial Bulb # 916
10 Pcs. Per Box

7916A



Dark Amber
Single Contact
Base Type: T-5 Wedge
Usage: Sidemarker
Miniature Light Bulbs
Industrial Bulb # 916A
10 Pcs. Per Box

7921

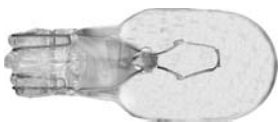

Clear
Single Contact
Base Type: T-5 Wedge
Usage: High Mount Stop
Miniature Light Bulbs
Industrial Bulb # 921
10 Pcs. Per Box

71003



Clear
Single Contact
Base Type: Bayonet (BA15s)
Miniature Light Bulbs
Usage: Trunk, Hood, Courtesy
Industrial Bulb # 1003
10 Pcs. Per Box

10

71004



Clear
 Double Contact
 Base Type: Bayonet (BA15s)
 Usage: Under Hood
 Miniature Light Bulbs
 Industrial # 1004
 10 Pcs. Per Box

71141



Clear
 Single Contact
 Base Type: Bayonet (BA15s)
 Usage: Backup
 Miniature Light Bulbs
 Industrial Bulb # 1141
 10 Pcs. Per Box

71156



Clear
 Single Contact
 Base Type: Bayonet (BA15s)
 Usage: Corner, Backup, Stop
 Miniature Light Bulbs
 Industrial Bulb # 1156
 10 Pcs. Per Box

71156A



Dark Amber
 Single Contact
 Base Type: Bayonet (BA15s)
 Usage: Park
 Miniature Light Bulbs
 Industrial Bulb # 1156A
 10 Pcs. Per Box

71157



Clear
 Double Contact
 Base Type: Bayonet (BAY15d)
 Usage: Tail, Stop
 Miniature Light Bulbs
 Industrial Bulb # 1157
 10 Pcs. Per Box

71157A



Dark Amber
 Double Contact
 Base Type: Bayonet (BA15d)
 Usage: Signal, Park
 Miniature Light Bulbs
 Industrial Bulb # 1157A
 10 Pcs. Per Box

71893



Clear
Single Contact
Base Type: Bayonet (BA9s)
Usage: Indicator, Step, Courtesy
Miniature Light Bulbs
Industrial Bulb # 1893
10 Pcs. Per Box

71895



Clear
Single Contact
Base Type: Bayonet (BA9s)
Usage: Clock, Glove Box
Miniature Light Bulbs
Industrial Bulb # 1895
10 Pcs. Per Box

72057



Clear
Double Contact
Base Type: Bayonet (BAY15d)
Usage: Stop, Tail, Park
Miniature Light Bulbs
Industrial Bulb # 2057
10 Pcs. Per Box

72057A



Dark Amber
Double Contact
Base Type: Bayonet (BAY15d)
Usage: Sidemarkers, Stop, Turn
Miniature Light Bulbs
Industrial Bulb # 2057A
10 Pcs. Per Box

72357



Clear
Double Contact
Base Type: Bayonet (BAY15d)
Usage: Signal, Park
Miniature Light Bulbs
Industrial Bulb # 2357
10 Pcs. Per Box

72357A



Dark Amber
Double Contact
Base Type: Bayonet (BA15d)
Usage: Signal, Park
Miniature Light Bulbs
Industrial Bulb # 2357A
10 Pcs. Per Box

10

73057



Clear
Double Contact
Base Type: Wedge
Usage: Signal, Stop
Minature Light Bulbs
Industrial Bulb # 3057
10 Pcs. Per Box

73057A



Amber
Double Contact
Base Type: Wedge
Usage: Park, Signal
Minature Light Bulbs
Industrial Bulb # 3057A
10 Pcs. Per Box

73156



Clear
Single Contact
Base Type: Wedge
Usage: Corner, Backup
Minature Light Bulbs
Industrial Bulb # 3156
10 Pcs. Per Box

73156A

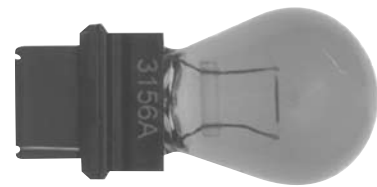

Amber
Single Contact
Base Type: Wedge
Usage: Corner, Backup
Minature Light Bulbs
Industrial Bulb # 3156A
10 Pcs. Per Box

73157



Clear
Double Contact
Base Type: Wedge
Usage: Park, Signal
Minature Light Bulbs
Industrial Bulb # 3157
10 Pcs. Per Box

73157A

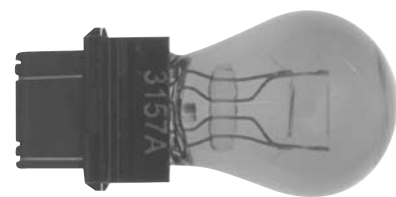

Amber
Double Contact
Base Type: Wedge
Usage: Signal, Stop, Tail
Minature Light Bulbs
Industrial Bulb # 3157A
10 Pcs. Per Box

73357



Clear
Double Contact
Base Type: Wedge
Usage: Park, Signal
Miniature Light Bulbs
Industrial Bulb # 3357
10 Pcs. Per Box

73357A

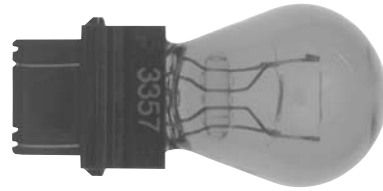

Amber
Double Contact
Base Type: Wedge
Usage: Park, Signal
Miniature Light Bulbs
Industrial Bulb # 3357A
10 Pcs. Per Box

73457



Clear
Double Contact
Base Type: S-8 Wedge
Usage: Park, Signal
Miniature Light Bulbs
Industrial # 3457
10 Pcs. Per Box

73457A



Dark Amber
Double Contact
Base Type: S-8 Wedge
Usage: Stop, Turn
Miniature Light Bulbs
Industrial # 3457A
10 Pcs. Per Box

73496



Clear
Double Contact
Base Type: Bayonet (BAY15d)
Usage: Tail, Stop, Sidemaker, Signal
Miniature Light Bulbs
Industrial # 3496
10 Pcs. Per Box.

73497



Clear
Single Contact
Base Type: Bayonet (BA15s)
Usage: Directional, Stop
Miniature Light Bulbs
Industrial # 3497
10 Pcs. Per Box

10

74114K

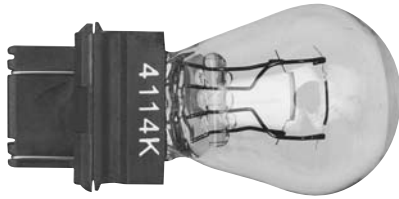

Clear
Base Type: Wedge
Type Krypton Filled Gas
Usage: Daytime Running Lights
Miniature Light Bulbs
Industrial # 4114K
10 Pcs. Per Box

74157



Clear
Double Contact
Base Type: Wedge
Usage: Daytime Running
Miniature Light Bulbs
Industrial Bulb # 4157
10 Pcs. Per Box

74157K

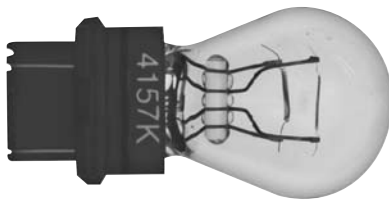

Clear
Base Type: Wedge
Krypton Filled Gas
Usage: Daytime Running
Miniature Light Bulbs
Industrial # 4157K
10 Pcs. Per Box

74157NAK



Natural Amber
Base Type: Wedge
Krypton Filled Gas
Usage: Daytime Running
Miniature Light Bulbs
Industrial Bulb # 4157NAK
10 Pcs. Per Box

77440



Clear
Single Contact
Base Type: T-6 1/2 Wedge
Usage: Tail Light
Miniature Light Bulbs
Industrial Bulb # 7440
10 Pcs. Per Box

77440A

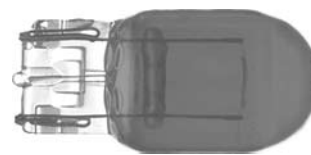

Amber
Single Contact
Base Type: T-6 1/2 Wedge
Usage: Signal, Backup
Miniature Light Bulbs
Industrial Bulb # 7440A
10 Pcs. Per Box

77443



Clear
 Double Contact
 Base Type: T-6 1/2 Wedge
 Usage: Tail, Brake Light
 Miniature Light Bulbs
 Industrial Bulb # 7443
 10 Pcs. Per Box

77443A

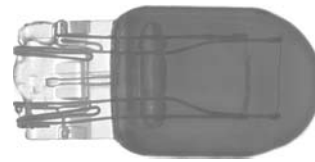

Amber
 Double Contact
 Base Type: T-20 1/2 Wedge
 Usage: Stop, Tail
 Miniature Light Bulbs
 Industrial Bulb # 7443A
 10 Pcs. Per Box

7H1

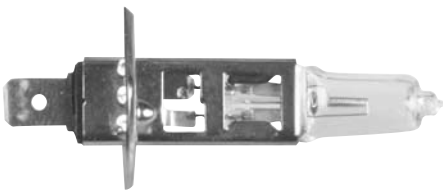

Clear
 12 Volt 55 Watt
 Base Type: P14.5s
 Bulb Shape: T-2 1/2
 Halogen Headlight Bulb
 Industrial # H1
 1 Pc. Per Box

7H3

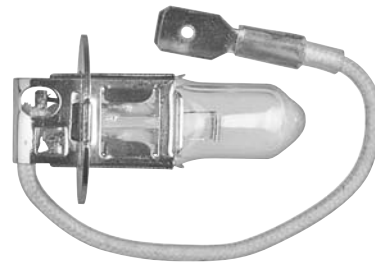

Clear
 12 Volt 55 Watt
 Base Type: PK22s
 Bulb Shape: T-3 1/4
 Halogen Headlight Bulb
 Industrial # H3
 1 Pc. Per Box

7H7



Clear
 12 Volt 55 Watt
 Base Type: PX26d
 Bulb Shape: T-4 5/8
 Halogen Headlight Bulb
 Industrial #H7
 1 Pc. Per Box

7H4 (Please order 79003)



12.8 Volt 55/60 Watt
 Type: PX43t-38
 Usage: High & Low Beam
 Clear Halogen Headlight Bulb
 Industrial Bulb #H4 (9003)
 1 Pc. Per Box

10

7D2C



85 Volt 35 Watt
 Base Type: T-3 P32d2
 High Intensity Discharge (HID)
 Reflector or Projection System
 Clear Xenon Headlight Bulb
 Industrial # D2C
 1 Pc. Per Box

7D2R

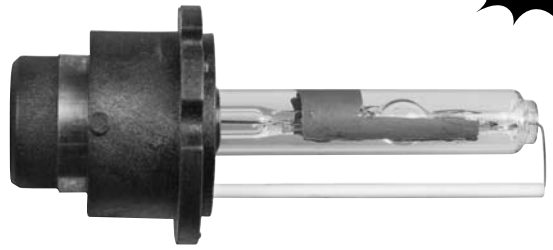

85 Volt 35 Watt
 Base Type: T-3 P32d2
 High Intensity Discharge (HID)
 Reflector System
 Clear Xenon Headlight Bulb
 Industrial # D2R
 1 Pc. Per Box

7D2S



85 Volt 35 Watt
 Base Type: T-3 P32d2
 High Intensity Discharge (HID)
 Projection System
 Clear Xenon Headlight Bulb
 Industrial # D2S
 1 Pc. Per Box

7H8



12 Volt 35 Watt
 Base Type: PGJ19-1
 Bulb Shape: T-4
 Clear Halogen Fog Light
 Industrial # H8
 1 Pc. Per Box

7H9



12 Volt 65 Watt
 Base Type: PGJ19-5
 Bulb Shape: T-4
 Clear Halogen Headlight Bulb
 Industrial # H9
 1 Pc. Per Box

7H10

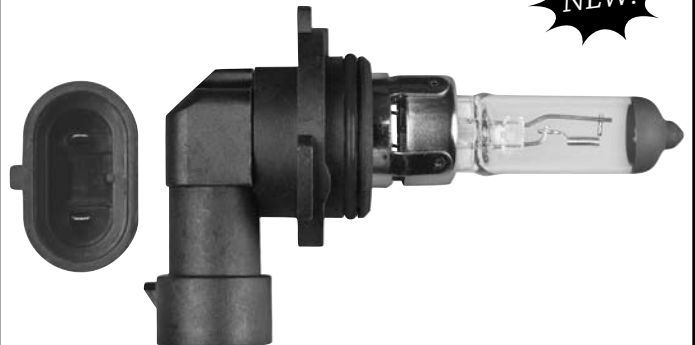

12 Volt 45 Watt
 Base Type: PY20d
 Clear Halogen Fog Light
 Industrial # H10 (9145)
 1 Pc. Per Box

7H11

NEW!



12 Volt 55 Watt
Base Type: PGJ19-2
Bulb Shape: T-4
Clear Halogen Fog & Headlight Bulb
Industrial # H11
1 Pc. Per Box

7H13

NEW!

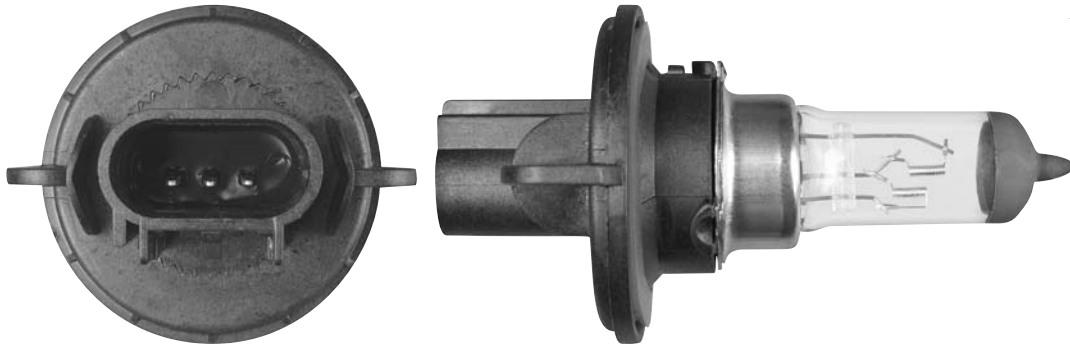

12.8 Volt 55/65 Watt
Base Type: P26.4t
Usage: High & Low Beam
Clear Halogen Headlight Bulb
Industrial # H13 / 9008
1 Pc. Per Box

7880

NEW!

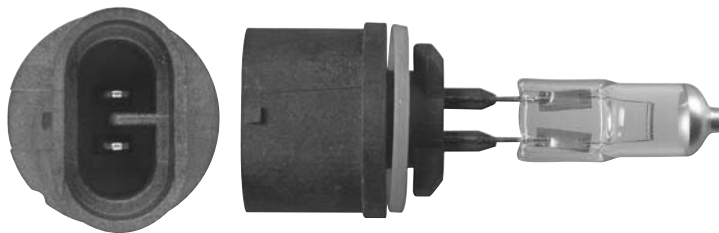

12 Volt 27 Watt
Base Type:T-3 1/4
Usage: Fog & Auxillary
Clear Halogen Headlight Bulb
Industrial Bulb # 880
1 Pc. Per Box

10

7886

NEW!

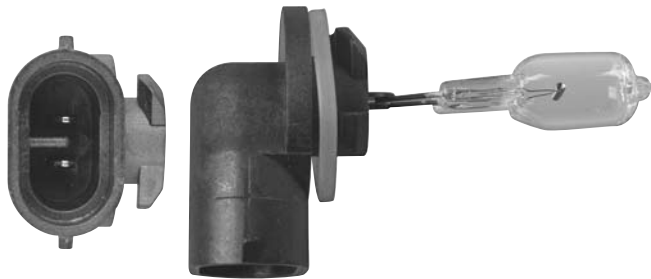

12 Volt 50 Watt
Base Type: T-3 1/4
Clear Halogen Headlight Bulb
Industrial Bulb # 886
1 Pc. Per Box

7889

NEW!



12 Volt 27 Watt
Base Type: T-3 1/4
Clear Halogen Headlight Bulb
Industrial Bulb # 889
1 Pc. Per Box

7890

NEW!



12 Volt 27 Watt
Base Type: T-3 1/4
Usage: Signal, Park & Back-up
Clear Halogen Headlight Bulb
Industrial Bulb # 890
1 Pc. Per Box

7891



**12 Volt 8 Watt
Base Type: T-2 1/4
Usage: High Mount Stop
Clear Halogen Headlight Bulb
Industrial Bulb # 891
1 Pc. Per Box**

7894

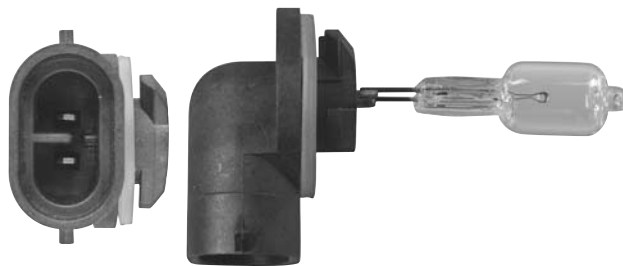

**12.8 Volt 37.5 Watt
Base Type: T-3 1/4
Clear Halogen Headlight Bulb
Industrial Bulb # 894
1 Pc. Per Box**

7899



**12.8 Volt 37.5 Watt
Base Type: T-3 1/4
Right Angle High Mount
Clear Halogen Headlight Bulb
Industrial Bulb # 899
1 Pc. Per Box**

10

79003

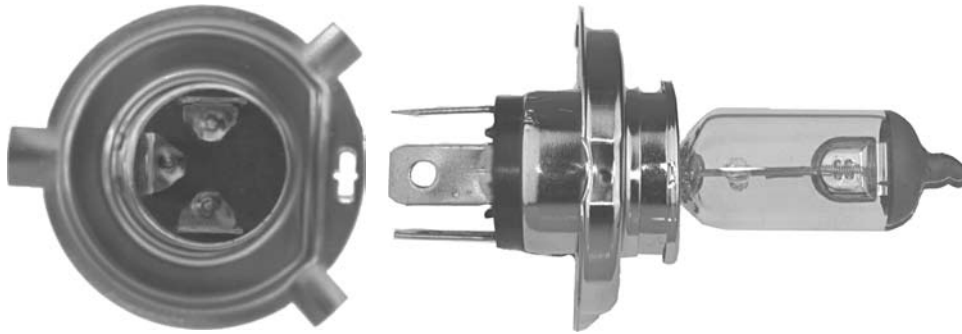

Clear, 12.8 Volt 55/60 Watt
Base Type: PX43t-38
Usage: High & Low Beam
Halogen Headlight Bulb Industrial Bulb #9003
1 Pc. Per Box

79004



12.8 Volt 65/45 Watt Base Type: P29t
Usage: High & Low Beam
Clear Halogen Headlight Bulb Industrial # 9004
Use with Disco Socket #1396
1 Pc. Per Box

79005

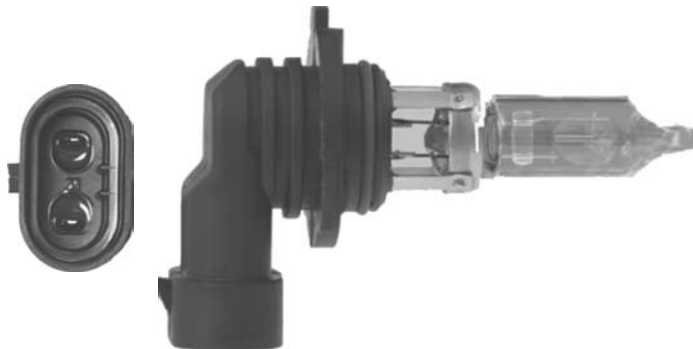

12.8 Volt 65 Watt
Base Type: T-4 3/4 Usage: High Beam
Clear Halogen Headlight Bulb
Industrial Bulb #9005
1 Pc. Per Box

79006

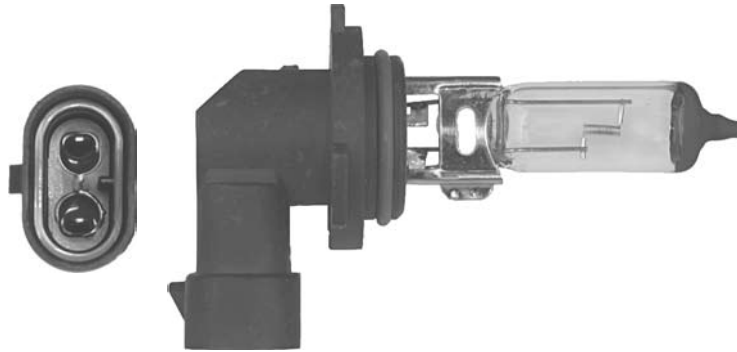

12.8 Volt 55 Watt
Base Type: T-4 1/24 Usage: Low Beam
Clear Halogen Headlight Bulb
Industrial Bulb #9006
1 Pc. Per Box

79007



12.8 Volt 55/65 Watt
Base Type: T-4 5/8 Usage: High & Low Beam
Clear Halogen Headlight Bulb
Industrial # 9007
Use with Disco Socket # 1396
1 Pc. Per Box

10728PK

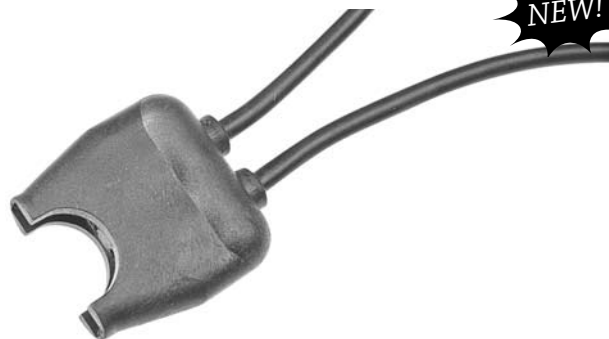

7" Wire Leads
14 Gauge Wire
Use With ATO/ATC Fuses
Open Type
In-Line Fuse Holders
5 Pcs.

10

10729PK

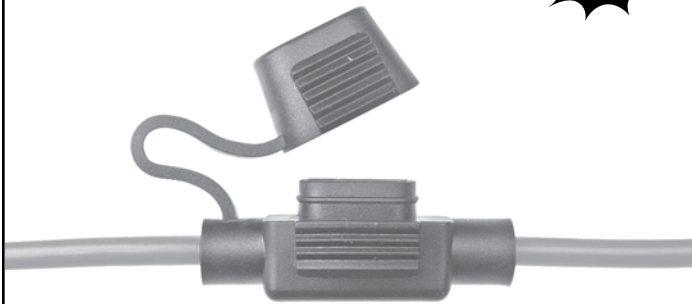

6" Wire Leads
12 Gauge Wire
Use With ATM Fuses
Closed Type
In-Line Fuse Holders
1 Pc.

10730PK

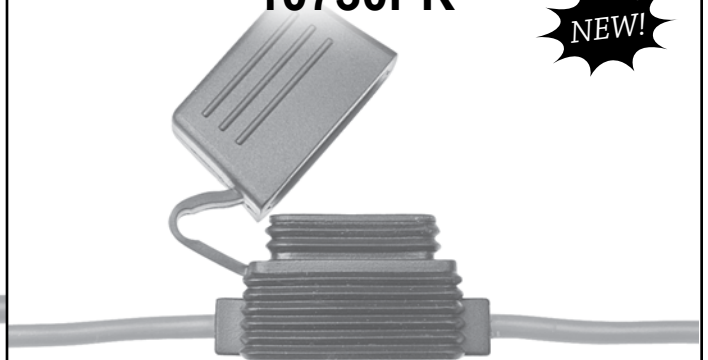

6" Wire Leads
14 Gauge Wire
Use With ATO/ATC Fuses
Closed Type
In-Line Fuse Holders
1 Pc.

10731PK

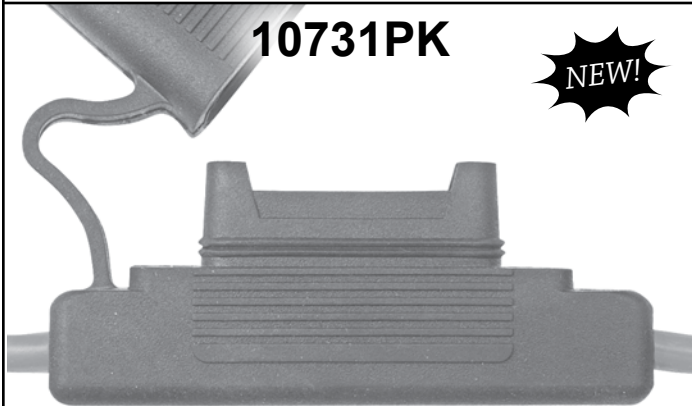

5" Wire Leads
8 Gauge Wire
Use With ATX Fuses
Closed Type
In-Line Fuse Holders
1 Pc.

1396PK



Headlamp Pigtail
(3) All Black 10" Leads 18ga
Blue Housing
Usage: Compact import and domestic cars '88+
Fits bulbs # 9004, 9007
G.M. 12048369
1 Pc.

9769PK



Air Conditioning Clutch Field Coil Connector Pigtail
(2) 12" Leads Pink & Tan
Gray Housing
Usage: Ford '80+
10 Pcs.

9774PK



Stop/Tail/Turn & Parking Light Pigtail
(3) 18ga (TXL) Leads Black Brown, Green/Gold
Black Housing
Usage: Ford Ranger, Explorer, Econoline '91+
1 Pc.

9771PK



Power Brake Connector Pigtail
 (2) 12" Leads Green & Green/Red
 Black Housing
 Usage: Ford '65+
 Ford # D1AZ-13410-A
 10 Pcs.

9767PK



Vehicle Speed Sensor Pigtail
 ABS Wheel Speed Sensor
 (2) White GXL 8" Leads
 Black Housing
 Usage: Fits various model Fords '93+
 Ford Base # 9E731
 1 Pc.

9768PK



Alternator Socket Assembly
 (3) 10" Leads (2) 10ga Black/Orange
 (1) 20ga White
 Black Housing
 Usage: Ford Aerostar, Tempo, Topaz, Taurus &
 Sable w/ 6 Cyl. & 75 Amp. Alternator
 '89+ 4 Cyl '85+
 1 Pc.

9908PK



Ford Alternator Harness
 (2) 16 ga. (TXL) 8" Leads
 Usage: Ford Alt. F81Z-10346-EARM
 Ford 250 & 350 7.3 Diesel Eng., Cr. Vic.
 Grand Marq., Town Car, Contour & Mystique
 Ford
 1 Pc.

9907PK



Ford Alternator Harness
 (3) 14 ga. (TXL) 8" Leads
 Usage: Ford Alt. 1U2Z-14S411-TA, WPT118
 Ford
 1 Pc.

9909PK



Brake Lamp Switch
 (2) 18 ga. (TXL) 8" Leads
 Usage: Fits Switch
 # YF1Z-13480-AA & # YF1Z-13480-BA
 Wire harness Connector
 Ford
 1 Pc.

10

9776PK



Voltage Regulator Pigtail
 (3) 10" Leads (1) 14ga, (2) 20ga
 Green, White, Blue
 Gray Housing
 Usage: Sable, Taurus, Tempo, Topaz with
 Internal Voltage regulator '86+
 1 Pc.

9778PK

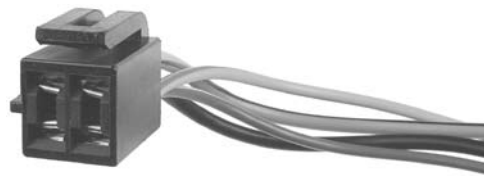

Heater & Air Conditioning Fan Speed Pigtail
 (4) 8" Leads (1) 16ga (1) 14ga (2) 12ga
 Yellow, Green, Orange, Black
 Black Housing
 Usage: Switches E6DZ-A, E9SZ-A, F2DZ-A,
 F2UZ-19986A,B
 Ford Cougar, E-Van, Mustang, Sable, Taurus,
 T-Bird '86+
 1 Pc.

9798PK



Turn Signal & Windshield Wiper Pigtail
 (2) 16ga (2) 12ga (GPT) 8" Leads
 Gray Housing
 Usage: Ford Multiswitch Base No. 13K359
 1 Pc.

9834PK



Ford Multi-Switch Function Pigtail
 (9) 16ga (GPT) 8" Leads
 Gray Housing
 Usage: Ford Multi Function Switch Base No. 13K359
 1 Pc.

9775PK



Marker & License Socket Pigtail
 (2) 9" Leads Brown & Black
 Beige Housing
 Usage: Fits bulbs #158, 194, 194A
 GM # 629886 / 6298892 / 6298935 / 8915827
 Ford # D0DZ-15A434-B
 5 Pc.

9813PK



Blower Motor Resistor Pigtail
 1st Pigtail: (1ea) 10, 12, 14, 16ga (White Housing)
 2nd Pigtail: (1) 18" 12ga Lead White Housing
 Usage: Fits Resistors F1CZ-19A706-A &
 F7CZ-19A706-AA
 Ford Escort & Tracer '91+
 1 Pc.

9770PK

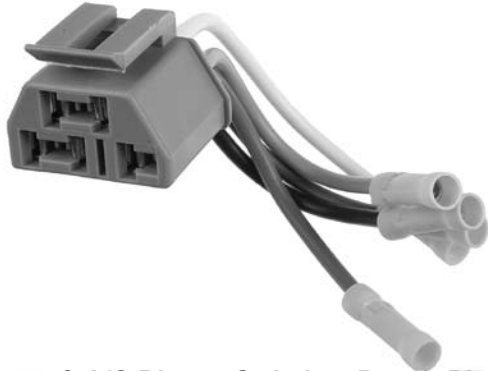

Heater & A/C Blower Switches Repair Pigtail
 (5) 5" 12ga Leads Red, Orange, White, Green, Black
 Gray Housing
 Usage: Fits most Ford Switches w/ Base # 19986 '73+
 1 Pc.

9777PK



Turn Signal & Windshield Wiper Repair Pigtail
 (10) 16ga (GPT) 8" Leads
 Gray Housing
 Usage: Switches E9DZ-13K359-A, B, C;
 E8ZZ-13K359-B; F0ZZ13K1359-A
 Ford Mustang '87-93, Sable & Taurus '86-89
 1 Pc.

9799PK



Ford MultiSwitch Pigtail
 (11) 18ga (TXL) 8" Leads
 Gray Housing
 Usage: Ford Multi Function Switch Base No. 13K359
 1 Pc.

9800PK

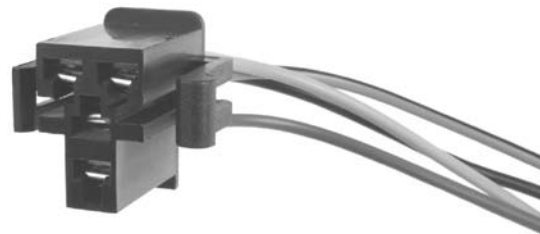

Air Conditioning Blower Motor Resistor Pigtail
 (4) 8" Leads 14ga Black, Orange, Yellow, Green
 Black Housing
 Usage: Fits Resistor E7TZ-19A706-A
 Ford Trucks '83+
 Ford # E7TZ-19A706-A
 1 Pc.

9772PK

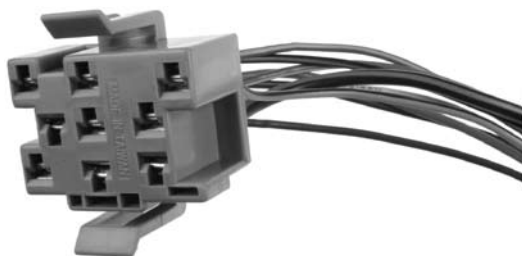

Dash Mounted Headlamp Switch repair Harness
 (9) 8" Leads (3) 20ga, (4) 8ga (1) 16ga (1) 12ga
 Gray Housing
 Usage: First Most Switch w/ Ford Base No. 11654
 Ford Cars / Trucks '84+
 1 Pc.

9773PK



Fuel Injection Plug w/ External Spring Clip Retainer
 (2) 18ga (SXL) Leads White
 Black Housing
 Usage: Compact import and domestic cars
 1 Pc.

10

9779PK

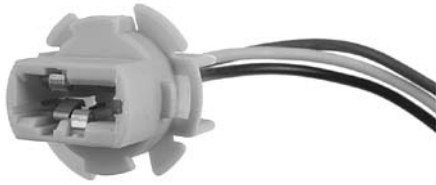

Light Socket Pigtail
(3) 10" Leads Yellow, Brown, Black
Beige Housing
Usage: Nissan light socket plug. Fits bulb #7443
1 Pc.

9780PK



Light Socket Pigtail
(2) 11" Leads Brown, Black
Gray Housing
Usage: Nissan light socket plug. Fits bulb #7440
1 Pc.

729PK



Use on 14-16-18 Ga. Wire
In Line Self Stripping
Blue Nylon
Wire Connectors
25 Pcs.

9996PK



Joins 18 & 16 Gauge Wire
2 #18 Ga. Wire Min.
2 #16 Ga. Wire Max.
Hard Type
Grey Wire Nuts
25 Pcs.

2066PK



22-18 Ga. Wire
UL Approved
Polyolefin Tubing Shrink Ratio 3-1
Heat Shrink Type
Red Butt Connectors
25 Pcs.

2067PK



16-14 Ga. Wire
UL Approved
Polyolefin Tubing Shrink Ratio 3-1
Heat Shrink Type
Blue Butt Connectors
25 Pcs.

2068PK



12-10 Ga. Wire
UL Approved
Polyolefin Tubing Shrink Ratio 3-1
Heat Shrink Type
Yellow Butt Connectors
25 Pcs.

3600PK



Red Nylon
22-18 Gauge Wire Range
Seamless Butt Connectors
50 Pcs.

3601PK



Blue Nylon
16-14 Gauge Wire Range
Seamless Butt Connectors
50 Pcs.

3602PK



Yellow Nylon
12-10 Gauge Wire Range
Seamless Butt Connectors
50 Pcs.

10710PK



22-24 AWG
Solder & Seal Type
Clear Heat Shrink Tubing
Butt Connectors
15 Pcs.

10711PK



18-20 AWG
Solder & Seal Type
Red Heat Shrink Tubing
Butt Connectors
15 Pcs.

10

10712PK



**14-16 AWG
Solder & Seal Type
Blue Heat Shrink Tubing
Butt Connectors
15 Pcs.**

10713PK



**10-12 AWG
Solder & Seal Type
Yellow Heat Shrink Tubing
Butt Connectors
15 Pcs.**



Tools

1146



10" Overall Length
Has Nose Pieces for 3/32, 1/8, 5/32 & 3/16" Diameter Rivets
Hand Riveter
Sold Each

9499

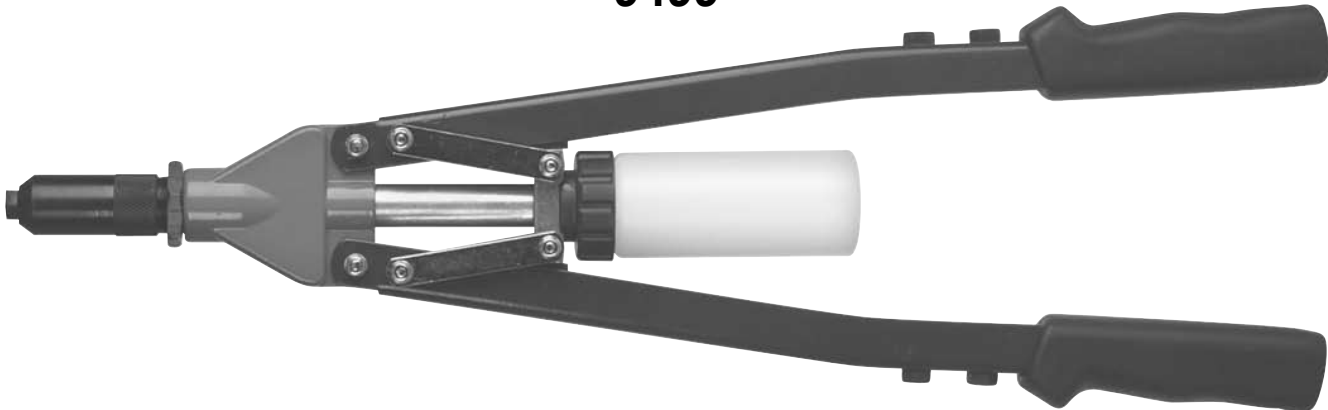

21" Overall Length
Has Nose Pieces for 1/8, 5/32, 3/16, 7/32 & 1/4" Diameter Rivets
Heavy Duty Hand Riveter
Sold Each

1204



6 1/2" Long
Use for all Size Rivets
(For Nylon Rivets Only)
Single Stroke
Rivet Setter Gun
Sold Each

9956

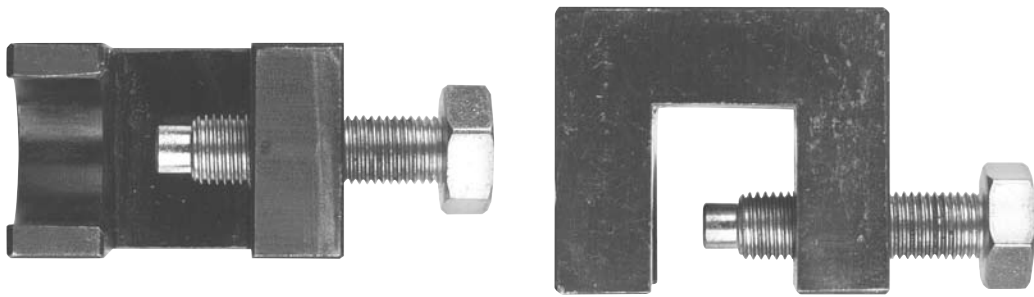

Door Hing Pin Removal Tool
Used to remove #10060 & 10065 Hinge Pin Kits
Sold Each

10690

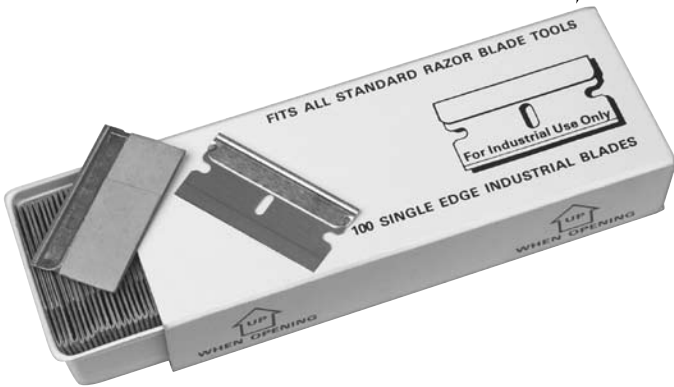

**Single Edge
Industrial Razor Blades
100 Pcs.**

10880PK



**6mm Drill Size
For 1/4" Spot Welds
High Speed Steel
Gold Finish Cobalt Steel
Spot Weld Drill Bits
3 Pcs.**

10881PK



**8mm Drill Size
For 5/16" Spot Welds
High Speed Steel
Gold Finish Cobalt Steel
Spot Weld Drill Bits
3 Pcs.**

10882PK



**10mm Drill Size
For 3/8" Spot Welds
High Speed Steel
Gold Finish Cobalt Steel
Spot Weld Drill Bits
3 Pcs.**

10841PK



8mm Drill Size
For 5/16" Spot Welds
Cobalt Spur Point
Gold Finish High Speed Steel
Spot Weld Drill Bits
3 Pcs.

10842PK



10mm Drill Size
For 3/8" Spot Welds
Cobalt Spur Point
Gold Finish High Speed Steel
Spot Weld Drill Bits
3 Pcs.

10843PK



1/8" (.125) Drill Size
135° Split Point
High Speed Steel
Double End Drill Bits
10 Pcs.

10844PK



3/16" (.1875) Drill Size
135° Split Point
High Speed Steel
Double End Drill Bits
5 Pcs.

10845PK



1/4" (.250) Drill Size
135° Split Point
High Speed Steel
Double End Drill Bits
5 Pcs.

11

Assortments

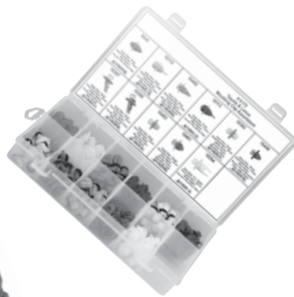
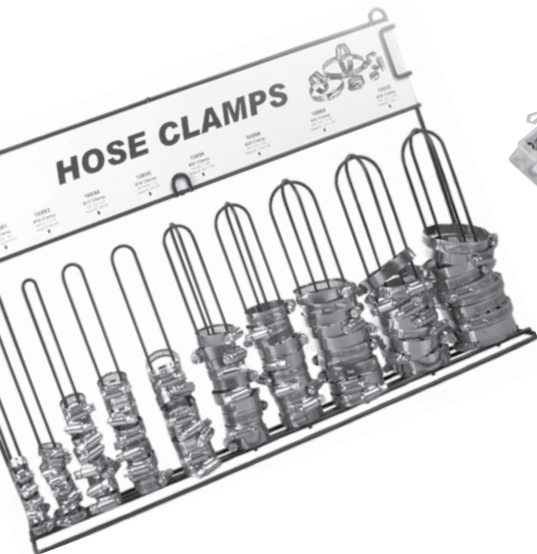
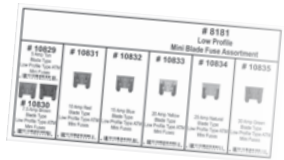
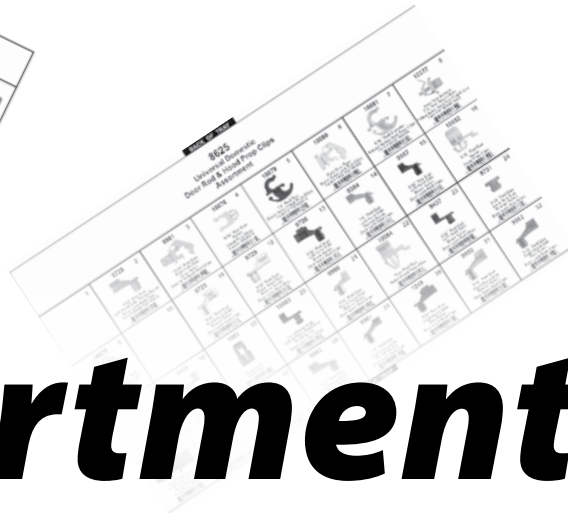
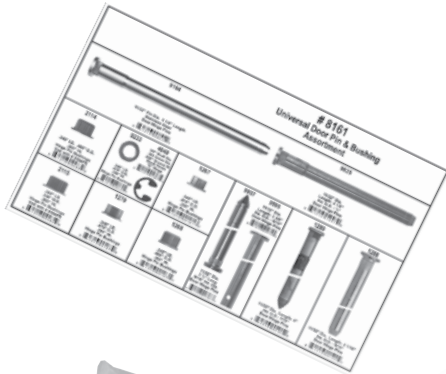



# 8101 Universal Body Shim Assortment					
# 9636	# 9637	# 6015	# 6016	# 9974	# 9975
1/16" Thick 3/8" Slot 15/16" Outside Diameter Round Type Zinc Plated Steel Body Shims	1/8" Thick 3/8" Slot 15/16" Outside Diameter Round Type Zinc Plated Steel Body Shims	1/16" Thick 3/8" Slot 1 1/4" x 1 1/8" Bright Zinc Finish Steel Body Shims	1/8" Thick 3/8" Slot 1 1/4" x 1 1/8" Bright Zinc Finish Steel Body Shims	1/16" Thick 1/2" Slot 1 1/8" x 1 1/8" Bright Zinc Finish Steel Body Shims	1/8" Thick 1/2" Slot 1 1/8" x 1 1/8" Bright Zinc Finish Steel Body Shims

8101 (Plastic Tray)
 Shipped In a 6 Hole Plastic Tray
 Covers 3/8" & 1/2" Slot Sizes
 Bright Zinc Finish
 Contains 6 Different Sizes
 140 Total Pcs.
 Body Shim Assortment
 Sold Each



8101R (Refill Kit)
 Shipped In a 8" x 10" Plastic Bag
 Sold Each

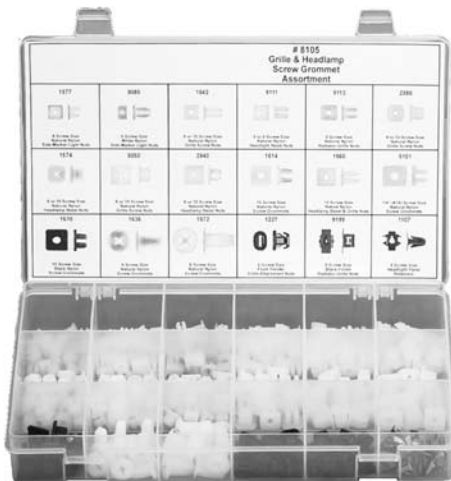

# 8105 Grille & Headlamp Screw Grommet Assortment					
1577	9085	1842	9111	9113	2980
8 Screw Size Natural Nylon Side Marker Light Nuts	6 Screw Size White Nylon Side Marker Light Nuts	8 or 10 Screw Size Natural Nylon Grille Screw Nuts	6 to 8 Screw Size Natural Nylon Headlight Bezel Nuts	8 Screw Size Natural Nylon Radiator Grille Nuts	8 to 10 Screw Size Natural Nylon Grille Screw Nuts
1574	9050	2940	1614	1560	9101
8 or 10 Screw Size Natural Nylon Headlamp Bezel Nuts	8 or 10 Screw Size Natural Nylon Grille Screw Nuts	8 or 10 Screw Size Natural Nylon Headlamp Bezel Nuts	10 Screw Size Natural Nylon Screw Grommets	10 Screw Size Natural Nylon Headlamp Bezel & Grille Nuts	1/4" (9/16) Screw Size Natural Nylon Screw Grommets
1610	1636	1572	1227	9199	1107
10 Screw Size Black Nylon Screw Grommets	6 Screw Size Natural Nylon Screw Grommets	8 Screw Size Natural Nylon Screw Grommets	6 Screw Size Front Fender Grille Attachment Nuts	8 Screw Size Black Finish Radiators Grille Nuts	8 Screw Size Headlight Panel Retainers

8105 (Plastic Tray)
 Shipped In a 18 Hole Plastic Tray
 Covers G.M., Ford, & Chrysler
 All Nylon
 Contains 18 Different Sizes
 330 Total Pcs.
 Grille & Headlamp Grommet Assortment
 Sold Each

12

NEW!



# 8109 Import Fender Flare, Garnish Moulding & Door Trim Panel Retainer Assortment					
# 10750 8.2mm Hole Size Top Head Dia : 10mm x 13mm Stem Length: 11mm Toyota Yellow Nylon Fender Flare Retainers	# 10687 8.5mm Hole Size Top Head Diameter : 13mm Stem Length: 14mm Toyota Turquoise Nylon Door Trim Panel Retainers	# 10751 8.75mm Hole Size Top Head Diameter : 13mm Stem Length: 11mm Toyota White Nylon Garnish Moulding Retainers	# 2145 8mm Hole Size Top Head Diameter : 13mm Stem Length: 11mm Toyota Natural Nylon Door Trim & Garnish Retainers	# 10405 8mm Hole Size Top Head Diameter : 14mm Stem Length: 14mm Mazda White Nylon Door Trim Panel Retainers	# 10748 9mm Hole Size Stem Length: 13mm Toyota Natural Nylon Door Panel & Rockers Moulding Retainers
# 10744 8.8mm Hole Size Top Head Diameter : 13mm Stem Length: 10mm Hyundai Natural Nylon Trim Panel Retainers	# 10573 8.5mm Hole Size Top Head Diameter : 13mm Stem Length: 13mm Honda Orange Nylon Door Trim Panel Retainers	# 10752 9.1mm Hole Size Stem Length: 14mm Honda Orange Nylon Cowling Moulding & Radiator Support Retainers	# 10576 8mm Hole Size Top Head Diameter : 12.8mm Stem Length: 14mm Nissan Orange Nylon With Sealer Door Trim Panel Retainers	# 10575 8mm Hole Size Top Head Diameter : 15mm Stem Length: 10mm Mazda Black Nylon Door Trim Panel Retainers	# 10749 11.1mm Hole Size Stem Length: 14mm Mazda White Nylon Door Trim Panel Retainers With Sealer

8109 (Plastic Tray)
Shipped In a 12 Hole Plastic Tray
Covers Honda, Hyundai, Nissan,
Mazda & Toyota Cars
Contains 12 Different Sizes
170 Total Pcs.
Import Door Trim Panel Assortment
Sold Each

*Color Sales Brochures Available. Call for Details.



# 8110 ATM-ATO-ATX Blade Fuse Assortment					
# 1735PK 7.5 Amp Brown ATM Type Mini Fuse	# 1736PK 10 Amp Red ATM Type Mini Fuse	# 1737PK 15 Amp Blue ATM Type Mini Fuse	# 1738PK 20 Amp Yellow ATM Type Mini Fuse	# 1739PK 25 Amp White ATM Type Mini Fuse	# 1740PK 30 Amp Green ATM Type Mini Fuse
# 1709PK 5 Amp Orange ATO Type Standard Fuse	# 1710PK 7.5 Amp Brown ATO Type Standard Fuse	# 1711PK 10 Amp Red ATO Type Standard Fuse	# 1712PK 15 Amp Blue ATO Type Standard Fuse	# 1713PK 20 Amp Yellow ATO Type Standard Fuse	# 1714PK 25 Amp White ATO Type Standard Fuse
# 1715PK 35 Amp Green ATX Type Standard Fuse	# 1785PK 20 Amp Yellow ATX Type Mini Fuse	# 1786PK 30 Amp Green ATX Type Mini Fuse	# 1787PK 40 Amp Orange ATX Type Mini Fuse	# 1788PK 50 Amp Red ATX Type Mini Fuse	# 1789PK 60 Amp Blue ATX Type Mini Fuse

8110 (Plastic Tray)
Shipped In a 18 Hole Plastic Tray
Covers ATM, ATO, & ATX Style Fuses
Contains 18 Different Sizes
126 Total Pcs.
ATM, ATO, ATX Blade Fuse Assortment
Sold Each

12



# 8112 Phillips Trim Screw Assortment					
# 5765 8 x 1/2" 7/16" O.D. Washer Phillips Oval Washer Head Bright Zinc Finish Wheel Opening Midg. Tek® Screws	# 6010 8 x 1/2" 7/16" O.D. Washer Phillips Oval Washer Head Black Phosphate Finish Wheel Opening Midg. Tek® Screws	# 6265 8 x 3/4" 7/16" O.D. Washer Phillips Oval Washer Head Black Phosphate Finish Mounting Tek® Screws	# 6267 8 x 1" 7/16" O.D. Washer Phillips Oval Washer Head Black Phosphate Finish Mounting Tek® Screws	# 9256 4.8-1.6 x 15mm 14mm Head O.D. Phillips Truss Head Black Phosphate Finish Sheet Metal Screws	# 9260 6.3-1.81 x 16mm 15mm Head O.D. Phillips Truss Head Black Phosphate Finish Sheet Metal Screws
# 5791 8 x 1/2" 13/32" O.D. Washer Phil. Flat Top Washer Head Black Phosphate Finish Trim Screws	# 5984 8 x 3/4" 13/32" O.D. Washer Phil. Flat Top Washer Head Black Phosphate Finish Trim Screws	# 5989 8 x 1" 13/32" O.D. Washer Phil. Flat Top Washer Head Black Phosphate Finish Trim Screws	# 5990 8 x 1 1/4" 13/32" O.D. Washer Phil. Flat Top Washer Head Black Phosphate Finish Trim Screws	# 9497 10 x 3/4" 15/32" O.D. Washer Phil. Flat Top Washer Head Black Phosphate Finish Trim Screws	# 9498 10 x 1" 15/32" O.D. Washer Phil. Flat Top Washer Head Black Phosphate Finish Trim Screws
# 2370 1/2" x 3/4" 1/2" O.D. Washer Phil. Flat Top Washer Head Black Phosphate Finish Trim Screws	# 2975 1/2" x 1" 1/2" O.D. Washer Phil. Flat Top Washer Head Black Phosphate Finish Trim Screws	# 9145 1/2" x 3/4" 1/2" O.D. Washer Phil. Flat Top Washer Head Black Phosphate Finish Trim Screws	# 9146 1/2" x 1" 1/2" O.D. Washer Phil. Flat Top Washer Head Black Phosphate Finish Trim Screws	# 1795 8 x 3/4" 13/32" O.D. Washer Phil. Flat Top Washer Head Bright Zinc Finish Trim Screws	# 1796 8 x 1" 13/32" O.D. Washer Phil. Flat Top Washer Head Bright Zinc Finish Trim Screws

8112 (Plastic Tray)
 Shipped In a 18 Hole Plastic Tray
 Covers Black & Zinc Phillips
 Washer Head Trim Screws
 Contains 18 Different Sizes
 255 Total Pcs.
 Phillips Trim Screw Assortment
 Sold Each



# 8115 Door Trim Panel Retainer Assortment					
# 1646 Natural Nylon Door Trim Panel Retainers	# 9339 White Nylon Door Trim Panel Retainers	# 4020 Natural Nylon Door Trim Panel Retainers	# 592 Natural Nylon Door Trim Panel Retainers	# 9242 Natural Nylon Door Trim Panel Retainers	# 5264 White Nylon Door Trim Panel Retainers
# 1807 Natural Nylon Door Trim Panel Retainers	# 9368 Natural Nylon Door Trim Panel Retainers	# 1575 Black Nylon Door Trim Panel Retainers	# 2112 Black Nylon Door Trim Panel Retainers	# 1742 Natural Nylon Door Trim Panel Retainers	# 9373 Black Nylon Door Trim Panel Retainers















8115R (Refill Kit)
 Shipped In a 8" x 10" Plastic Bag
 Sold Each

12







8115 (Plastic Tray)
 Shipped In a 12 Hole Plastic Tray
 Covers G.M., Ford & AMC
 Model Cars & Trucks
 Contains 12 Different Sizes
 120 Total Pcs.
 Panel Retainer Assortment
 Sold Each



# 8116 G.M. Door Panel Pins & Grommets Assortment					
 19.5mm Top Head 30.4mm Pin Length Yellow Nylon Door Panel Pins Use with # 10470 & 10476	 19.5mm Top Head 30.4mm Pin Length Green Nylon Door Panel Pins Use with # 10470	 19.5mm Top Head 28.2mm Pin Length Black Nylon Door Panel Pins Use with # 10470	 19.5mm Top Head 28.2mm Pin Length White Nylon Door Panel Pins Use with # 10476	 13mm Top Head 25.5mm Pin Length White Nylon Door Panel Pins Use with # 10476	 19.5mm Top Head 30.4mm Pin Length Yellow Nylon Door Panel Pins Use with # 10470 & 10476
 9mm Hole Size Yellow Nylon Door Panel Nuts w/Sealer Use with # 10470, 10471	 9mm Hole Size Yellow Nylon Door Panel Nuts w/Sealer Use with # 10470, 10471	 9mm Hole Size White Nylon Door Panel Nuts w/Sealer Use with # 10470, 10472, 10473 & 10474	 9mm Hole Size White Nylon Door Panel Nuts w/Sealer Use with # 10470, 10472, 10473 & 10474	 9mm Hole Size White Nylon Door Panel Nuts w/Sealer Use with # 10470, 10472, 10473 & 10474	 9mm Hole Size White Nylon Door Panel Nuts w/Sealer Use with # 10470, 10472, 10473 & 10474

8116 (Plastic Tray)
 Shipped In a 12 Hole Plastic Tray
 Used on G.M. Cars & Trucks
 Contains 6 Different Sizes
 120 Total Pcs.
 Door Trim Panel Retainer Assortment
 Sold Each



# 8117 Shield Retainer Assortment					
 # 5625 1/4" (6.3mm) Hole Size Panel Range: .095" - .540" Black Nylon Shield Retainers	 # 9132 5/16" (7mm) Hole Size Panel Range: .125" - .315" Black Nylon Shield Retainers	 # JL-33 5/16" (7.5mm) Hole Size Panel Range: .075" - .495" Black Nylon Shield Retainers	 # 5643 23/64" (9mm) Hole Size Panel Range: .065" - .510" Black Nylon Shield Retainers	 # 5710 3/8" (9.5mm) Hole Size Panel Range: .115" - .565" Black Nylon Shield Retainers	 # 5648 23/64" (10mm) Hole Size Panel Range: .040" - .757" Black Nylon Shield Retainers



8117 (Plastic Tray)
 Shipped In a 6 Hole Plastic Tray
 Covers 6.3mm to 10mm Hole Size
 Black Nylon
 Contains 6 Different Sizes
 210 Total Pcs.
 Shield Retainer Assortment
 Sold Each

*Color Sales Brochures Available. Call for Details.



# 8118 Chrysler Door Panel Assortment					
10467	10466	10464	10465	10494	10477
9mm Top Head Dia. 19mm Flange Dia. White Nylon Door Panel Nut Use with # 10466	13mm Top Head Dia. 23mm Flange Dia. White Nylon Door Panel Retainer Use with # 10467	9.5mm Hole size 15mm Top Head Dia. 14mm Flange Dia. Yellow & White Nylon Door Panel Retainer	9.5mm Hole size 15mm Top Head Dia. 18mm Flange Dia. Gray & White Nylon Door Panel Retainer	9mm Hole size 16mm Top Head Dia. 15.4mm Flange Dia. White Nylon Door Panel Retainer	12.7mm Hole size 16mm Top Head Dia. 25mm Flange Dia. Natural Nylon Door Panel Retainer

8118 (Plastic Tray)
 Shipped In a 6 Hole Plastic Tray
 Covers Chrysler Cars & Trucks
 Contains 6 Different Sizes
 115 Total Pcs.
 Door Trim Panel Retainer Assortment
 Sold Each



# 8119 Shield & Push Type Retainer Assortment					
# 5625	# 9132	# JL-33	# 5643	# 5710	# 5648
1/4" (6.3mm) Hole Size Panel Range: .095" - .540" Black Nylon Shield Retainers	5/16" (7mm) Hole Size Panel Range: .125" - .310" Black Nylon Shield Retainers	5/16" (7.8mm) Hole Size Panel Range: .078" - .490" Black Nylon Shield Retainers	23/64" (9mm) Hole Size Panel Range: .060" - .510" Black Nylon Shield Retainers	3/8" (9.5mm) Hole Size Panel Range: .118" - .565" Black Nylon Shield Retainers	23/64" (10mm) Hole Size Panel Range: .040" - .787" Black Nylon Shield Retainers
# 5675	# 2128	# 1860	# 9327	# 9282	# 9382
1/4" (6.3mm) Hole Size Panel Range: 9/16" Black Nylon Mud Skirt Blind Rivets	5/16" (8mm) Hole Size Head Diameter: 20mm Stem Length: 11mm Black Nylon Front Fender Push-Type Retainers	5/16" (8mm) Hole Size Head Diameter: 20mm Stem Length: 20mm Black Nylon Air Baffle To Under Carriage Push-Type Retainers	23/64" (9mm) Hole Size Head Diameter: 18 mm Stem Length: 28 mm Black Nylon Rear Bumper Cover Push-Type Retainers	23/64" (10mm) Hole Size Head Diameter: 20mm Stem Length: 13mm Black Nylon Push-Type Retainers	23/64" (10mm) Hole Size Head Diameter: 20mm Stem Length: 18mm Black Nylon Push-Type Retainers



8119 (Plastic Tray)
 Shipped In a 12 Hole Plastic Tray
 Covers 6.3mm to 10mm Hole Size
 Black Nylon
 Contains 12 Different Sizes
 192 Total Pcs.
 Shield & Push Type Retainer Assortment
 Sold Each

*Color Sales Brochures Available. Call for Details.

12

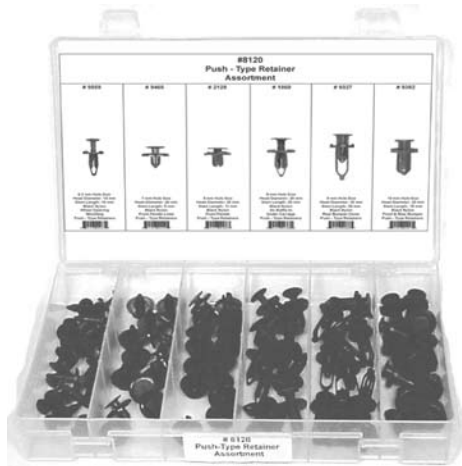

# 8120 Push-Type Retainer Assortment					
# 9559	# 9465	# 2128	# 1860	# 9327	# 9382
6.3mm Hole Size Head Diameter: 15mm Stem Length: 19mm Black Nylon Wheel Opening Moulding Push-Type Retainers	7mm Hole Size Head Diameter: 20mm Stem Length: 8mm Black Nylon Front Fender Liner Push-Type Retainers	8mm Hole Size Head Diameter: 20mm Stem Length: 11mm Black Nylon Front Fender Push-Type Retainers	8mm Hole Size Head Diameter: 20mm Stem Length: 20mm Black Nylon Air Baffle To Under Carriage Push Type Retainers	9 mm Hole Size Head Diameter: 18 mm Stem Length: 28 mm Black Nylon Rear Bumper Cover Push-Type Retainers	10 mm Hole Size Head Diameter: 20 mm Stem Length: 18 mm Black Nylon Front & Rear Bumper Push-Type Retainers

8120 (Plastic Tray)
 Shipped In a 6 Hole Plastic Tray
 Covers G.M., Ford, Chrysler,
 Honda & Toyota
 Contains 6 Different Sizes
 82 Total Pcs.
 Push Type Retainer Assortment
 Sold Each



8120R (Refill Kit)
 Shipped In a 8" x 10" Plastic Bag
 Sold Each



# 8121 Push-Type Retainer Assortment					
# 5675	# 2128	# 1860	# 9327	# 9282	# 9382
14" (6.3mm) Hole Size Panel Ramps: 9/16" Black Nylon Blind Rivets	5/16" (8mm) Hole Size Head Diameter: 20mm Stem Length: 11mm Black Nylon Front Fender Push-Type Retainers	5/16" (8mm) Hole Size Head Diameter: 20mm Stem Length: 20mm Black Nylon Air Baffle To Under Carriage Push Type Retainers	23/64" (8mm) Hole Size Head Diameter: 18 mm Stem Length: 28 mm Black Nylon Rear Bumper Cover Push-Type Retainers	23/64" (10mm) Hole Size Head Diameter: 20mm Stem Length: 13mm Black Nylon Push-Type Retainers	23/64" (10mm) Hole Size Head Diameter: 20mm Stem Length: 18mm Black Nylon Push-Type Retainers



8121 (Plastic Tray)
 Shipped In a 6 Hole Plastic Tray
 Covers 6.3mm to 10mm Hole Size
 Black Nylon
 Contains 6 Different Sizes
 175 Total Pcs.
 Push Type Retainer Assortment
 Sold Each

*Color Sales Brochures Available. Call for Details.

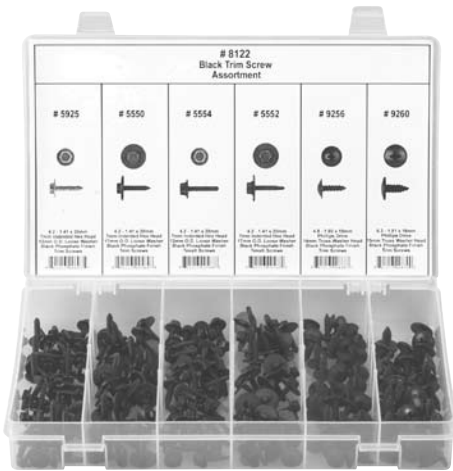

# 8122 Black Trim Screw Assortment					
# 5925	# 5550	# 5554	# 5552	# 9256	# 9260
4.2 - 1.41 x 20mm 7mm Indented Hex Head 12mm O.D. Loose Washer Black Phosphate Finish Trim Screws	4.2 - 1.41 x 20mm 7mm Indented Hex Head 17mm O.D. Loose Washer Black Phosphate Finish Trim Screws	4.2 - 1.41 x 20mm 7mm Indented Hex Head 12mm O.D. Loose Washer Black Phosphate Finish Teks® Screws	4.2 - 1.41 x 20mm 7mm Indented Hex Head 17mm O.D. Loose Washer Black Phosphate Finish Teks® Screws	4.8 - 1.60 x 15mm Phillips Drive 14mm Truss Washer Head Black Phosphate Finish Trim Screws	6.3 - 1.81 x 16mm Phillips Drive 15mm Truss Washer Head Black Phosphate Finish Trim Screws

8122 (Plastic Tray)
 Shipped In a 6 Hole Plastic Tray
 Hex Head & Phillips Drive
 Black Finish
 Contains 6 Different Sizes
 210 Total Pcs.
 Black Trim Screw Assortment
 Sold Each









# 8123 Phillips Pan Head Black Finish Sheet Metal Screw Assortment					
10101	10102	10103	10104	1623	1624
6 x 1/2" Phillips Pan Head Black Finish Sheet Metal Screws O.E.M. # N/A	6 x 3/4" Phillips Pan Head Black Finish Sheet Metal Screws O.E.M. # N/A	6 x 1" Phillips Pan Head Black Finish Sheet Metal Screws O.E.M. # N/A	6 x 1 1/4" Phillips Pan Head Black Finish Sheet Metal Screws O.E.M. # N/A	8 x 1/2" Phillips Pan Head Black Finish Sheet Metal Screws O.E.M. # N/A	8 x 3/4" Phillips Pan Head Black Finish Sheet Metal Screws O.E.M. # N/A
1625	1626	1722	1723	1724	1726
8 x 1" Phillips Pan Head Black Finish Sheet Metal Screws O.E.M. # N/A	8 x 1 1/2" Phillips Pan Head Black Finish Sheet Metal Screws O.E.M. # N/A	10 x 1/2" Phillips Pan Head Black Finish Sheet Metal Screws O.E.M. # N/A	10 x 3/4" Phillips Pan Head Black Finish Sheet Metal Screws O.E.M. # N/A	10 x 1" Phillips Pan Head Black Finish Sheet Metal Screws O.E.M. # N/A	10 x 1 1/2" Phillips Pan Head Black Finish Sheet Metal Screws O.E.M. # N/A

8123 (Plastic Tray)
 Shipped In a 12 Hole Plastic Tray
 Phillips Pan Head
 Black Finish
 Contains 12 Different Sizes
 420 Total Pcs.
 Black Sheet Metal Screw Assortment
 Sold Each













12



# 8125 Nylon Pop Rivet Assortment					
					
# 5769	# 1195	# 9054	# 1390	# 5775	# 5770
3/16" (5mm) Hole Size Panel Range: 1/8" - 15/64" Flange Size: 15/32" Black Nylon Pop Rivets	3/16" (5mm) Hole Size Panel Range: 15/64" - 25/64" Flange Size: 15/32" Black Nylon Pop Rivets	1/4" (6.3mm) Hole Size Panel Range: 3/32" - 3/16" Flange Size: 1/2" Black Nylon Pop Rivets	1/4" (6.3mm) Hole Size Panel Range: 5/32" - 13/32" Flange Size: 1/2" Black Nylon Pop Rivets	17/64" (6.6mm) Hole Size Panel Range: 3/32" - 3/16" Flange Size: 45/64" Black Nylon Pop Rivets	1/4" (6.3mm) Hole Size Panel Range: 5/32" - 13/32" Flange Size: 43/64" Black Nylon Pop Rivets

8125 (Plastic Tray)
 Shipped In a 6 Hole Plastic Tray
 Covers G.M., Ford & Chrysler
 Black Nylon
 Contains 6 Different Sizes
 115 Total Pcs.
 Nylon Pop Rivets Assortment
 Sold Each



# 8126 Hex Washer Head Tek Screw Assortment					
					
# 1077	# 1078	# 9791	# 9841	# 9346	# 1080
8 x 1/2" #2 Tek Point 1/4" Hex Head Indented Hex Washer Head Zinc Finish Tek® Screws	8 x 3/4" #2 Tek Point 1/4" Hex Head Indented Hex Washer Head Zinc Finish Tek® Screws	8 x 1" #2 Tek Point 1/4" Hex Head Indented Hex Washer Head Zinc Finish Tek® Screws	10 x 1/2" #2 Tek Point 3/16" Hex Head Indented Hex Washer Head Zinc Finish Tek® Screws	10 x 3/4" #2 Tek Point 5/16" Hex Head Indented Hex Washer Head Zinc Finish Tek® Screws	10 x 1" #2 Tek Point 5/16" Hex Head Indented Hex Washer Head Zinc Finish Tek® Screws
					
# 9794	# 9843	# 9795	# 1970	# 1971	# 9842
10 x 1 1/2" #3 Tek Point 5/16" Hex Head Indented Hex Washer Head Zinc Finish Tek® Screws	12 x 3/4" #3 Tek Point 5/16" Hex Head Indented Hex Washer Head Zinc Finish Tek® Screws	12 x 1" #3 Tek Point 5/16" Hex Head Indented Hex Washer Head Zinc Finish Tek® Screws	14 x 3/4" #3 Tek Point 3/8" Hex Head Indented Hex Washer Head Zinc Finish Tek® Screws	14 x 1" #3 Tek Point 3/8" Hex Head Indented Hex Washer Head Zinc Finish Tek® Screws	14 x 1 1/2" #2 Tek Point 3/8" Hex Head Indented Hex Washer Head Zinc Finish Tek® Screws

8126 (Plastic Tray)
 Shipped In a 12 Hole Plastic Tray
 Hex Washer Head Tek Screws
 Bright Zinc Finish
 Contains 12 Different Sizes
 295 Total Pcs.
 Hex Washer Head Tek Screw Assortment
 Sold Each



# 8127 Bright Zinc Finish Phillips Pan & Hex Washer Head Tek Screw Assortment					
 # 5765 8 x 1/2" 13/32" O.D. Washer Phillips Oval Washer Head	 # 1964 8 x 1/2" #2 Tek Point Phillips Pan Head	 # 1965 8 x 3/4" #2 Tek Point Phillips Pan Head	 # 1966 8 x 1" #2 Tek Point Phillips Pan Head	 # 1967 10 x 1/2" #2 Tek Point Phillips Pan Head	 # 1968 10 x 3/4" #2 Tek Point Phillips Pan Head
 # 1969 10 x 1" #2 Tek Point Phillips Pan Head	 # 1077 8 x 1/2" - 1/4" Hex Head #2 Tek Point Indented Hex Washer Head	 # 1078 8 x 3/4" - 1/4" Hex Head #2 Tek Point Indented Hex Washer Head	 # 9841 10 x 1/2" - 5/16" Hex Head #2 Tek Point Indented Hex Washer Head	 # 9346 10 x 3/4" - 5/16" Hex Head #2 Tek Point Indented Hex Washer Head	 # 1080 10 x 1" - 5/16" Hex Head #2 Tek Point Indented Hex Washer Head
 # 9843 12 x 3/4" - 5/16" Hex Head #3 Tek Point Indented Hex Washer Head	 # 9795 12 x 1" - 5/16" Hex Head #3 Tek Point Indented Hex Washer Head	 # 1970 14 x 3/4" - 3/8" Hex Head #3 Tek Point Indented Hex Washer Head	 # 1971 14 x 1" - 3/8" Hex Head #3 Tek Point Indented Hex Washer Head	 # 9797 14 x 1 1/4" - 3/8" Hex Head #3 Tek Point Indented Hex Washer Head	 # 9842 14 x 1 1/2" - 3/8" Hex Head #3 Tek Point Indented Hex Washer Head

8127 (Plastic Tray)
 Shipped In a 18 Hole Plastic Tray
 Phillips Pan & Hex Washer Head
 Black & Bright Zinc Finish
 Contains 18 Different Sizes
 425 Total Pcs.
 Tek Screw Assortment
 Sold Each



# 8130 Phillips Oval Head Screw Assortment					
 # 6400 8 x 1/2" # 6 Head Phillips Oval Head Chrome Finish Sheet Metal Screws	 # 6401 8 x 3/4" # 6 Head Phillips Oval Head Chrome Finish Sheet Metal Screws	 # 6402 8 x 1" # 6 Head Phillips Oval Head Chrome Finish Sheet Metal Screws	 # 6404 8 x 1 1/2" # 6 Head Phillips Oval Head Chrome Finish Sheet Metal Screws	 # 6410 10 x 3/4" # 8 Head Phillips Oval Head Chrome Finish Sheet Metal Screws	 # 6411 10 x 1" # 8 Head Phillips Oval Head Chrome Finish Sheet Metal Screws
 # 9479 8 x 1/2" # 6 Head Phillips Oval Head Black Finish Sheet Metal Screws	 # 1184 8 x 3/4" # 6 Head Phillips Oval Head Black Finish Sheet Metal Screws	 # 1186 8 x 1" # 6 Head Phillips Oval Head Black Finish Sheet Metal Screws	 # 1188 8 x 1 1/2" # 6 Head Phillips Oval Head Black Finish Sheet Metal Screws	 # 9480 10 x 3/4" # 8 Head Phillips Oval Head Black Finish Sheet Metal Screws	 # 9252 10 x 1" # 8 Head Phillips Oval Head Black Finish Sheet Metal Screws

8130 (Plastic Tray)
 Shipped In a 12 Hole Plastic Tray
 Phillips Oval Head
 Black & Chrome Finish
 Contains 12 Different Sizes
 380 Total Pcs.
 Phillips Oval Head Screw Assortment
 Sold Each



8130R (Refill Kit)
 Shipped In a 8" x 10" Plastic Bag
 Sold Each

12



# 8131 Bright Zinc Finish Cotter Pin Assortment					
4067	4074	4086	4088	4090	4094
1/16" x 2" Zinc Finish Hammerlock Type Cotter Pins	3/32" x 2" Zinc Finish Hammerlock Type Cotter Pins	1/8" x 1" Zinc Finish Hammerlock Type Cotter Pins	1/8" x 1 1/2" Zinc Finish Hammerlock Type Cotter Pins	1/8" x 2" Zinc Finish Hammerlock Type Cotter Pins	5/32" x 1" Zinc Finish Hammerlock Type Cotter Pins
4096	4098	4103	4105	4107	4114
5/32" x 1 1/2" Zinc Finish Hammerlock Type Cotter Pins	5/32" x 2" Zinc Finish Hammerlock Type Cotter Pins	3/16" x 1" Zinc Finish Hammerlock Type Cotter Pins	3/16" x 1 1/2" Zinc Finish Hammerlock Type Cotter Pins	3/16" x 2" Zinc Finish Hammerlock Type Cotter Pins	1/4" x 1 1/2" Zinc Finish Hammerlock Type Cotter Pins

8131 (Plastic Tray)
 Shipped In a 12 Hole Plastic Tray
 Hammerlock Type
 Bright Zinc Finish
 Contains 12 Different Sizes
 375 Total Pcs.
 Cotter Pin Assortment
 Sold Each







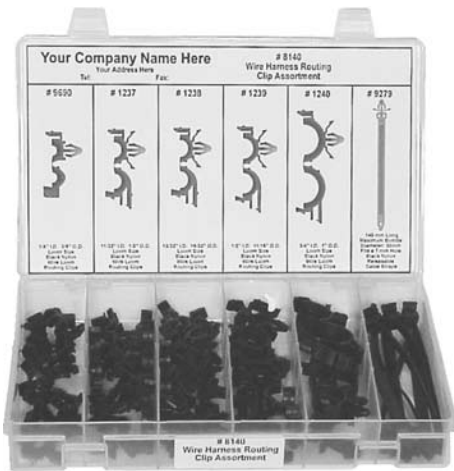

# 8135 Shield Retainer Assortment					
# JL-32	# 1583	# 5506	# 5625	# 5632	# 5627
3/16" (4.5mm) Hole Size Panel Range: .125" - .310" Black Nylon Shield Retainers	3/16" (5mm) Hole Size Panel Range: .090" - .570" Black Nylon Shield Retainers	1/4" (6.4mm) Hole Size Panel Range: .110" - .460" Black Nylon Shield Retainers	1/4" (6.4mm) Hole Size Panel Range: .095" - .540" Black Nylon Shield Retainers	1/4" (6.4mm) Hole Size Panel Range: .070" - .590" Black Nylon Shield Retainers	1/4" (6.4mm) Hole Size Panel Range: .100" - .685" Black Nylon Shield Retainers
# 9132	# JL-33	# 5995	# 5643	# 5710	# 5648
9/32" (7.1mm) Hole Size Panel Range: .125" - .310" Black Nylon Shield Retainers	5/16" (7.8mm) Hole Size Panel Range: .070" - .490" Black Nylon Shield Retainers	5/16" (7.8mm) Hole Size Panel Range: .060" - 1.025" Black Nylon Shield Retainers	23/64" (9mm) Hole Size Panel Range: .060" - .510" Black Nylon Shield Retainers	3/8" (9.5mm) Hole Size Panel Range: .115" - .565" Black Nylon Shield Retainers	25/64" (10mm) Hole Size Panel Range: .340" - .787" Black Nylon Shield Retainers

8135 (Plastic Tray)
 Shipped In a 12 Hole Plastic Tray
 Covers 3/16" to 25/64" Hole Size
 Black Nylon
 Contains 12 Different Sizes
 168 Total Pcs.
 Shield Retainer Assortment
 Sold Each



8135R (Refill Kit)
 Shipped In a 8" x 10" plastic bag
 Sold Each















# 8140 Wire Harness Routing Clip Assortment					
<p># 9690</p>  <p>1/4" I.D. 3/8" O.D. Loom Size Black Nylon Wire Loom Routing Clips</p>	<p># 1237</p>  <p>11/32" I.D. 1/2" O.D. Loom Size Black Nylon Wire Loom Routing Clips</p>	<p># 1238</p>  <p>13/32" I.D. 19/32" O.D. Loom Size Black Nylon Wire Loom Routing Clips</p>	<p># 1239</p>  <p>1/2" I.D. 11/16" O.D. Loom Size Black Nylon Wire Loom Routing Clips</p>	<p># 1240</p>  <p>3/4" I.D. 1" O.D. Loom Size Black Nylon Wire Loom Routing Clips</p>	<p># 9279</p>  <p>140 mm Long Maximum Bundle Diameter: 30mm Fits a 7 mm Hole Black Nylon Releaseable Cable Straps</p>

8140 (Plastic Tray)
 Shipped In a 6 Hole Plastic Tray
 Covers 3/8" to 3/4" Loom
 Black Nylon
 Contains 6 Different Sizes
 54 Total Pcs.
 Wire Routing Clip Assortment
 Sold Each



8140R (Refill Kit)
 Shipped In a 8" x 10" plastic bag
 Sold Each



# 8145 Thread Cutting Nuts & Push On Retainer Assortment					
<p># 989</p>  <p>1/4" Bolt Size 25/32" Flange O.D. Zinc Finish Push On Retainers</p>	<p># 991</p>  <p>1/2" Bolt Size 15/16" O.D. Black Finish Push On Retainers</p>	<p># 1621</p>  <p>6 - 1.00 mm Screw Size 17 mm Flange O.D. Black Finish Push On Retainers</p>	<p># 3010</p>  <p>8 - 1.25 mm Screw Size 24 mm Flange O.D. Black Finish Push On Retainers</p>	<p># 1276</p>  <p>10 - 1.50 mm Screw Size 24 mm Flange O.D. Dacromet Finish Push On Retainers</p>	<p># 1044</p>  <p>12-1.75mm Bolt Size 21mm Flange O.D. Black Finish Push On Retainers</p>
<p># 265</p>  <p>1/8" Stud Size 5/16" Hex Size 17/32" Flange Zinc Finish Thread Cutting Nuts</p>	<p># 263</p>  <p>3/16" Stud Size 3/8" Hex Size 5/8" Flange Zinc Finish Thread Cutting Nuts</p>	<p># 9226</p>  <p>1/4" Stud Size 7/16" Hex Size 11/16" Flange Zinc Finish Thread Cutting Nuts</p>	<p># 856</p>  <p>5/16" Stud Size 1/2" Hex Size 7/8" Flange Zinc Finish Thread Cutting Nuts</p>	<p># 1042</p>  <p>6.3 mm Stud Size 11mm Hex Size 18mm Flange Zinc Finish Thread Cutting Nuts</p>	<p># 1622</p>  <p>8mm Stud Size 13mm Hex Size 20mm Flange Zinc Finish Thread Cutting Nuts</p>

8145 (Plastic Tray)
 Shipped In a 12 Hole Plastic Tray
 Thread Cutting Nut &
 Push on Retainers
 Contains 12 Different Sizes
 245 Total Pcs.
 Thread Cutting Nut & Push on
 Retainer Assortment
 Sold Each



8145R (Refill Kit)
 Shipped In a 8" x 10" plastic bag
 Sold Each

12



# 8146 Ford Door Trim Panel Retainer Assortment					
# 2112	# 1558	# 9514	# 1024	# 1648	# 10544
17/64" (7mm) Hole Size Top Head Dia.: 12.5mm Stem Length: 19mm Black Nylon Door Trim Panel Retainers	17/64" (7mm) Hole Size Top Head Dia.: 13.2mm Stem Length: 19mm Natural Nylon Door Trim Panel Retainers	17/64" (7mm) Hole Size Top Head Dia.: 13mm Stem Length: 22mm Natural Nylon Door Trim Panel Retainers	17/64" (7mm) Hole Size Top Head Dia.: 20mm Stem Length: 18.5mm Natural Nylon Door Trim Panel Retainers	17/64" (7mm) Hole Size Top Head Dia.: 20mm Stem Length: 24mm Natural Nylon Door Trim Panel Retainers	17/64" (7mm) Hole Size Top Head Dia.: 15mm Stem Length: 13mm Natural Nylon Door Trim Panel Retainers
# 9372	# 10098	# 1575	# 1742	# 10612	# 10667
5/16" (8mm) Hole Size Top Head Dia.: 1/2" Stem Length: 21/32" Natural Nylon Door Trim Panel Retainers	5/16" (7.9mm) Hole Size Top Head Dia.: 1/2" Stem Length: 3/4" Yellow Nylon Door Trim Panel Retainers	5/16" (8mm) Hole Size Top Head Dia.: 1/2" Stem Length: 3/4" Black Nylon Door Trim Panel Retainers	5/16" (8mm) Hole Size Top Head Dia.: 1/2" Stem Length: 1" Natural Nylon Door Trim Panel Retainers	(9mm) Hole Size Top Head Dia.: 16mm Stem Length: 17mm White Nylon With Sealer Door Trim Panel Retainers	(10mm) Hole Size Top Head Dia.: 15mm Stem Length: 19.5mm Natural Nylon Door Trim Panel Retainers

8146 (Plastic Tray)
 Shipped In a 12 Hole Plastic Tray
 Covers Ford Cars & Trucks
 Nylon
 Contains 12 Different Sizes
 116 Total Pcs.
 Door Trim Panel Retainer Assortment
 Sold Each



# 8150 Weatherstrip Retainer Assortment					
# 1991	# 9264	# 2016	# 9560	# 9208	# 5602
4.5mm Hole Size Stem Length: 11mm Head Dia.: 4.8 x 13.5mm Black Nylon Weatherstrip Retainers	5mm Hole Size Stem Length: 14.5mm Head Dia.: 5.5 x 14.5mm Black Nylon Weatherstrip Retainers	5mm Hole Size Stem Length: 15mm Head Dia.: 6.5 x 16.5mm White Nylon Weatherstrip Retainers	5mm Hole Size Stem Length: 10mm Head Dia.: 7 x 16mm White Nylon Weatherstrip Retainers	6mm Hole Size Stem Length: 10mm Head Dia.: 5 x 15mm Orange Nylon Weatherstrip Retainers	4mm Hole Size Head Diameter: 9mm Stem Length: 10.7mm Black Nylon Retaining Clips
# 5605	# JL-32	# 8172	# 1996	# 5609	# 9262
4.5mm Hole Size Head Diameter: 11mm Stem Length: 8.3mm Black Nylon Weatherstrip Retainers	4.5mm Hole Size Head Diameter: 9.3mm Stem Length: 13.5mm Black Nylon Weatherstrip Retainers	4.5mm Hole Size Head Diameter: 11mm Stem Length: 16mm Black Nylon Retaining Clips	5mm Hole Size Head Diameter: 13mm Stem Length: 11mm Black Nylon Retaining Clips	5.3mm Hole Size Head Diameter: 10mm Stem Length: 15.5mm Black Nylon Retaining Clips	6mm Hole Size Head Diameter: 12mm Stem Length: 9mm Black Nylon Retaining Clips

8150 (Plastic Tray)
 Shipped In a 12 Hole Plastic Tray
 Covers G.M., Ford, Chrysler,
 Honda & Toyota
 Contains 12 Different Sizes
 300 Total Pcs.
 Weatherstrip Retainer Assortment
 Sold Each































8150R (Refill Kit)
 Shipped In a 8" x 10" plastic bag
 Sold Each



# 8155 Stainless Steel Capped Bumper Bolt Assortment					
# 240	# 855	# 9314	# 233	# 231	# 9275
					
5/16-18 x 1" 3/4" Head Diameter Round Style Head Stainless Steel Capped Bumper Bolts	3/8-16 X 1" 7/8" Head Diameter Pan Head Stainless Steel Capped Bumper Bolts	3/8-16 x 1 1/4" 7/8" Head Diameter Round Style Head Stainless Steel Capped Bumper Bolts	7/16-14 x 1 1/2" 29/32" Head Diameter Round Style Head Stainless Steel Capped Bumper Bolts	1/2-13 x 1 1/2" 1 3/32" Head Diameter Round Style Head Stainless Steel Capped Bumper Bolts	8-1.25 x 25mm 12.7mm Head Diameter Pan Head Stainless Steel Capped Bumper Bolts
					

8155 (Plastic Tray)
 Shipped In a 6 Hole Plastic Tray
 Covers 5/16" to 1/2"
 Stainless Steel Capped
 Contains 6 Different Sizes
 53 Total Pcs.
 Bumper Bolt Assortment
 Sold Each



# 8161 Universal Door Pin & Bushing Assortment						
9164		9825				
						
1 1/32" Pin Dia. 5 1/4" Length Stainless Steel Door Hinge Pins		1 1/32" Dia. Length: 4 1/8" Hg. O.D.: 3" Door Hinge Pins				
						
3/45" I.D. .485" O.D. 365" Hg. Hinge Pin Bushings Use with # 9164PK	3/8" I.D. 475" O.D. 295" Hg. Hinge Pin Bushings	3/8" I.D. 475" O.D. 295" Hg. Hinge Pin Bushings	3/45" I.D. 419" O.D. 365" Hg. Hinge Pin Bushings	1 1/32" Dia. 3 1/2" Long 916" Hg. Dia. Door Hinge Pins	1 1/32" Dia. Length: 3 3/8" Hg. O.D.: 916" Door Hinge Pins	1 1/32" Dia. Length: 4" Hg. O.D.: 715" Door Hinge Pins
						
						
3/8" I.D. 535" O.D. 365" Hg. Hinge Pin Bushings Use with # 9164PK	3/8" I.D. 475" O.D. 295" Hg. Hinge Pin Bushings	3/45" I.D. 485" O.D. 365" Hg. Hinge Pin Bushings	1 1/32" Dia. 3 1/2" Long 916" Hg. Dia. Door Hinge Pins		1 1/32" Dia. Length: 4" Hg. O.D.: 715" Door Hinge Pins	1 1/32" Dia. Length: 4 1/4" Hg. O.D.: 716" Door Hinge Pins
						

8161 (Plastic Tray)
 Shipped In a 10 Hole Plastic Tray
 Covers G.M. & Ford
 Includes Bushings & Retainers
 Contains 6 Different Sizes
 86 Total Pcs.
 Door Pin & Bushing Assortment
 Sold Each

12



# 8165 Flush Type Hole Plug Assortment					
# 9812 1/4" Hole Size Black Flush Type Hole Plugs	# 1302 3/8" Hole Size Black Flush Type Hole Plugs	# 1091 1/2" Hole Size Black Flush Type Hole Plugs	# 1379 3/4" Hole Size Black Flush Type Hole Plugs	# 2051 1/4" Hole Size Black Flush Type Locking Hole Plugs	# 2053 3/8" Hole Size Black Flush Type Locking Hole Plugs
# 9827 1/4" Hole Size White Flush Type Hole Plugs	# 9828 3/8" Hole Size White Flush Type Hole Plugs	# 9829 1/2" Hole Size White Flush Type Hole Plugs	# 9830 3/4" Hole Size White Flush Type Hole Plugs	# 2225 1/2" Hole Size Black Flush Type Locking Hole Plugs	# 9831 3/4" Hole Size Black Flush Type Locking Hole Plugs



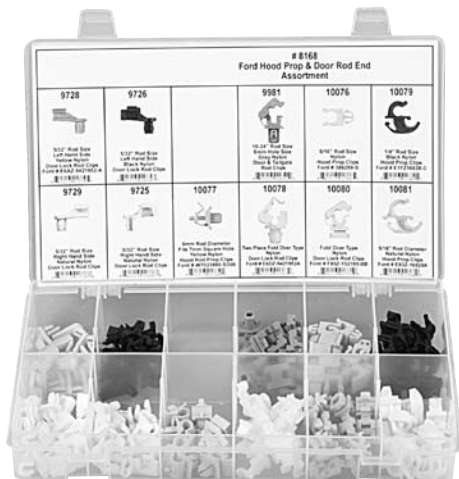





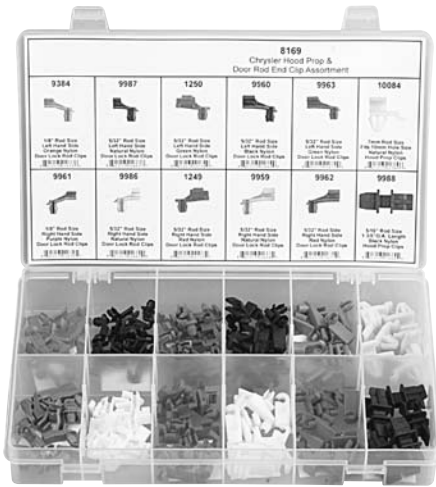



8165 (Plastic Tray)
 Shipped In a 12 Hole Plastic Tray
 Covers All Types Of Flush Hole Plugs
 White & Black Nylon
 Contains 12 Different Sizes
 349 Total Pcs.
 Flush Type Hole Plug Assortment
 Sold Each



# 8168 Ford Hood Prop & Door Rod End Assortment					
9728 5/32" Rod Size Left Hand Side Yellow Nylon Door Lock Rod Clips Ford # E6AZ-5421952-A	9726 5/32" Rod Size Left Hand Side Black Nylon Door Lock Rod Clips	9981 10-24" Rod Size Gray Nylon Door & Tailgate Rod Clips	10076 5/16" Rod Size Nylon Hood Prop Clips Ford # 386299-S	10079 1/4" Rod Size Black Nylon Hood Prop Clips Ford # E1FZ16828-C	
9729 5/32" Rod Size Right Hand Side Natural Nylon Door Lock Rod Clips	9725 5/32" Rod Size Right Hand Side Black Nylon Door Lock Rod Clips	10077 6mm Rod Diameter Fits 7mm Square Hole Yellow Nylon Hood Rod Prop Clips Ford # W7023880-S300	10078 Two Piece Fold Over Type Nylon Door Lock Rod Clips Ford # E50Z-5421952A	10080 Fold Over Type Nylon Door Lock Rod Clips Ford # F85Z-152195-BB	10081 5/16" Rod Diameter Natural Nylon Hood Prop Clips Ford # E53Z-16528A







8168 (Plastic Tray)
 Shipped In a 12 Hole Plastic Tray
 Covers Ford Cars & Trucks
 All Nylon
 Contains 11 Different Sizes
 100 Total Pcs.
 Hood Prop & Rod End Assortment
 Sold Each

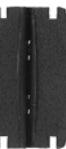

8169 Chrysler Hood Prop & Door Rod End Clip Assortment					
 9384 1/8" Rod Size Left Hand Side Orange Nylon Door Lock Rod Clips	 9987 5/32" Rod Size Left Hand Side Natural Nylon Door Lock Rod Clips	 1250 5/32" Rod Size Left Hand Side Green Nylon Door Lock Rod Clips	 9960 5/32" Rod Size Left Hand Side Black Nylon Door Lock Rod Clips	 9963 5/32" Rod Size Left Hand Side Green Nylon Door Lock Rod Clips	 10084 Fits 10mm Hole Size Natural Nylon Hood Prop Clips
 9961 1/8" Rod Size Right Hand Side Purple Nylon Door Lock Rod Clips	 9986 5/32" Rod Size Right Hand Side Natural Nylon Door Lock Rod Clips	 1249 5/32" Rod Size Right Hand Side Red Nylon Door Lock Rod Clips	 9959 5/32" Rod Size Right Hand Side Natural Nylon Door Lock Rod Clips	 9962 5/32" Rod Size Right Hand Side Red Nylon Door Lock Rod Clips	 9988 5/16" Rod Size 1 3/8" O.A. Length Black Nylon Hood Prop Clips

8169 (Plastic Tray)
 Shipped In a 12 Hole Plastic Tray
 Covers Chrysler Cars & Trucks
 All Nylon
 Contains 12 Different Sizes
 131 Total Pcs.
 Hood Prop & Rod End Assortment
 Sold Each



8170 Window Guide Retainers Assortment					
 # 1568 Black Nylon Front Door Glass Window Guide Retainers	 # 1563 Upper Part of Glass Black Nylon Front Door Glass Window Guide Retainers	 # 1562 Black Nylon Front & Rear Door Glass Window Guide Retainers	 # 1566 Rear of Glass Black Nylon Front Door Glass Window Guide Retainers	 # 9421 Front of Glass 4mm Thick Black Nylon Front Door Glass Window Guide Retainers	 # 1681 Black Nylon Front Door Glass Window Guide Retainers

8170 (Plastic Tray)
 Shipped In a 6 Hole Plastic Tray
 Covers G.M. Cars
 Black Nylon
 Contains 6 Different Sizes
 42 Total Pcs.
 Window Guide Assortment
 Sold Each

12

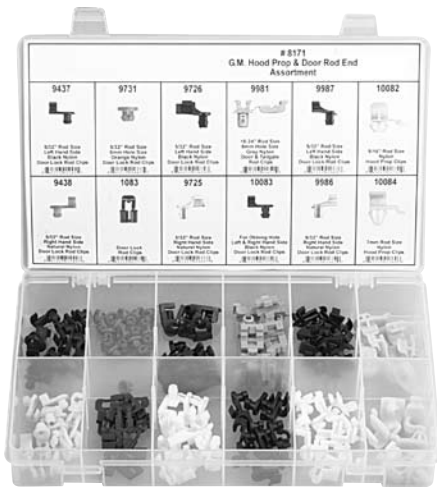

# 8171 G.M. Hood Prop & Door Rod End Assortment					
 9437 5/32" Rod Size Left Hand Side Black Nylon Door Lock Rod Clips	 9731 5/32" Rod Size 6mm Hole Size Orange Nylon Door Lock Rod Clips	 9726 5/32" Rod Size Left Hand Side Black Nylon Door Lock Rod Clips	 9981 10-24" Rod Size 8mm Hole Size Yellow Nylon Door & Tailgate Rod Clips	 9987 5/32" Rod Size Left Hand Side Black Nylon Door Lock Rod Clips	 10082 5/16" Rod Size Nylon Hood Prop Clips
 9438 5/32" Rod Size Right Hand Side Natural Nylon Door Lock Rod Clips	 1083 Door Lock Rod Clips	 9725 5/32" Rod Size Right Hand Side Natural Nylon Door Lock Rod Clips	 10083 For Oblong Hole Left & Right Hand Side Black Nylon Door Lock Rod Clips	 9986 5/32" Rod Size Right Hand Side Natural Nylon Door Lock Rod Clips	 10084 7mm Rod Size Nylon Hood Prop Clips

8171 (Plastic Tray)
 Shipped In a 12 Hole Plastic Tray
 Covers G.M. Cars & Trucks
 Nylon & Metal Retainers
 Contains 12 Different Sizes
 137 Total Pcs.
 Hood Prop & Rod End Assortment
 Sold Each



# 8173 Toyota & Lexus Moulding Clip Assortment					
 9946 Hole Size: 9mm Head Diameter: 17mm Red Nylon Fender Moulding Clips	 10112 Hole Size: 9mm Head Diameter: 17mm Yellow Nylon Fender & Wheel Flare Moulding Clip	 10492 Hole Size: 9mm Head Diameter: 17mm Orange Nylon Wheel Flare Moulding Clips With Sealer	 10113 Hole Size: 9mm Head Diameter: 17mm Blue Nylon Fender Moulding Clips	 10392 Hole Size: 9mm Head Diameter: 18mm White Nylon Rocker Panel Moulding Clips	 10490 Hole Size: 10mm Head Diameter: 17mm Blue Nylon Rocker Panel Moulding Clips With Sealer
 10397 Hole Size: 8mm Head Diameter: 18mm Yellow Nylon Fender Moulding Clips With Sealer	 10396 Hole Size: 8mm Head Diameter: 18mm Gray Nylon Fender Moulding Clips With Sealer	 10493 Hole Size: 9mm Head Diameter: 18mm Pink Nylon Moulding Clips With Sealer	 10491 Hole Size: 12mm Head Diameter: 18mm Gray Nylon Rocker Panel Moulding Clips	 10394 Hole Size: 9 x 12mm Head Diameter: 20mm White Nylon Garnish Moulding Clips	



8173 (Plastic Tray)
 Shipped In a 12 Hole Plastic Tray
 Covers 8mm to 10mm Hole Size
 Covers Toyota & Lexus
 Contains 11 Different Sizes
 154 Total Pcs.
 Moulding Clip Assortment
 Sold Each

*Color Sales Brochures Available. Call for Details.



# 8174 Toyota Retainer Assortment					
# 9081 9mm Hole Size White Nylon Door Trim Panel Retainers	# 1603 7mm Hole Size Black Nylon Push-Type Retainers	# 9465 7mm Hole Size Black Nylon Front Fender Liner Push-Type Retainers	# 9327 9mm Hole Size Black Nylon Rear Bumper Cover Push-Type Retainers	# 1996 5mm Hole Size Black Nylon Retaining Clips	# 1950 7mm Hole Size Black Nylon Retaining Clips
# 1614 10 Screw Size Natural Nylon Screw Grommets Fits a 8.5mm Square Hole	# 1560 10 Screw Size Natural Nylon Headlamp Bezel & Grille Nuts	# 1576 10 Screw Size Natural Nylon Screw Grommets	# 9591 8 Screw Size 7mm Square Hole Natural Nylon Screw Grommets	# 9912 #12 Screw Size 10mm Square Hole Front & Rear Wheel Fender Liner Screw Grommets	# 1605 1/4" (#14) Screw Size Black Nylon Screw Grommets

8174 (Plastic Tray)
Shipped In a 12 Hole Plastic Tray
Covers Toyota Cars
All Nylon
Contains 12 Different Sizes
146 Total Pcs.
Retainer Assortment
Sold Each



8174R (Refill Kit)
Shipped In a 8" x 10" plastic bag
Sold Each



# 8175 Nissan Retainer Assortment					
# 1756 6mm Square Hole Size Head Size: 8mm x 12mm Stem Length: 8mm Black Nylon Cowl Grille Retainers	# 2028 6mm Hole Size Head Dia.: 14mm Stem Length: 16mm Black Nylon Cowl Panel to Reinf. Plate & Engine Splash Shield Retainers	# 9114 7mm Hole Size Head Diameter: 18mm Stem Length: 11mm Black Nylon Push-Type Retainers	# 1949 8mm Hole Size Head Diameter: 20mm Stem Length: 15mm Black Nylon Front & Rear Bumper Cover Push-Type Retainers	# 9540 8mm Hole Size Head Diameter: 20mm Stem Length: 9mm Black Nylon Push-Type Retainers	# 1975 8mm Hole Size Head Diameter: 16mm Stem Length: 20mm Black Nylon Push-Type Retainers
# 5901 5/16" (8mm) Hole Size Stem Length: 18mm Flange Size: 20mm Black Nylon Inter Fender Shield Blind Rivets	# 9294 10mm Hole Size Head Diameter: 18mm Stem Length: 15mm Black Nylon Push-Type Retainers	# 2153 11mm Hole Size Head Diameter: 22mm Stem Length: 14mm Black Nylon Bumper & Fascia Push-Type Retainers	# 9539 Natural Nylon Door Trim Panel Retainers	# 1634 6mm Hole Size Head Diameter: 14mm Stem Length: 16mm Black Nylon Retaining Clips	# 2025 Stem Length: 9mm Outside Dia.: 38mm Black Nylon Hood Insulation Clips

8175 (Plastic Tray)
Shipped In a 12 Hole Plastic Tray
Covers Nissan Cars
All Nylon
Contains 12 Different Sizes
123 Total Pcs.
Retainer Assortment
Sold Each



8175R (Refill Kit)
Shipped In a 8" x 10" plastic bag
Sold Each



# 8176 Wide Range "U" Nuts Assortment					
# 1350	# 5750	# 5751	# 5752	# 1192	# 5753
8 Screw Size Panel Range: .020" - .150" Center of Hole to Edge: .318" Black Phosphate Finish Wide Range "U" Nuts	8 Screw Size Panel Range: .025" - .150" Center of Hole to Edge: .518" Black Phosphate Finish Wide Range "U" Nuts	10 Screw Size Panel Range: .025" - .150" Center of Hole to Edge: .318" Black Phosphate Finish Wide Range "U" Nuts	10 Screw Size Panel Range: .025" - .150" Center of Hole to Edge: .518" Black Phosphate Finish Wide Range "U" Nuts	14 Screw Size Panel Range: .025" - .150" Center of Hole to Edge: .318" Black Phosphate Finish Wide Range "U" Nuts	14 Screw Size Panel Range: .025" - .150" Center of Hole to Edge: .518" Black Phosphate Finish Wide Range "U" Nuts

8176 (Plastic Tray)
 Shipped In a 6 Hole Plastic Tray
 For #8,10 & 1/4" Screws
 Short & Long Type
 Contains 6 Different Sizes
 210 Total Pcs.
 "U" Nut Assortment
 Sold Each



# 8177 Honda Retainer Assortment					
# D-123	# D-124	# 9202	# 1973	# 1976	# 9208
10mm Hole Size Stem Length: 27mm Flange Size: 20mm Black Nylon Bumper Fascia Retainers	10mm Hole Size Stem Length: 24mm Flange Size: 20mm Black Nylon Bumper Fascia Retainers	10mm Hole Size Stem Length: 15mm Head Diameter: 20mm Black Nylon Push-Type Retainers	8mm Hole Size Stem Length: 21mm Head Diameter: 18mm Black Nylon Push-Type Retainers	8mm Hole Size Head Diameter: 20mm Stem Length: 8mm Black Nylon Push-Type Retainers	6mm Hole Size Stem Length: 10mm Head Dia.: 2 x 15mm Orange Nylon Weatherstrip Retainers
# 9282	# 2060	# 2128	# 9382	# 9262	# 9945
10mm Hole Size Head Diameter: 20mm Stem Length: 13mm Black Nylon Push-Type Retainers	10mm Hole Size Head Diameter: 25mm Stem Length: 11mm Black Nylon Push-Type Retainers	8mm Hole Size Head Diameter: 20mm Stem Length: 18mm Black Nylon Push-Type Retainers	10mm Hole Size Head Diameter: 20mm Stem Length: 18mm Black Nylon Push-Type Retainers	8mm Hole Size Head Diameter: 12mm Stem Length: 9mm Black Nylon Retaining Clips	7.5mm Hole Size Head Diameter: 30mm Black Nylon Hood Insulation Clips

8177 (Plastic Tray)
 Shipped In a 12 Hole Plastic Tray
 Covers Honda Cars
 Black Nylon
 Contains 12 Different Sizes
 121 Total Pcs.
 Retainer Assortment
 Sold Each



8177R (Refill Kit)
 Shipped In a 8" x 10" plastic bag
 Sold Each



# 8178 Air Cleaner Hold Down Wing Nut Assortment					
10245	10243	10244	10242	10240	10241
1/4"-20 Thread Size Black Nylon Air Cleaner Hold Down Wing Nuts	1/4"-20 Thread Size Natural Nylon Air Cleaner Hold Down Wing Nuts	1/4"-20 Thread Size Zinc Finish Air Cleaner Hold Down Wing Nuts	1/4"-20 x 1" Thread Size Zinc Finish Air Cleaner Hold Down Wing Nuts	1/4"-20 Thread Size Yellow Zinc Finish Air Cleaner Hold Down Wing Nuts	8-1.25mm Thread Size Zinc Finish Air Cleaner Hold Down Wing Nuts

8178 (Plastic Tray)
 Shipped In a 6 Hole Plastic Tray
 Covers 1/4"-20 & 6-1.00mm Thread Sizes
 Metal & Nylon
 Contains 6 Different Sizes
 60 Total Pcs.
 Air Cleaner Wing Nut Assortment
 Sold Each

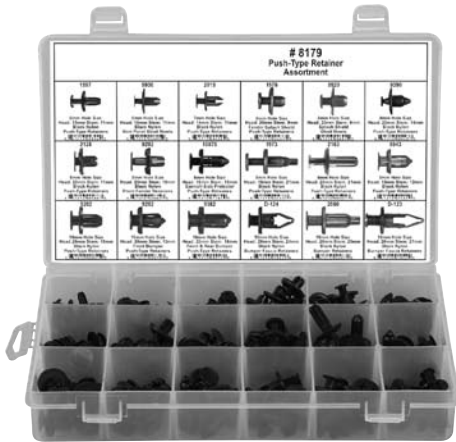

# 8179 Push-Type Retainer Assortment					
1597	5930	2015	1976	5920	9390
6mm Hole Size Head: 15mm Stem: 11mm Black Nylon Push-Type Retainers	6mm Hole Size Head: 18mm Stem: 11mm Black Nylon Vent Panel Blind Rivets	7mm Hole Size Head: 14mm Stem: 11mm Black Nylon Push-Type Retainers	8mm Hole Size Head: 20mm Stem: 9mm Fender Splash Shield Push-Type Retainers	8mm Hole Size Head: 20mm Stem: 9mm Splash Shield Blind Rivets	8mm Hole Size Head: 20mm Stem: 14mm Black Nylon Push-Type Retainers
2128	9292	10075	1973	2163	9943
8mm Hole Size Head: 20mm Stem: 11mm Black Nylon Push-Type Retainers	8mm Hole Size Head: 20mm Stem: 10mm Black Nylon Front Fender Retainers	8mm Hole Size Head: 18mm Stem: 15mm Garage Side Protector Push-Type Retainers	8mm Hole Size Head: 18mm Stem: 21mm Black Nylon Push-Type Retainers	8mm Hole Size Head: 20mm Stem: 21mm Black Nylon Push-Type Retainers	8mm Hole Size Head: 18mm Stem: 12mm Black Nylon Push-Type Retainers
9202	9282	9382	D-124	2060	D-123
10mm Hole Size Head: 20mm Stem: 15mm Black Nylon Push-Type Retainers	10mm Hole Size Head: 20mm Stem: 13mm Front Bumper Push-Type Retainers	10mm Hole Size Head: 20mm Stem: 18mm Front & Rear Bumper Push-Type Retainers	10mm Hole Size Head: 20mm Stem: 24mm Black Nylon Bumper Fascia Retainers	10mm Hole Size Head: 20mm Stem: 25mm Black Nylon Bumper Retainers	10mm Hole Size Head: 20mm Stem: 27mm Black Nylon Bumper Fascia Retainers

8179 (Plastic Tray)
 Shipped In a 18 Hole Plastic Tray
 Covers 6mm to 10mm Hole Size
 Honda & Acura Cars
 Contains 18 Different Sizes
 164 Total Pcs.
 Push Type Retainer Assortment
 Sold Each

12

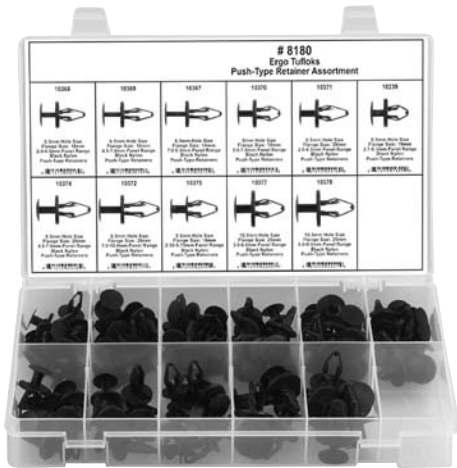

# 8180 Ergo Tufloks Push-Type Retainer Assortment					
10368 6.5mm Hole Size Flange Size: 18mm 2.0-4.5mm Panel Range Black Nylon Push-Type Retainers	10369 6.5mm Hole Size Flange Size: 18mm 4.5-7.0mm Panel Range Black Nylon Push-Type Retainers	10367 6.5mm Hole Size Flange Size: 14mm 7.0-9.5mm Panel Range Black Nylon Push-Type Retainers	10370 8mm Hole Size Flange Size: 19mm 5.0-7.0mm Panel Range Black Nylon Push-Type Retainers	10371 8.5mm Hole Size Flange Size: 20mm 2.0-4.5mm Panel Range Black Nylon Push-Type Retainers	10239 8.5mm Hole Size Flange Size: 19mm 2.7-5.3mm Panel Range Black Nylon Push-Type Retainers
10374 8.5mm Hole Size Flange Size: 20mm 4.5-7.0mm Panel Range Black Nylon Push-Type Retainers	10372 8.5mm Hole Size Flange Size: 20mm 7.0-10.0mm Panel Range Black Nylon Push-Type Retainers	10375 9.5mm Hole Size Flange Size: 18mm 2.0-5.5mm Panel Range Black Nylon Push-Type Retainers	10377 10.5mm Hole Size Flange Size: 25mm 3.0-6.0mm Panel Range Black Nylon Push-Type Retainers	10378 10.5mm Hole Size Flange Size: 25mm 6.0-9.0mm Panel Range Black Nylon Push-Type Retainers	

8180 (Plastic Tray)
 Shipped In a 12 Hole Plastic Tray
 6.5mm to 10mm Hole Size
 Black Nylon
 Contains 11 Different Sizes
 110 Total Pcs.
 Ergo Tufloks Retainer Assortment
 Sold Each



# 8181 Low Profile Mini Blade Fuse Assortment					
# 10829 5 Amp Tan Blade Type Low Profile Type ATM Mini Fuses	# 10831 10 Amp Red Blade Type Low Profile Type ATM Mini Fuses	# 10832 15 Amp Blue Blade Type Low Profile Type ATM Mini Fuses	# 10833 20 Amp Yellow Blade Type Low Profile Type ATM Mini Fuses	# 10834 25 Amp Natural Blade Type Low Profile Type ATM Mini Fuses	# 10835 30 Amp Green Blade Type Low Profile Type ATM Mini Fuses

8181 (Plastic Tray)
 Shipped In a 6 Hole Plastic Tray
 5 AMP - 30 AMP ATM Fuses
 Low Profile Type
 Contains 7 Different Sizes
 95 Total Pcs.
 Low Profile Fuse Assortment
 Sold Each

*Color Sales Brochures Available. Call for Details.





# 8182 Cowl Fastener Retainer Assortment					
<p># 10411</p> <p>6mm Hole Size Head Diameter: 14mm Stem Length: 11mm Black Nylon Retaining Clip</p>	<p># 9528</p> <p>5mm Hole Size Head Diameter: 11mm Stem Length: 17.8mm Black Nylon Rear Bumper Fascia Retainers</p>	<p># 5610</p> <p>7/32" (5.5mm) Hole Size Panel Range: .065" - .565" Universal Use Black Nylon Shield Retainers</p>	<p># 9446</p> <p>15/64" Hole Size Head Diameter: 3/4" Stem Length: 15/16" Black Nylon Shield Retainers</p>	<p># 5625</p> <p>1/4" (6.4mm) Hole Size Panel Range: .095" - .540" Universal Use Black Nylon Shield Retainers</p>	<p># 10517</p> <p>7.5mm Hole Size Head Diameter: 18mm Stem Length: 32mm Black Nylon Cowl Vent Retainers</p>
<p># 2077</p> <p>1 1/4-2 1/2" by 1 1/4" Hole Size 9/16" Flange Size 1" Over All Length Black Nylon Cowl Screen Ret. (Use with # 2076)</p>	<p># 2076</p> <p>13/16" Head Diameter Black Nylon Cowl Top Stud Retainer Cover (Use with # 2077)</p>	<p># 9114</p> <p>7mm Hole Size Head Diameter: 18mm Stem Length: 16mm Black Nylon Push-Type Retainers</p>	<p># 9968</p> <p>1/4" Hole Size Stem Length: 29/32" Flange Size: 5/8" Black Nylon Exterior Blind Rivets</p>	<p># 10621</p> <p>4mm stem diameter Top Hd: 13mm Bottom Hd: 16mm Stem length: 13mm White Nylon</p>	<p># 10691</p> <p>42mm From Tip to Tip Front To Back: 12mm Height: 21mm Roof & Gannish Moulding Clips</p>

8182 (Plastic Tray)
Shipped In a 12 Hole Plastic Tray
Cowl Retainers
All Nylon
Contains 12 Different Sizes
168 Total Pcs.
Cowl Retainer Assortment
Sold Each

*Color Sales Brochures Available. Call for Details.



# 8183 Double End & Spot Weld Drill Bit Assortment					
<p># 10843</p> <p>1/8" (.125) Drill Size 135° Split Point High Speed Steel Double End Drill Bits</p>	<p># 10844</p> <p>3/16" (.1875) Drill Size 135° Split Point High Speed Steel Double End Drill Bits</p>	<p># 10845</p> <p>1/4" (.250) Drill Size 135° Split Point High Speed Steel Double End Drill Bits</p>	<p># 10880</p> <p>6mm Drill Size For 1/4" Spot Welds Cobalt Spur Point Gold Finish High Speed Steel Spot Weld Drill Bits</p>	<p># 10881</p> <p>8mm Drill Size For 5/16" Spot Welds Cobalt Spur Point Gold Finish High Speed Steel Spot Weld Drill Bits</p>	<p># 10882</p> <p>10mm Drill Size For 3/8" Spot Welds Cobalt Spur Point Gold Finish High Speed Steel Spot Weld Drill Bits</p>

8183 (Plastic Tray)
Shipped In a 6 Hole Plastic Tray
Covers 1/8, 3/16 & 1/4 Double End Bits &
6mm, 8mm & 10mm Spot Weld Bits
Contains 6 Different Sizes
29 Total Pcs.
Drill Bit Assortment
Sold Each

*Color Sales Brochures Available. Call for Details.

12

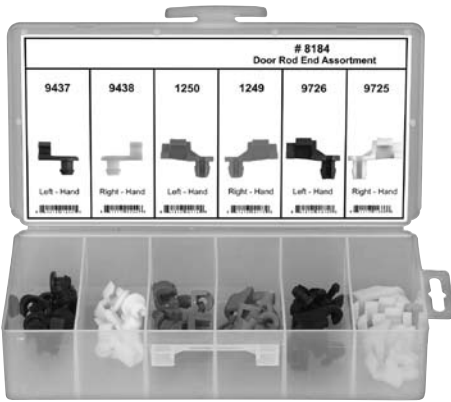

# 8184 Door Rod End Assortment					
9437	9438	1250	1249	9726	9725
Left - Hand	Right - Hand	Left - Hand	Right - Hand	Left - Hand	Right - Hand

8184 (Plastic Tray)
 Shipped In a 6 Hole Plastic Tray
 Covers G.M., Ford, Chrysler
 All Nylon
 Contains 6 Different Sizes
 33 Total Pcs.
 Universal Rod End Assortment
 Sold Each

*Color Sales Brochures Available. Call for Details.



# 8185 Zinc Finish Cotter Pin Assortment					
4063	4070	4088	4090	4096	4105
1/16 x 1" Zinc Finish Hammerlock Type Cotter Pins	3/32 x 1" Zinc Finish Hammerlock Type Cotter Pins	1/8 x 1 1/2" Zinc Finish Hammerlock Type Cotter Pins	1/8 x 2" Zinc Finish Hammerlock Type Cotter Pins	5/32 x 1 1/2" Zinc Finish Hammerlock Type Cotter Pins	3/16 x 1 1/2" Zinc Finish Hammerlock Type Cotter Pins

8185 (Plastic Tray)
 Shipped In a 6 Hole Plastic Tray
 Hammerlock Type
 Bright Zinc Finish
 Contains 6 Different Sizes
 150 Total Pcs.
 Cotter Pin Assortment
 Sold Each

*Color Sales Brochures Available. Call for Details.



BACK OF TRAY					
8501					
Universal Nylon Shield Retainer Assortment					
JL-24 1 7/64" (2.5mm) Hole Size Black Universal Nylon Shield Retainers	5602 2 5/32" (4mm) Hole Size Black Universal Nylon Shield Retainers	5605 3 3/16" (4.5mm) Hole Size Black Universal Nylon Shield Retainers	JL-32 4 3/16" (4.5mm) Hole Size Black Universal Weatherstrip Retainers	8172 5 3/16" (4.5mm) Hole Size Black Universal Dash Panel Retainers	5628 6 1/4" (6.4mm) Hole Size Black Universal Nylon Shield Retainers
JL-23 7 13/64" (5.3mm) Hole Size Short Black Weatherstrip Retainers	5609 8 13/64" (5.3mm) Hole Size Long Black Weatherstrip Retainers	JL-26 9 13/64" (5.3mm) Hole Size Black Universal Nylon Shield Retainers	5610 10 7/32" (5.5mm) Hole Size Black Universal Nylon Shield Retainers	5614 11 7/32" (5.5mm) Hole Size Black Universal Nylon Shield Retainers	5995 12 5/16" (7.8mm) Hole Size Black Rear Hood Seal Retainers
5618 13 15/64" (6mm) Hole Size Black Universal Nylon Shield Retainers	5506 14 1/4" (6.4mm) Hole Size Black Bumper Filler Retainers	5429 15 1/4" (6.4mm) Hole Size Short Black Universal Nylon Shield Retainers	5625 16 1/4" (6.4mm) Hole Size Long Black Universal Nylon Shield Retainers	5632 17 1/4" (6.4mm) Hole Size Black Facia Panel Retainers	JL-120 8 9/32" (7.1mm) Hole Size Black Textured Head Panel Retainers
8862B 19 5/16" (7.8mm) Hole Size Black Universal Nylon Shield Retainers	5640 20 5/64" (7.8mm) Hole Size Black Universal Nylon Shield Retainers	JL-33 21 5/16" (7.8mm) Hole Size Black Trim Panel Retainers	5643 22 23/64" (8mm) Hole Size Black Trim Panel Retainers	5710 23 3/8" (9.5mm) Hole Size Black Radiator Panel Retainers	5648 24 25/64" (10mm) Hole Size Black Facia Bumper Retainers
FRONT OF TRAY					

8500 (Bag)

Shipped In a 8" x 10" Plastic Bag

8501 (Metal Tray)

Shipped In a 24 Hole Gray Metal Tray

8601 (Plastic Tray)

Shipped In a 24 Hole Gray Plastic Tray

Covers 2.5mm to 10mm Hole Sizes























Black Nylon

Contains 24 Different Sizes 336 Total Pcs.

Shield Retainer Assortment

Sold Each



BACK OF TRAY					
8603					
Body Bolts, Hex Nuts Extruded "U" Nuts Assortment					
 6 - 1.00 x 22 mm Black Phos. Dog Point Metric Body Bolts	 6 - 1.00 x 20 mm Black Phos. CA Point Metric Body Bolts	 6 - 1.00 x 25 mm Black Phos. CA Point Metric Body Bolts	 8 - 1.25 x 25 mm Black Phos. CA Point Metric Body Bolts	 8 - 1.25 x 30 mm Black Phos. CA Point Metric Body Bolts	 10 - 1.50 x 40 mm Black Phos. CA Point Metric Body Bolts
 6 - 1.00 x 28 mm Black Phos. Dog Point Metric Body Bolts	 6 - 1.00 x 20 mm Black Phos. Flange Head Metric Body Bolts	 6 - 1.00 mm Black Phos. Short Type Extruded "U" Nuts	 8 - 1.25 x 30 mm Black Phos. Flange Head Metric Body Bolts	 8 - 1.25 mm Black Phos. Short Type Extruded "U" Nuts	 10 - 1.50 mm Black Phos. Short Type Extruded "U" Nuts
	 6 - 1.00 x 20 mm Black Phos. CA Point Metric Body Bolts	 6 - 1.00 mm Black Phos. Long Type Extruded "U" Nuts	 6.3 - 1.81 x 20 mm Black Phos. Sheet Metal Screws	 8 - 1.25 mm Black Phos. Long Type Extruded "U" Nuts	 10 - 1.50 mm Black Phos. Hex Flange Nuts
 5 - .80 mm Black Phos. Hex Flange Nuts	 6 - 1.00 x 35 mm Black Phos. CA Point Metric Body Bolts	 6 - 1.00 mm Black Phos. L/Washer Metric Hex Nuts	 6.3 - 1.81 x 25 mm Black Phos. Sheet Metal Screws	 8 - 1.25 mm Black Phos. L/Washer Metric Hex Nuts	
FRONT OF TRAY					

8502 (Bag)

Shipped In a 8" x 10" Plastic Bag

8503 (Metal Tray)

Shipped In a 24 Hole Gray Metal Tray

8603 (Plastic Tray)

Shipped In a 24 Hole Gray Plastic Tray

Covers "U" & Hex Nuts & Body Bolts

Contains 22 Different Sizes

203 Total Pcs.

Body Bolt & Nut Assortment

Sold Each



BACK OF TRAY

8605					
Universal Trim Screw Assortment					
<p>6185 1</p> <p>8 x 1/2" Phil. Oval Washer Head Chrome Wheel Opening Midg. Tek® Screws</p>	<p>6401 2</p> <p>8 x 3/4" #6 Head Phil. Oval Head Chrome Sheet Metal Screws</p>	<p>1184 3</p> <p>8 x 3/4" #6 Head Phil. Oval Head Black Sheet Metal Screws</p>	<p>7004 4</p> <p>4.2 - 1.41 x 30 mm Oval Head Chrome Stainless Steel Torx® Trim Screws</p>	<p>5554 5</p> <p>4.2 - 1.41 x 20 mm Hex Head Loose Washer Black Tek® Screws</p>	<p>2970 6</p> <p>8 x 3/4" Phil. Flat Top Washer Head Black Black Trim Screws</p>
<p>6010 7</p> <p>8 x 1/2" Phil. Oval Washer Head Black Wheel Opening Midg. Tek® Screws</p>	<p>6402 8</p> <p>8 x 1" #6 Head Phil. Oval Head Chrome Sheet Metal Screws</p>	<p>1186 9</p> <p>8 x 1" #6 Head Phil. Oval Head Black Sheet Metal Screws</p>	<p>7005 10</p> <p>4.2 - 1.41 x 30 mm Oval Head Black Stainless Steel Torx® Trim Screws</p>	<p>5552 11</p> <p>4.2 - 1.41 x 20 mm Hex Head Loose Washer Black Tek® Screws</p>	<p>9145 12</p> <p>10 x 3/4" Phil. Flat Top Washer Head Black Trim Screws</p>
<p>6265 13</p> <p>8 x 3/4" Phil. Oval Washer Head Black Tek® Screws</p>	<p>6403 14</p> <p>8 x 1 1/4" #6 Head Phil. Oval Head Chrome Sheet Metal Screws</p>	<p>1624 15</p> <p>8 x 3/4" Phil. Pan Head Black Sheet Metal Screws</p>	<p>7006 16</p> <p>4.2 - 1.41 x 25 mm Pan Head Chrome Stainless Steel Torx® Trim Screws</p>	<p>5791 17</p> <p>8 x 1/2" Phil. Flat Top Washer Head Black Trim Screws</p>	18
<p>1077 19</p> <p>8 x 1/2" Indented Hex Washer Head Zinc Tek® Screws</p>	<p>6411 20</p> <p>10 x 1" #8 Head Phil. Oval Head Chrome Sheet Metal Screws</p>	<p>1625 21</p> <p>8 x 1" Phil. Pan Head Black Sheet Metal Screws</p>	<p>7007 22</p> <p>4.2 - 1.41 x 25 mm Pan Head Black Stainless Steel Torx® Trim Screws</p>	<p>5984 23</p> <p>8 x 3/4" Phil. Flat Top Washer Head Black Trim Screws</p>	<p>1620 24</p> <p>14 x 3/4" Ind. Hex Washer Head Slotted Zinc License Plate Screws</p>

FRONT OF TRAY

8504 (Bag)

Shipped In a 8" x 10" Plastic Bag

8505 (Metal Tray)

Shipped In a 24 Hole Gray Metal Tray

8605 (Plastic Tray)

Shipped In a 24 Hole Gray Plastic Tray

Covers Phillips, Hex & Torx Drive
 Chrome & Black Finishes
 Contains 23 Different Sizes
 550 Total Pcs.
 Trim Screw Assortment
 Sold Each

12



























BACK OF TRAY											
8607											
Universal Rivet Assortment											
1889	1	1901	2	1904	3	4005	4	1609	5	1951	6
1/8" Hole Size Grip Range: 3/16" - 1/4" Grip Range: 3/16" - 1/4" All Alum. Pop Rivets		3/16" Hole Size Flange Size 3/8" Grip Range: 1/4" - 3/8" All Alum. Pop Rivets		3/16" Hole Size Flange Size 5/8" Grip Range: 1/4" - 3/8" All Alum. Pop Rivets		3/16" Hole Size Flange Size 9/16" Grip Range: 3/8" - 1/2" All Alum. Black Grille & Facia Rivets		3/16" Hole Size Flange Size 7/16" Grip Range: 5/64" - 1/8" Black Alum. W/House Midg. & Split-Type Rivets		1/4" Hole Size Flange Size 1 1/16" Grip Range: 3/16" - 3/8" Black Alum. Bumper Cover & Split-Type Rivets	
9118	7		8	4002	9	4009	10	4007	11	4008	12
1/8" Hole Size Flange Size 3/8" Grip Range: 3/16" - 1/4" Alum. Rivet Steel Mandrel Black Pop Rivets				1/4" Hole Size Flange Size 3/4" Grip Range: 1/8" - 1/4" All Steel Black Bumper Rivets		1/4" Hole Size Flange Size 1/2" Grip Range: 3/32" - 1/8" Alum. Rivet Steel Mandrel Blk Door Handle Rivets		1/4" Hole Size Flange Size 1/2" Grip Range: 1/32" - 9/64" Alum. Rivet Steel Mandrel Window Reg. Peel Rivets		1/4" Hole Size Flange Size 1/2" Grip Range: 3/32" - 1/8" Alum. Rivet Steel Mandrel Glass Stop Peel Rivets	
	13	5769	14	9053	15	1195	16		17		18
		3/16" (5mm) Hole Size Flange Size 15/32" GR: 1/8" - 15/64" Black Nylon Blind Rivets		13/64" (5mm) Hole Size Flange Size 19/32" GR: 1/16" - 1/16" Black Nylon Blind Rivets		3/16" (5mm) Hole Size Flange Size 15/32" GR: 15/64" - 25/64" Black Nylon Blind Rivets					
9054	19	1390	20	5775	21	5770	22	9128	23		24
1/4" (6.3mm) Hole Size Flange Size 1/2" GR: 3/32" - 3/16" Black Nylon Blind Rivets		1/4" (6.3mm) Hole Size Flange Size 1/2" GR: 3/32" - 1/32" Black Nylon Blind Rivets		17/64" (6.3mm) Hole Size Flange Size 45/64" GR: 3/32" - 3/16" Black Nylon Blind Rivets		1/4" (6.3mm) Hole Size Flange Size 43/64" GR: 3/32" - 1/32" Black Nylon Blind Rivets		1/4" (6.3mm) Hole Size Flange Size 43/64" GR: 5/16" - 19/32" Black Nylon Blind Rivets			
FRONT OF TRAY											

- # 8506 (Bag)
Shipped In a 8" x 10" Plastic Bag
- # 8507 (Metal Tray)
Shipped In a 24 Hole Gray Metal Tray
- # 8607 (Plastic Tray)
Shipped In a 24 Hole Gray Plastic Tray

Covers 1/8", 3/16" & 1/4" Hole Size
Nylon & Metal Rivets
Contains 19 Different Sizes
263 Total Pcs.
Automotive Rivet Assortment
Sold Each



BACK OF TRAY					
8609					
Universal Nylon Shield Retainer Assortment					
 <p>5602 1 5/32" (4mm) Hole Size Black Universal Nylon Shield Retainers</p>	 <p>5605 2 3/16" (4.5mm) Hole Size Black Universal Nylon Shield Retainers</p>	 <p>JL-32 3 3/16" (4.5mm) Hole Size Black Universal Weatherstrip Retainers</p>	 <p>8172 4 3/16" (4.5mm) Hole Size Black Universal Dash Panel Retainers</p>	 <p>1583 5 3/16" (5mm) Hole Size Black Universal Nylon Shield Retainers</p>	 <p>5627 6 Black Universal Nylon Trim Panel Retainers</p>
 <p>JL-23 7 13/64" (5.3mm) Hole Size Short Black Weatherstrip Retainers</p>	 <p>5609 8 13/64" (5.3mm) Hole Size Long Black Weatherstrip Retainers</p>	 <p>5614 9 7/32" (5.5mm) Hole Size Black Universal Nylon Shield Retainers</p>	 <p>5506 10 1/4" (6.4mm) Hole Size Black Bumper Filler Retainers</p>	 <p>5429 11 1/4" (6.4mm) Hole Size Short Black Universal Nylon Shield Retainers</p>	 <p>5995 12 5/16" (7.8mm) Hole Size Black Rear Hood Seal Retainers</p>
 <p>5625 13 1/4" (6.4mm) Hole Size Long Black Universal Nylon Shield Retainers</p>	 <p>9130 14 1/4" (6.4mm) Hole Size Extra Long Black Universal Nylon Shield Retainers</p>	 <p>5632 15 1/4" (6.4mm) Hole Size Black Fascia Panel Retainers</p>	 <p>5628 16 1/4" (6.4mm) Hole Size Black Universal Nylon Shield Retainers</p>	 <p>9132 17 9/32" (7.1mm) Hole Size Black Universal Nylon Shield Retainers</p>	 <p>JL-120 18 9/32" (7.1mm) Hole Size Black Textured Heat Panel Retainers</p>
 <p>5640 19 5/64" (7.8mm) Hole Size Black Universal Nylon Shield Retainers</p>	 <p>JL-33 20 5/16" (7.8mm) Hole Size Black Trim Panel Retainers</p>	 <p>5643 21 23/64" (8mm) Hole Size Black Trim Panel Retainers</p>	 <p>5710 22 3/8" (9.5mm) Hole Size Black Radiator Panel Retainers</p>	 <p>5648 23 25/64" (10mm) Hole Size Black Fascia Bumper Retainers</p>	 <p>5648 24 25/64" (10mm) Hole Size Black Fascia Bumper Retainers</p>
FRONT OF TRAY					

8508 (Bag)

Shipped In a 8" x 10" Plastic Bag

8509 (Metal Tray)

Shipped In a 24 Hole Gray Metal Tray

8609 (Plastic Tray)

Shipped In a 24 Hole Gray Plastic Tray

Covers 5/32" to 25/64" Hole Sizes

Black Nylon

Contains 23 different sizes

311 Total Pcs.

Shield Retainer Assortment

Sold Each



BACK OF TRAY					
8611					
Universal Nut and Shim Assortment					
 1621 1 6 - 1.00mm Screw Size 17mm Flange O.D. Push On Type Retainers	 3010 2 8 - 1.25mm Screw Size 24mm O.D. Push On Bumper Strip Retainers	 1276 3 10 - 1.50mm Screw Size 24mm O.D. Push On Retainers	 1350 4 8 Screw Size Panel Range: .020\" Center of Hole to Edge: .310\" Wide Range "U" Nuts	 5750 5 8 Screw Size Panel Range: .020\" Center of Hole to Edge: .508\" Wide Range "U" Nuts	 6015 6 1/16\" Thick 3/8\" Slot 1 1/4\" x 1 1/8\" Bright Zinc Finish Steel Body Shims
 263 8 3/16\" (5mm) Stud Size 3/8\" Hex Size 5/8\" Flange General Purpose Thread Cutting Nuts	 9226 9 1/4\" (6.3mm) Stud Size 7/16\" Hex Size 1 1/16\" Flange General Purpose Thread Cutting Nuts	 856 10 5/16\" (8mm) Stud Size 1/2\" Hex Size 7/8\" Flange General Purpose Thread Cutting Nuts			 6016 12 1/8\" Thick 3/8\" Slot 1 1/4\" x 1 1/8\" Bright Zinc Finish Steel Body Shims
 1577 13 8 Screw Size Universal Use Natural Nylon Grille Screw Nuts	 1842 14 8 or 10 Screw Size Universal Use Natural Nylon Grille Screw Nuts	 2980 15 8 or 10 Screw Size Universal Use Natural Nylon Grille Screw Nuts	 2940 16 8 or 10 Screw Size Universal Use Natural Nylon Headlamp Bezel Nuts	 9050 17 8 or 10 Screw Size Universal Use Natural Nylon Grille Screw Nuts	 6018 18 1/8\" Thick 3/4\" Slot 2\" x 1 1/2\" Steel Shims
 9111 19 8 Screw Size Universal Use Natural Nylon Headlamp Bezel Nuts	 1560 20 10 Screw Size Natural Nylon Headlamp Bezel & Grille Nuts	 1572 21 8 Screw Size Universal Use Natural Nylon Screw Grommet Nuts	 1228 22 1/4\" (#14) Screw Size Universal Use White Plastic Scene Plate Nuts		
FRONT OF TRAY					

8510 (Bag)

Shipped In a 8" x 10" Plastic Bag

8511 (Metal Tray)

Shipped In a 24 Hole Gray Metal Tray

8611 (Plastic Tray)

Shipped In a 24 Hole Gray Plastic Tray

Covers Grille & Push On Nuts & BodyShims

Contains 20 Different Sizes

450 Total Pcs.

Nut & Body Shim Assortment

Sold Each



BACK OF TRAY					
8613					
Universal Push Type Retainer Assortment					
5675	5935	5676	1861	1860	5677
1 1/2" (4mm) Hole Size Panel Range: 3/16" - 3/8" Black Nylon Mud Flap Blind Rivets 【黒ナイロンボルト付】	1 1/2" (4mm) Hole Size Panel Range: 7/16" - 1/2" Black Nylon Splash Shield Blind Rivets 【黒ナイロンボルト付】	5/16" (7.5mm) Hole Size 2" Black Nylon Radiators/Windshield Outer Retainers 【黒ナイロンボルト付】	5/16" (8mm) Hole Size Flange 15mm Stem Length: 20mm Push Type Retainers 【黒ナイロンボルト付】	5/16" (8mm) Hole Size Flange: 20mm Stem Length: 20mm Push Type Retainers 【黒ナイロンボルト付】	3/8" (9.5mm) Hole Size Panel Range: 1/2" - 3/4" Black Nylon Face a Retainers 【黒ナイロンボルト付】
5940	2128	9282	9294	9382	5672
7 5/16" (8mm) Hole Size Panel Range: 3/16" - 3/8" Black Nylon Square Tip Blind Rivets 【黒ナイロンボルト付】	6 5/16" (8mm) Hole Size Flange: 20mm Stem Length: 17mm Push Type Retainers 【黒ナイロンボルト付】	9 5/16" (8mm) Hole Size Hood: 20mm Stem: 12mm Front Bumper Push Type Retainers 【黒ナイロンボルト付】	25/64" (15mm) Hole Size Flange: 18mm Stem Length: 15mm Push Type Retainers 【黒ナイロンボルト付】	1/2" (12.5mm) Hole Size Hood: 20mm Stem: 12mm Front & Rear Bumper Push Type Retainers 【黒ナイロンボルト付】	1 1/2" (12.7mm) Hole Size Panel Range: 1/2" - 3/4" Black Nylon Dumper Push Blind Rivets Retainers 【黒ナイロンボルト付】
5930	9067	1603	5920	1976	D-123
1 1/4" (8mm) Hole Size Flange: 18mm Stem Length: 18mm Vent Panel Blind Rivets 【黒ナイロンボルト付】	1 1/4" (8mm) Hole Size Flange: 17.5mm Stem Length: 23mm Radiators Ground Blind Rivets 【黒ナイロンボルト付】	3/32" (7mm) Hole Size Flange: 15mm Stem Length: 12mm Push Type Retainers 【黒ナイロンボルト付】	5/16" (8mm) Hole Size Flange: 20mm Stem Length: 8mm Splash Shield Blind Rivets 【黒ナイロンボルト付】	5/16" (8mm) Hole Size Flange: 20mm Stem Length: 9mm Splash Shield Blind Rivets 【黒ナイロンボルト付】	3/8" (9.5mm) Hole Size Flange: 20mm Stem Length: 27mm Dumper Face a Retainers 【黒ナイロンボルト付】
5901	1973	5895	9202		D-124
19 5/16" (8mm) Hole Size Flange: 20mm Stem Length: 18mm Inner Fender Blind Rivets 【黒ナイロンボルト付】	5/16" (8mm) Hole Size Flange: 17.5mm Stem Length: 27mm Push Type Retainers 【黒ナイロンボルト付】	23/64" (9mm) Hole Size Flange: 15mm Stem Length: 17mm Gumpen Cover Blind Rivets 【黒ナイロンボルト付】	25/64" (15mm) Hole Size Flange: 20mm Stem Length: 15mm Push Type Retainers 【黒ナイロンボルト付】		3/8" (9.5mm) Hole Size Flange: 20mm Stem Length: 24mm Dumper Face a Retainers 【黒ナイロンボルト付】
FRONT OF TRAY					

8512 (Bag)

Shipped In a 8" x 10" Plastic Bag

8513 (Metal Tray)

Shipped In a 24 Hole Gray Metal Tray

8613 (Plastic Tray)

Shipped In a 24 Hole Gray Plastic Tray

Covers 6mm to 10mm Hole Size

Black Nylon

Contains 23 Different Sizes





















204 Total Pcs.

Retainer Assortment

Sold Each



BACK OF TRAY

8615 Universal Weatherstrip Retainer Hood Insulation and Door Panel Clip Assortment					
 9242 1 White Nylon Door Trim Panel Clips	 5264 2 Natural Nylon Door Trim Panel Clips	 1646 3 Natural Nylon Door Trim Panel Clips	 4020 4 Natural Nylon Door Trim Panel Clips	 2029 5 White Nylon Push-Type Door Trim Panel Clips	 1930 6 1/4" (6.4mm) Hole Size 1.2132" O.D. Head Size Black Nylon Hood Insulation Clips
 1575 7 Black Nylon Door Trim Panel Clips	 1742 8 Natural Nylon Door Trim Panel Clips	 2108 9 White Nylon Door Trim Panel Clips			 5440 12 1/4" (6.4mm) Hole Size 2" O.D. Head Size Black Polypropylene Hood Insulation Clips
 2063 13 6.7mm Hole Size Top Head Dia: 13mm Stem Length: 15mm White Nylon Door Panel Retainers	 9444 14 8mm Hole Size Top Head Dia: 13mm Stem Length: 15mm White Nylon Door Panel Retainers	 9081 15 9mm Hole Size Top Head Dia: 13mm Stem Length: 14mm White Nylon Door Panel Retainers	 1996 16 5mm Hole Size Head Dia: 13mm Stem Length: 15mm Black Nylon Retaining Clips	 1950 17 7mm Hole Size Head Dia: 30mm Stem Length: 17mm Black Nylon Retaining Clips	 5440 18 1/4" (6.4mm) Hole Size 2" O.D. Head Size Black Polypropylene Hood Insulation Clips
 1991 19 4.5mm Hole Size Black Nylon Weatherstrip Retainers	 9264 20 4.5mm Hole Size Black Nylon Weatherstrip Retainers	 9208 21 6mm Hole Size Orange Nylon Weatherstrip Retainers	 5606 22 6mm Hole Size Head Dia: 10mm Stem Length: 10mm Black Nylon Hood Insulation Retainers	 9262 23 6mm Hole Size Head Dia: 12mm Stem Length: 3mm Black Nylon Hood Insulation Retainers	

FRONT OF TRAY

8514 (Bag)

Shipped In a 8" x 10" Plastic Bag

8515 (Metal Tray)

Shipped In a 24 Hole Gray Metal Tray

8615 (Plastic Tray)

Shipped In a 24 Hole Gray Plastic Tray

Covers G.M., Ford & Chrysler

All Nylon

Contains 21 Different Sizes

197 Total Pcs.

Door Panel, W/Strip & Hood Ins Asst

























Sold Each



BACK OF TRAY

8617

**Standard Hex Nut, Lockwasher
Flatwasher & Hex Head Cap Screw
Assortment**

 <p>1313 1 1/4" - 20 (USS) 7/16" Wrench Size Zinc Finish Hex Nuts</p>	 <p>1314 2 5/16" - 18 (USS) 1/2" Wrench Size Zinc Finish Hex Nuts</p>	 <p>1315 3 3/8" - 16 (USS) 9/16" Wrench Size Zinc Finish Hex Nuts</p>	 <p>1316 4 7/16" - 14 (USS) 11/16" Wrench Size Zinc Finish Hex Nuts</p>	 <p>1317 5 1/2" - 13 (USS) 3/4" Wrench Size Zinc Finish Hex Nuts</p>	 <p>1353 6 1/2" - 13 x 2" (USS) Grade 5 Zinc Finish Hex Head Cap Screws</p>
 <p>1325 7 1/4" - Bright Zinc Finish Standard Lockwashers</p>	 <p>1326 8 5/16" - Bright Zinc Finish Standard Lockwashers</p>	 <p>1327 9 3/8" - Bright Zinc Finish Standard Lockwashers</p>	 <p>1328 10 7/16" - Bright Zinc Finish Standard Lockwashers</p>	 <p>1329 11 1/2" - Bright Zinc Finish Standard Lockwashers</p>	 <p>9749 12 7/16" - 14 x 1 1/2" (USS) Grade 5 Zinc Finish Hex Head Cap Screws</p>
 <p>1364 13 1/4" (SAE) Bright Zinc Finish Flatwashers</p>	 <p>1365 14 5/16" (SAE) Bright Zinc Finish Flatwashers</p>	 <p>1366 15 3/8" (SAE) Bright Zinc Finish Flatwashers</p>	 <p>1367 16 7/16" (SAE) Bright Zinc Finish Flatwashers</p>	 <p>1368 17 1/2" (SAE) Bright Zinc Finish Flatwashers</p>	 <p>1345 18 3/8" - 16 x 2" (USS) Grade 5 Zinc Finish Hex Head Cap Screws</p>
 <p>1331 19 1/4" - 20 x 3/4" (USS) Grade 5 Zinc Finish Hex Head Cap Screws</p>	 <p>1332 20 1/4" - 20 x 1" (USS) Grade 5 Zinc Finish Hex Head Cap Screws</p>	 <p>1337 21 5/16" - 18 x 1" (USS) Grade 5 Zinc Finish Hex Head Cap Screws</p>	 <p>1339 22 5/16" - 18 x 1 1/2" (USS) Grade 5 Zinc Finish Hex Head Cap Screws</p>	 <p>1342 23 3/8" - 16 x 1" (USS) Grade 5 Zinc Finish Hex Head Cap Screws</p>	 <p>1344 24 3/8" - 16 x 1 1/2" (USS) Grade 5 Zinc Finish Hex Head Cap Screws</p>

FRONT OF TRAY

8516 (Bag)

Shipped In a 8" x 10" Plastic Bag

8517 (Metal Tray)

Shipped In a 24 Hole Gray Metal Tray

8617 (Plastic Tray)

Shipped In a 24 Hole Gray Plastic Tray

Covers 1/4 to 1/2" Nuts, Flats, Locks &

Grade 5 Cap Screws

Contains 24 Different Sizes

612 Total Pcs.

Nut, Washer & Hex Cap Screw Assortment

Sold Each

12



BACK OF TRAY

8619

**Metric Hex Nut, Lockwasher
Flatwasher & Hex Head Cap Screw
Assortment**

862 1	863 2	865 3	866 4	867 5	905 6
1659 7	1661 8	1662 9	1663 10	1664 11	904 12
1652 13	1654 14	1655 15	1656 16	1657 17	899 18
874 19	877 20	880 21	888 22	890 23	895 24

FRONT OF TRAY

8518 (Bag)

Shipped In a 8" x 10" Plastic Bag

8519 (Metal Tray)

Shipped In a 24 Hole Gray Metal Tray

8619 (Plastic Tray)

Shipped In a 24 Hole Gray Plastic Tray

Covers 5mm to 12mm Nuts, Flats, Locks
Hex Cap Screws
Contains 24 Different Sizes
698 Total Pcs.
Metric Cap Screw Assortment
Sold Each



BACK OF TRAY

8620 G.M. Rocker Panel Moulding Assortment

Photos Not Actual Size

<p># 10826 1</p> <p>9mm Hole Size Stem Lgh: 15mm Top Hd Size: 12mm x 20mm Bottom Head Size: 12mm x 24mm Black Nylon Rocker Panel Moulding Clips • 適用於車身零件安裝</p>	<p># 10485 2</p> <p>9mm Hole Size Stem Length: 14mm Top Head Size: 14mm x 20mm Yellow Nylon w/Sealer Rocker Panel Moulding Clips • 適用於車身零件安裝</p>	<p># 10357 3</p> <p>9mm Hole Size Stem Length: 14mm Top Head: 12mm x 20mm White Nylon Rocker Panel Moulding Clips • 適用於車身零件安裝</p>	<p># 10481 4</p> <p>9mm Hole Size Stem Length: 15mm Top Head: 12mm x 20mm Gray Nylon w/Sealer Windshield Piler Mdg. Clips • 適用於車身零件安裝</p>	<p># 10480 5</p> <p>9mm Hole Size Stem Length: 11mm Top Head: 12mm x 20mm White Nylon Body Side Moulding Clips • 適用於車身零件安裝</p>	<p># 10651 6</p> <p>17mm Hole Size Top Head: 20mm x 20mm Overall Length: 28mm Black Nylon Rocker Panel Moulding Clips • 適用於車身零件安裝</p>
<p># 10680 7</p>	<p># 10827 8</p> <p>10mm Hole Size Stem Lgh: 15mm Top Hd Size: 10mm x 20mm Bottom Head Size: 12mm x 32mm White Nylon Rocker Moulding Clips • 適用於車身零件安裝</p>	<p># 9992 9</p>	<p># 9991 10</p>	<p># 9990 11</p>	<p># 10059 12</p>
<p># 10056 13</p>	<p># 10429 14</p>	<p># 9914 15</p>	<p># 9915 16</p>	<p># 10823 17</p> <p>7mm Hole Size Stem Length: 13mm Top Head Size: 13mm x 30mm Gray Nylon Roof Rail Mdg. Clip w/Sealer • 適用於車身零件安裝</p>	<p># 10058 18</p>
<p># 9969 19</p>	<p># 10488 20</p>	<p># 10489 21</p>	<p># 9967 22</p>	<p># 10482 23</p> <p>10mm Hole Size Stem Length: 10mm Head Size: 18mm x 38mm Green Nylon Body Side Moulding Clips • 適用於車身零件安裝</p>	<p># 10128 24</p>

FRONT OF TRAY

8520 (Metal Tray)
Shipped In a 24 Hole Gray Metal Tray

8620 (Plastic Tray)
Shipped In a 24 Hole Gray Plastic Tray

Covers G.M. Cars & Trucks
All Nylon
Contains 24 Different Sizes
220 Total Pcs.
G.M. Rocker Panel Moulding Assortment
Sold Each

*Color Sales Brochures Available. Call for Details.

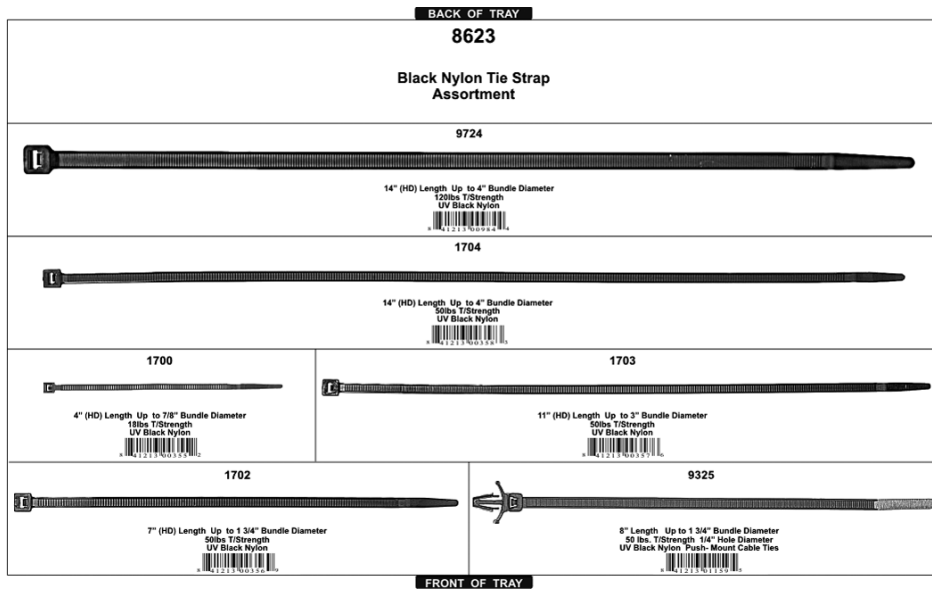

8623 (Plastic Tray)
Shipped In an Adjustable Gray Plastic Tray

Covers 4", 7", 8", 11", 14" and 14" HD
Black Nylon Ties
Contains 6 Different Sizes
310 Total Pcs.
Black Nylon Tie Strap Assortment
Sold Each



BACK OF TRAY

8625 Universal Domestic Door Rod & Hood Prop Clips Assortment															
1	9728 5/32" Rod Size Left Hand Side Nylon Nylon Door Lock Rod Clips Ford F 350-390 A 121316112	2	9981 3/8" Rod Size Green Nylon Door & Trunk Rod Clips 121316113	3	10076 5/16" Rod Size Nylon Hood Prop Clips Ford F 350-390 C 121316114	4	10079 1/8" Rod Size Black Nylon Hood Prop Clips Ford F 350-390 C 121316115	5	10080 Fold Over Type Nylon Door Lock Rod Clips Ford F 350-390 DD 121316116	6	10081 5/16" Rod Size Nylon Nylon Hood Prop Clips Ford F 350-390 E 121316117	7	10077 Even Rod Diameter Fit Trunk Trunk Rod Nylon Nylon Hood Prop Clips Ford F 350-390 E 121316118	8	
9	10078 Fold Over Type Nylon Door Lock Rod Clips Ford F 350-390 SA 121316119	10	9725 5/32" Rod Size Nylon Nylon Door Lock Rod Clips 121316120	11	9729 5/32" Rod Size Right Hand Side Nylon Nylon Door Lock Rod Clips 121316121	12	9726 5/32" Rod Size Left Hand Side Black Nylon Door Lock Rod Clips 121316122	13	9384 1/8" Rod Size Left Hand Side Orange Nylon Door Lock Rod Clips 121316123	14	9987 5/32" Rod Size Left Hand Side Black Nylon Door Lock Rod Clips 121316124	15	10082 5/16" Rod Size Nylon Hood Prop Clips 121316125	16	
17	9438 5/32" Rod Size Right Hand Side Nylon Nylon Door Lock Rod Clips 121316126	18	1083 Door Lock Rod Clips 121316127	19	10083 For Clipping Hole Left & Right Hand Side Black Nylon Door Lock Rod Clips 121316128	20	9986 5/32" Rod Size Right Hand Side Nylon Nylon Door Lock Rod Clips 121316129	21	10084 Tree Rod Size Nylon Hood Prop Clips 121316130	22	9437 5/32" Rod Size Left Hand Side Black Nylon Door Lock Rod Clips 121316131	23	9731 5/32" Rod Size Even Rod Size Orange Nylon Door Lock Rod Clips 121316132	24	
25	9988 5/16" Rod Size 1 3/8" O.A. Length Black Nylon Hood Prop Clips 121316133	26	1250 5/32" Rod Size Left Hand Side Green Nylon Door Lock Rod Clips 121316134	27	9960 5/32" Rod Size Left Hand Side Black Nylon Door Lock Rod Clips 121316135	28	9963 5/32" Rod Size Left Hand Side Green Nylon Door Lock Rod Clips 121316136	29	9961 1/8" Rod Size Right Hand Side Purple Nylon Door Lock Rod Clips 121316137	30	1249 5/32" Rod Size Right Hand Side Red Nylon Door Lock Rod Clips 121316138	31	9959 5/32" Rod Size Right Hand Side Black Nylon Door Lock Rod Clips 121316139	32	9962 5/32" Rod Size Right Hand Side Red Nylon Door Lock Rod Clips 121316140

FRONT OF TRAY

8625 (Plastic Tray)
Shipped In an Adjustable Gray Plastic Tray

8625YC (Plastic Tray)
Shipped In an Adjustable Yellow Plastic Tray

Covers G.M., Ford, Chrysler
All Nylon
Contains 29 Different Sizes
310 Total Pcs.
Door Rod and Hood Prop Assortment
Sold Each

12



BACK OF TRAY

8627 Tray 2

Universal Miniature Light Bulb Assortment

1	2	3	4
5	6	7	8
9	10	11	12
13	14	15	

FRONT OF TRAY

BACK OF TRAY

8627 Tray 1

Universal Miniature Light Bulb Assortment

1	2	3	4	5	6	7	8
9	10	11	12	13	14	15	16
17	18	19	20	21		23	24
25	26	27	28				

























FRONT OF TRAY

8627 (Plastic Tray)
 Shipped In 2 Adjustable Gray Plastic Trays
8627YC (Plastic Tray)
 Shipped In 2 Adjustable Yellow Plastic Trays

Covers Wedge & Round Base
 Clear & Amber Miniature Bulbs
 Contains 42 Different Sizes
 420 Total Pcs.
 Miniature Bulb Assortment
 Sold Each

12



BACK OF TRAY					
8629 Bright Zinc Finish 10.9 J.I.S. Small Head Metric Hex Flange Bolt Assortment					
<p>3200 1</p>  <p>6 - 1.00mm Class 10 10mm Hex 14mm Serrated Flange Bright Zinc Finish Metric Split Lock Nuts JIS B1190</p>	<p>3201 9981</p>  <p>8 - 1.25mm Class 10 12mm Hex 17mm Serrated Flange Bright Zinc Finish Metric Split Lock Nuts JIS B1190</p>	<p>3202 3</p>  <p>10 - 1.25mm Class 10 14mm Hex 19mm Serrated Flange Bright Zinc Finish Metric Split Lock Nuts JIS B1190</p>	<p>3203 4</p>  <p>6 - 1.00 x 12mm Class 10.9 10mm Hex 14mm Flange Bright Zinc Finish Metric Flange Bolts JIS B1189</p>	<p>3204 5</p>  <p>6 - 1.00 x 16mm Class 10.9 10mm Hex 14mm Flange Bright Zinc Finish Metric Flange Bolts JIS B1189</p>	<p>3219 6</p>  <p>10 - 1.25 x 25mm Class 10.9 14mm Hex 21mm Flange Bright Zinc Finish Metric Flange Bolts JIS B1189</p>
<p>3205 7</p>  <p>6 - 1.00 x 20mm Class 10.9 10mm Hex 14mm Flange Bright Zinc Finish Metric Flange Bolts JIS B1189</p>	<p>3206 8</p>  <p>6 - 1.00 x 25mm Class 10.9 10mm Hex 14mm Flange Bright Zinc Finish Metric Flange Bolts JIS B1189</p>	<p>3207 9</p>  <p>6 - 1.00 x 30mm Class 10.9 10mm Hex 14mm Flange Bright Zinc Finish Metric Flange Bolts JIS B1189</p>	<p>3208 10</p>  <p>6 - 1.00 x 35mm Class 10.9 10mm Hex 14mm Flange Bright Zinc Finish Metric Flange Bolts JIS B1189</p>	<p>3209 11</p>  <p>6 - 1.00 x 40mm Class 10.9 10mm Hex 14mm Flange Bright Zinc Finish Metric Flange Bolts JIS B1189</p>	<p>3220 12</p>  <p>10 - 1.25 x 30mm Class 10.9 14mm Hex 21mm Flange Bright Zinc Finish Metric Flange Bolts JIS B1189</p>
<p>9824 13</p>  <p>6 - 1.00 x 45mm Class 10.9 10mm Hex 14mm Flange Bright Zinc Finish Metric Flange Bolts JIS B1189</p>	<p>3210 14</p>  <p>8 - 1.25 x 12mm Class 10.9 12mm Hex 17.5mm Flange Bright Zinc Finish Metric Flange Bolts JIS B1189</p>	<p>3211 15</p>  <p>8 - 1.25 x 16mm Class 10.9 12mm Hex 17.5mm Flange Bright Zinc Finish Metric Flange Bolts JIS B1189</p>	<p>3212 16</p>  <p>8 - 1.25 x 20mm Class 10.9 12mm Hex 17.5mm Flange Bright Zinc Finish Metric Flange Bolts JIS B1189</p>	<p>3213 17</p>  <p>8 - 1.25 x 25mm Class 10.9 12mm Hex 17.5mm Flange Bright Zinc Finish Metric Flange Bolts JIS B1189</p>	<p>3221 18</p>  <p>10 - 1.25 x 35mm Class 10.9 14mm Hex 21mm Flange Bright Zinc Finish Metric Flange Bolts JIS B1189</p>
<p>3214 19</p>  <p>8 - 1.25 x 30mm Class 10.9 12mm Hex 17.5mm Flange Bright Zinc Finish Metric Flange Bolts JIS B1189</p>	<p>3215 20</p>  <p>8 - 1.25 x 35mm Class 10.9 12mm Hex 17.5mm Flange Bright Zinc Finish Metric Flange Bolts JIS B1189</p>	<p>3216 21</p>  <p>8 - 1.25 x 40mm Class 10.9 12mm Hex 17.5mm Flange Bright Zinc Finish Metric Flange Bolts JIS B1189</p>	<p>3217 22</p>  <p>10 - 1.25 x 16mm Class 10.9 14mm Hex 21mm Flange Bright Zinc Finish Metric Flange Bolts JIS B1189</p>	<p>3218 23</p>  <p>10 - 1.25 x 20mm Class 10.9 14mm Hex 21mm Flange Bright Zinc Finish Metric Flange Bolts JIS B1189</p>	<p>3222 24</p>  <p>10 - 1.25 x 40mm Class 10.9 14mm Hex 21mm Flange Bright Zinc Finish Metric Flange Bolts JIS B1189</p>
FRONT OF TRAY					

12

8629 (Plastic Tray)

Shipped In a 24 Hole Gray Plastic Tray













Covers 6mm, 8mm, & 10mm Screw Sizes
 Class 10.9 Hex Flange Nuts & Bolts
 Contains 24 Different Sizes
 229 Total Pcs.
 Metric Hex Flange Bolt Assortment
 Sold Each



BACK OF TRAY

8631

**Bright Zinc Finish
Hammerlock Type
Cotter Pin Assortment**

4062  1/16 x 3/4" Bright Zinc Finish Hammerlock Type Cotter Pins	4063  2 1/16 x 1" Bright Zinc Finish Hammerlock Type Cotter Pins	4065  3 1/16 x 1 1/2" Bright Zinc Finish Hammerlock Type Cotter Pins	4069  4 3/32 x 3/4" Bright Zinc Finish Hammerlock Type Cotter Pins	4070  5 3/32 x 1" Bright Zinc Finish Hammerlock Type Cotter Pins	4108  6 3/16 x 2 1/2" Bright Zinc Finish Hammerlock Type Cotter Pins
4072  7 3/32 x 1 1/2" Bright Zinc Finish Hammerlock Type Cotter Pins	4074  8 3/32 x 2" Bright Zinc Finish Hammerlock Type Cotter Pins	4084  9 1/8 x 3/4" Bright Zinc Finish Hammerlock Type Cotter Pins	4086  10 1/8 x 1" Bright Zinc Finish Hammerlock Type Cotter Pins	4087  11 1/8 x 1 1/4" Bright Zinc Finish Hammerlock Type Cotter Pins	4112  12 1/4 x 1" Bright Zinc Finish Hammerlock Type Cotter Pins
4088  13 1/8 x 1 1/2" Bright Zinc Finish Hammerlock Type Cotter Pins	4089  14 1/8 x 1 3/4" Bright Zinc Finish Hammerlock Type Cotter Pins	4090  15 1/8 x 2" Bright Zinc Finish Hammerlock Type Cotter Pins	4091  16 1/8 x 2 1/2" Bright Zinc Finish Hammerlock Type Cotter Pins	4094  17 5/32 x 1" Bright Zinc Finish Hammerlock Type Cotter Pins	4114  18 1/4 x 1 1/2" Bright Zinc Finish Hammerlock Type Cotter Pins
4096  19 5/32 x 1 1/2" Bright Zinc Finish Hammerlock Type Cotter Pins	4098  20 5/32 x 2" Bright Zinc Finish Hammerlock Type Cotter Pins	4103  21 3/16 x 1" Bright Zinc Finish Hammerlock Type Cotter Pins	4105  22 3/16 x 1 1/2" Bright Zinc Finish Hammerlock Type Cotter Pins	4107  23 3/16 x 2" Bright Zinc Finish Hammerlock Type Cotter Pins	4116  24 1/4 x 2" Bright Zinc Finish Hammerlock Type Cotter Pins

FRONT OF TRAY

8531 (Metal Tray)

Shipped In a 24 Hole Gray Metal Tray

































8631 (Plastic Tray)

Shipped In a 24 Hole Gray Plastic Tray

Hammerlock Type
Bright Zinc Finish
Contains 24 Different Sizes
825 Total Pcs.
Cotter Pin Assortment
Sold Each



BACK OF TRAY

8633 Universal Import Door Rod End Clip Assortment							
10197 1 	10196 2 	10199 3 	10198 4 	10201 5 	10200 6 	10223 7 	10224 8 
10117 9 	10116 10 	10109 11 	10110 12 	10120 13 	10114 14 	10225 15 	10226 16 
10121 17 	10122 18 	10227 19 	10228 20 	10233 21 	10234 22 	10231 23 	10232 24 
10229 25 	10230 26 	10235 27 	10236 28 	10216 29 	10217 30 	10237 31 	10238 32 

FRONT OF TRAY

8633 (Plastic Tray)

Shipped In a 32 Hole Adjustable Gray Plastic Tray

8633YC (Plastic Tray)

Shipped In a 32 Hole Adjustable Yellow Plastic Tray

Covers Honda, Toyota, Nissan, Mazda

Cars & Trucks

Contains 32 Different Sizes

860 Total Pcs.

Door Rod End Clip Assortment

Sold Each



BACK OF TRAY

8633X
Universal Import
Door Rod End Clip
Assortment

10197 1 Left Hand Side Blue Nylon Nissan Rod End Clips	10196 2 Right Hand Side Orange Nylon Nissan Rod End Clips	10199 3 Left Hand Side Green Nylon Nissan Rod End Clips	10198 4 Right Hand Side Purple Nylon Nissan Rod End Clips	10201 5 Left Hand Side Natural Nylon Nissan Rod End Clips	10200 6 Right Hand Side Yellow Nylon Nissan Rod End Clips	10223 7 Left Hand Side Blue Nylon Mazda Rod End Clips	10224 8 Right Hand Side Black Nylon Mazda Rod End Clips
10117 9 Left Hand Side Yellow Nylon Toyota Rod End Clips	10116 10 Right Hand Side Natural Nylon Toyota Rod End Clips	10109 11 Left Hand Side Yellow Nylon Toyota Rod End Clips	10110 12 Right Hand Side Natural Nylon Toyota Rod End Clips	10120 13 Left Hand Side Natural Nylon Toyota Rod End Clips	10114 14 Left Hand Side Natural Nylon Honda Rod End Clips	10225 15 Left Hand Side Black Nylon Honda Rod End Clips	10226 16 Right Hand Side Brown Nylon Honda Rod End Clips
10121 17 Left Hand Side Brown Nylon Honda Rod End Clips	10122 18 Right Hand Side Blue Nylon Honda Rod End Clips	10227 19 Left Hand Side Natural Nylon Honda Rod End Clips	10228 20 Right Hand Side Purple Nylon Honda Rod End Clips	10233 21 Left Hand Side Blue Nylon Honda Rod End Clips	10234 22 Right Hand Side Pink Nylon Honda Rod End Clips	10231 23 Left Hand Side Yellow Nylon Honda Rod End Clips	10232 24 Right Hand Side Purple Nylon Honda Rod End Clips
10229 25 Left Hand Side Purple Nylon Honda Rod End Clips	10230 26 Right Hand Side Yellow Nylon Honda Rod End Clips	10235 27 Left Hand Side Brown Nylon Honda Rod End Clips	10236 28 Right Hand Side Blue Nylon Honda Rod End Clips	10216 29 Left Hand Side Purple Nylon Honda Rod End Clips	10217 30 Right Hand Side Orange Nylon Honda Rod End Clips	10237 31 Left Hand Side Black Nylon Honda Rod End Clips	10238 32 Right Hand Side Natural Nylon Honda Rod End Clips

FRONT OF TRAY

8633X (Plastic Tray)

Shipped In a 32 Hole Adjustable Gray Plastic Tray

Covers Honda, Toyota, Nissan, Mazda
Cars and Trucks
Contains 32 Different Sizes
425 Total Pcs.
Door Rod End Clip Assortment
Sold Each

*Color Sales Brochures Available. Call for Details.



BACK OF TRAY

8635 Wire Harness Pigtail Assortment							
<p>9773 1 12 18ga (SLX) Leads White (Grey Housing) Fuel Injector Plug</p>	<p>9779 2 13 Leads Yellow Brown Black (Black Housing) Light Socket Pigtail</p>	<p>9780 3 11 Leads Brown Black Grey Housing Light Socket Pigtail</p>	<p>1396 4 15 Leads 16ga Black (Black Housing) Headlamp Pigtail</p>	<p>9775 5 9 Leads Brown Black (Grey Housing) Marker & License Socket Pigtail</p>	<p>9909 6 12ga (TKL) 8 Leads Green Red (Black Housing) Brake Light Socket Pigtail</p>	<p>9908 7 12 16ga (TKL) 8 Leads Orange Yellow (Grey Housing) Alternator Harness Pigtail</p>	<p>9907 8 14ga (TKL) 8 Leads Black (Black Housing) Alternator Harness Pigtail</p>
<p>9776 9 16 Leads 11 14ga 12 20ga Green White Blue (Grey Housing) Voltage Regulator Pigtail</p>	<p>9778 10 16 Leads 11 16ga 12 16ga 12 12ga Yellow Green Orange Black (Black Housing) Heater & A/C Fan Speed Pigtail</p>	<p>9813 11 16 Leads 10 12 14 16ga Second 11 18 20ga Lead White Housing Driver Motor Resistor Pigtail</p>	<p>9800 12 8 Leads 14ga Yellow Green Orange Black (Black Housing) A/C Blower Motor Resistor Pigtail</p>	<p>9774 13 11ga (TKL) Leads Brown Black Green Gold Black Housing 12ga Horn & Park Light Pigtail</p>	<p>9767 14 8 12ga Leads White Black Housing Vehicle Speed Sensor Pigtail</p>	<p>9768 15 10 Leads 12 16ga Black-Orange 11 20ga White (Black Housing) Alternator Speed Assembly Pigtail</p>	
<p>9769 16 Grey Housing A/C Clutch Field Coil Connector Pigtail</p>		<p>9770 17 8 Leads 12ga Lead Red White Green Orange Black (Black Housing) Heater & A/C Blower Switches Repair Pigtail</p>	<p>9771 18 12 Leads Green & Green/Gold (Black Housing) Power Blower Connector Pigtail</p>		<p>9798 19 14ga 12 12ga (OPT) 8 Leads Turn Signal & Wiper Field Wiper Pigtail</p>		
<p>9777 20 10 8 Leads 16ga (OPT) Grey Housing Turn Signal & Wiper Field Wiper Repair Pigtail</p>		<p>9772 21 8 Leads 12 20ga 11 16ga 11 12ga 12 12ga Grey Housing Dash Mounted Headlamp Switch Repair Pigtail</p>	<p>9799 22 11 10ga (TKL) 8 Leads Grey Housing Multi-Function Switch Pigtail</p>		<p>9834 23 8 10ga (OPT) 6 Leads Grey Housing Multi-Function Switch Pigtail</p>		

FRONT OF TRAY

12











8635 (Plastic Tray)

Shipped In an Adjustable Gray Plastic Tray

Covers G.M., Ford & Nissan
Cars & Trucks
Contains 23 Different Sizes
30 Total Pcs.
Wire Harness Assortment
Sold Each



BACK OF TRAY

















8637 Ergo Tufloks Push-Type Retainer Assortment					
 10366 6.5mm Hole Size 18mm Flange Size 2.2-4.5mm Panel Range Black Nylon Push-Type Retainers	1	 10371 6.5mm Hole Size 23mm Flange Size 2.0-5.0mm Panel Range Black Nylon Push-Type Retainers	2	 10375 9.5mm Hole Size 18mm Flange Size 2.55-5.75mm Panel Range Black Nylon Push-Type Retainers	3
 10369 6.5mm Hole Size 18mm Flange Size 4.2-7.0mm Panel Range Black Nylon Push-Type Retainers	4	 10239 6.5mm Hole Size 19mm Flange Size 2.0-5.0mm Panel Range Black Nylon Push-Type Retainers	5	 10377 10.5mm Hole Size 25mm Flange Size 3.0-6.0mm Panel Range Black Nylon Push-Type Retainers	6
 10367 6.5mm Hole Size 18mm Flange Size 7.0-9.0mm Panel Range Black Nylon Push-Type Retainers	7	 10374 6.5mm Hole Size 23mm Flange Size 4.0-7.0mm Panel Range Black Nylon Push-Type Retainers	8	 10378 10.5mm Hole Size 25mm Flange Size 6.0-9.0mm Panel Range Black Nylon Push-Type Retainers	9
 10370 9mm Hole Size 18mm Flange Size 2.0-3.0mm Panel Range Black Nylon Push-Type Retainers	10	 10372 6.5mm Hole Size 23mm Flange Size 0-10.0mm Panel Range Black Nylon Push-Type Retainers	11		12

FRONT OF TRAY

8637 (Plastic Tray)
 Shipped In an Adjustable Gray Plastic Tray
8637YC (Plastic Tray)
 Shipped In an Adjustable Yellow Plastic Tray

Covers 6.5mm to 10mm Hole Sizes
 Black Nylon
 Contains 11 Different Sizes
 280 Total Pcs.
 Ergo Tufloks Retainer Assortment
 Sold Each



BACK OF TRAY					
# 8639 Toyota Nuts, Gromets & Retainer Assortment					
# 9591 1  8 Screw Size Head Diameter: 16mm Stem Length: 13mm, 7mm Square Hole Natural Nylon Screw Grommets	# 1614 2  10 Screw Size Flt. & 8.5mm Square Hole Natural Nylon Screw Grommets	# 1560 3  10 Screw Size Head Size: 8mm x 8mm Natural Nylon Headlamp Bracket & Grille Nuts	# 1576 4  10 Screw Size Head Diameter: 10mm Stem Length: 17mm Natural Nylon Screw Grommets	# 9912 5  12 Screw Size, 10mm Square Hole Black Nylon Front & Rear Wheel Fender Liner Screw Grommets	# 1605 6  1/4" (6.4) Screw Size Head Diameter: 20mm Stem Length: 17mm Black Nylon Screw Grommets
# 1466 8  7mm Hole Size Head Diameter: 13mm Stem Length: 13mm Black Nylon Retaining Clips	# 1996 9  7mm Hole Size Head Diameter: 13mm Stem Length: 13mm Black Nylon Retaining Clips	# 10141 10  7mm Hole Size Head Diameter: 20mm Stem Length: 10mm Black Nylon Head Insulation Retainers	# 9328 11  7mm Hole Size 17mm Stem Length 20mm Head Diameter Black Nylon Head Insulation Retainers	# 1550 12  7mm Hole Size Head Diameter: 20mm Stem Length: 17mm Black Nylon Retaining Clips	
# 2145 13  8mm Hole Size, Small Hd., 13mm Large Hd., 16mm Stem Length, 13mm Natural Nylon Door Trim & Garnish Retainers	# 9081 14  8mm Hole Size Top Head Diameter: 13mm Stem Length: 16mm White Nylon Retaining Retainers	# 1603 15  7mm Hole Size Head Diameter: 15mm Stem Length: 12mm Black Nylon Retaining Retainers	# 2027 16  8mm Hole Size Head Diameter: 15mm Stem Length: 12mm Black Nylon Bumper Cover Push-Type Retainer	# 9465 17  7mm Hole Size Hd Dia.: 20mm, Stem Length: 8mm Black Nylon Front Fender Liner Push-Type Retainers	# 9327 18  8mm Hole Size Hd Dia.: 18mm Stem Length, 28mm Rear Bumper Cover Black Nylon Retaining Retainers
# 9946 19  8mm Hole Size Head Diameter: 17mm Red Nylon Fender Moulding Clips	# 10113 20  8mm Hole Size Head Diameter: 17mm Blue Nylon Fender Moulding Clips	# 10112 21  8mm Length: 17mm, Head Diameter: 17mm Yellow Nylon Fender & Wheel Flare Moulding Clips		# 1606 23  14 (1/4) Screw Size Panel Range: Up to 1mm Center Of Hole To Edge: 15mm Black Nylon Wheel Housing "U" Nuts	# 1601 24  10 Screw Size Panel Range: Up to 1mm Center Of Hole To Edge: 15mm Black Nylon "U" Type Retainers
FRONT OF TRAY					

8539 (Metal Tray)
Shipped In a 24 Hole Gray Metal Tray

8639 (Plastic Tray)
Shipped In a 24 Hole Gray Plastic Tray

Covers Nuts, Grommets & Retainers
Toyota Cars
Contains 22 Different Sizes
430 Total Pcs.
Nut, Grommet & Retainer Assortment
Sold Each

*Color Sales Brochures Available. Call for Details.

































12



BACK OF TRAY

8645

**Phillips Oval Head
Chrome Sheet Metal
Screw Assortment**

 8 x 3/8" #6 Head Sheet Metal Screws	 8 x 1/2" #6 Head Sheet Metal Screws	 8 x 3/4" #6 Head Sheet Metal Screws	 8 x 1" #6 Head Sheet Metal Screws	 8 x 1 1/4" #6 Head Sheet Metal Screws	 8 x 1 1/2" #6 Head Sheet Metal Screws	 8 x 1 3/4" #6 Head Sheet Metal Screws	 10 x 1/2" #6 Head Sheet Metal Screws
 10 x 3/4" #6 Head Sheet Metal Screws	 10 x 1" #6 Head Sheet Metal Screws	 10 x 1 1/4" #6 Head Sheet Metal Screws	 10 x 1 1/2" #6 Head Sheet Metal Screws	 10 x 1 3/4" #6 Head Sheet Metal Screws	 10 x 1 1/2" #6 Head Sheet Metal Screws	 10 x 3/4" #6 Head Sheet Metal Screws	 10 x 1" #6 Head Sheet Metal Screws
 10 x 1 1/4" #6 Head Sheet Metal Screws	 8 x 1/2" #6 Head Sheet Metal Screws	 8 x 3/4" #6 Head Sheet Metal Screws	 8 x 1" #6 Head Sheet Metal Screws	 8 x 1 1/4" #6 Head Sheet Metal Screws	 8 x 3/8" #6 Head Sheet Metal Screws	 8 x 1/2" #6 Head Sheet Metal Screws	 8 x 3/4" #6 Head Sheet Metal Screws
 8 x 1" #6 Head Sheet Metal Screws	 8 x 1 1/4" #6 Head Sheet Metal Screws	 8 x 1 1/2" #6 Head Sheet Metal Screws	 8 x 1 1/2" #6 Head Sheet Metal Screws	 10 x 3/4" #10 Head Sheet Metal Screws	 10 x 1" #10 Head Sheet Metal Screws	 10 x 1 1/4" #10 Head Sheet Metal Screws	 10 x 1 1/2" #10 Head Sheet Metal Screws

FRONT OF TRAY

8645 (Plastic Tray)

Shipped In a 32 Hole Gray Plastic Tray

Phillips Oval Head
Chrome Finish
Contains 32 Different Sizes
1510 Total Pcs.
Phillips Oval Head Sheet Metal Screw Assortment
Sold Each

*Color Sales Brochures Available. Call for Details.

NEW!



BACK OF TRAY					
8647 Universal Nylon Rivet Assortment With Tool					
1374 1 5/32" (4mm) Hole Size Rectangle Flange Q.R. 118" - 13/32" Black Nylon Blind Rivets	5768 2 3/16" (4.75mm) Hole Size Flange Size 11/32" Q.R. 5/32" - 1/4" Black Nylon Blind Rivets	9053 3 13/64" (5.15mm) Hole Size Flange Size 15/32" Q.R. 1/16" - 11/64" Black Nylon Blind Rivets	10565 4 13/64" (5.15mm) Hole Size Flange Size 11/32" Q.R. 1/8" - 5/32" Black Nylon Blind Rivets	5769 5 3/16" (4.75mm) Hole Size Flange Size 15/32" Q.R. 1/8" - 1/4" Black Nylon Blind Rivets	1204 21  Not Actual Size
1195 6 3/16" (4.75mm) Hole Size Flange Size 15/32" Q.R. 1/8" - 25/64" Black Nylon Blind Rivets	2080 7 15/64" (5.35mm) Hole Size Flange Size 1/2" Q.R. 1/8" - 1/32" Black Nylon Blind Rivets	9854 8 15/64" (5.35mm) Hole Size Flange Size 5/8" Q.R. 3/32" - 5/16" Black Nylon Blind Rivets	10563 9 1/4" (6.35mm) Hole Size Flange Size 21/32" Q.R. 1/32" - 1/4" Black Nylon Blind Rivets	10564 10 1/4" (6.35mm) Hole Size Flange Size 21/32" Q.R. 1/32" - 1/4" Black Nylon Blind Rivets	
10562 11 1/4" (6.35mm) Hole Size Flange Size 21/32" Q.R. 1/32" - 1/4" Black Nylon Blind Rivets	10560 12 1/4" (6.35mm) Hole Size Flange Size 1/2" Q.R. 5/32" - 9/32" Black Nylon Blind Rivets	10551 13 1/4" (6.35mm) Hole Size Flange Size 11/16" Q.R. 5/32" - 3/8" Gray Nylon Blind Rivets	1390 14 1/4" (6.35mm) Hole Size Flange Size 1/2" Q.R. 5/32" - 13/32" Black Nylon Blind Rivets	5770 15 1/4" (6.35mm) Hole Size Flange Size 43/64" Q.R. 5/32" - 1/32" Black Nylon Blind Rivets	
9128 16 1/4" (6.35mm) Hole Size Flange Size 43/64" Q.R. 5/16" - 1/32" Black Nylon Blind Rivets	9054 17 1/4" (6.35mm) Hole Size Flange Size 1/2" Q.R. 5/32" - 3/16" Black Nylon Blind Rivets	5775 18 13/64" (5.15mm) Hole Size Flange Size 45/64" Q.R. 3/32" - 3/16" Black Nylon Blind Rivets	1467 19 9/32" (7.14mm) Hole Size Flange Size 23/32" Q.R. 5/32" - 1/4" Black Nylon Blind Rivets	10630 20 1/4" (6.35mm) Hole Size Flange Size 21/32" Q.R. 5/32" - 1/32" Black Nylon Blind Rivets	6 1/2" Long Use for All Size Rivets Use Nylon Rivets Only Single Stroke Rivet Setter Gun
FRONT OF TRAY					

12

8647 (Plastic Tray)

Shipped In a 21 Hole Gray Plastic Tray

Covers 4mm to 6.35mm Hole Sizes
All Nylon With Tool
Contains 20 Different Sizes
260 Total Pcs.
Nylon Pop Rivet Assortment
Sold Each

*Color Sales Brochures Available. Call for Details.



BACK OF TRAY

8649
Universal
Nylon Rivet
Assortment

1374 1	5768 2	9053 3	10565 4	5769 5	1195 6	2080 7	9854 8
5/32" (4mm) Hole Size Rectangle Flange GR: 14" - 13/32" Black Nylon Blind Rivets	3/16" (4.75mm) Hole Size Flange Size 11/32" GR: 3/2" - 1/4" Black Nylon Blind Rivets	13/64" (5.15mm) Hole Size Flange Size 13/32" GR: 1/16" - 11/64" Black Nylon Blind Rivets	13/64" (5.15mm) Hole Size Flange Size 11/32" GR: 1/8" - 5/32" Black Nylon Blind Rivets	3/16" (5mm) Hole Size Flange Size 13/32" GR: 1/8" - 15/64" Black Nylon Blind Rivets	3/16" (5mm) Hole Size Flange Size 15/32" GR: 15/64" - 25/64" Black Nylon Blind Rivets	15/64" (5.31mm) Hole Size Flange Size 1/2" GR: 11/64" - 11/32" Black Nylon Blind Rivets	15/64" (5.5mm) Hole Size Flange Size 3/4" GR: 5/32" - 5/16" Black Nylon Blind Rivets
10563 9	10564 10	10562 11	10560 12				
1/4" (6.35mm) Hole Size Flange Size 21/32" GR: 1/32" - 11/64" Black Nylon Blind Rivets	1/4" (6.35mm) Hole Size Flange Size 21/32" GR: 1/32" - 3/16" Black Nylon Blind Rivets	1/4" (6.35mm) Hole Size Flange Size 21/32" GR: 5/32" - 1/4" Black Nylon Blind Rivets	1/4" (6.35mm) Hole Size Flange Size 1/2" GR: 5/32" - 9/32" Black Nylon Blind Rivets				
10561 13	1390 14	5770 15	9128 16				
1/4" (6.35mm) Hole Size Flange Size 11/16" GR: 5/32" - 3/8" Grey Nylon Blind Rivets	1/4" (6.35mm) Hole Size Flange Size 1/2" GR: 5/32" - 13/32" Black Nylon Blind Rivets	1/4" (6.35mm) Hole Size Flange Size 43/64" GR: 5/32" - 13/32" Black Nylon Blind Rivets	1/4" (6.35mm) Hole Size Flange Size 43/64" GR: 5/16" - 15/32" Black Nylon Blind Rivets				
9054 17	5775 18	1467 19	10630 20				
1/4" (6.35mm) Hole Size Flange Size 1/2" GR: 5/32" - 3/16" Black Nylon Blind Rivets	17/64" (6.6mm) Hole Size Flange Size 45/64" GR: 5/32" - 3/16" Black Nylon Blind Rivets	9/32" (7.14mm) Hole Size Flange Size 23/32" GR: 5/32" - 15/64" Black Nylon Blind Rivets	1/4" (6.35mm) Hole Size Flange Size 21/32" GR: 5/32" - 3/8" Black Nylon Blind Rivets				

8649 (Plastic Tray)
Shipped In an Adjustable Gray Plastic Tray

Covers 4mm to 6.35mm Hole Sizes
All Nylon
Contains 20 Different Sizes
355 Total Pcs.
Nylon Pop Rivet Assortment
Sold Each

*Color Sales Brochures Available. Call for Details.

NEW!



BACK OF TRAY

8651 Universal All Aluminum Rivet Assortment With Tool					
10585 1	1888 2	1889 3	1890 4	1891 5	1146 21  Not Actual Size 10" Overall Length Has Nose pieces for 3/32, 1/8, 5/32 & 3/16" Dia. Rivets Hand Riveter
10592 6	10593 7	9572 8	1899 9	1900 10	
1901 11	1902 12	10597 13	10588 14	9596 15	
10124 16	10594 17	1903 18	1904 19	1905 20	

FRONT OF TRAY

12

8651 (Plastic Tray) Shipped In a 21 Hole Gray Plastic Tray

Covers 3/32" to 3/16" Hole Sizes
All Aluminum With Tool
Contains 20 Different Sizes
636 Total Pcs.
All Aluminum Pop Rivet Assortment
Sold Each

*Color Sales Brochures Available. Call for Details.



BACK OF TRAY

8653
Universal
All Aluminum Rivet
Assortment

9243	1799	10585	10586	10587	1888	10589	1889
1/8" (3.175mm) Hole Size Flange Size 1/4" GR: 3/16" - 1/4" Black Finish All Aluminum	1/8" (3.175mm) Hole Size Flange Size 3/16" GR: 1/8" - 3/16" Black Finish All Aluminum	3/32" (2.381mm) Hole Size Flange Size 3/16" GR: 1/8" - 1/4" All Aluminum	3/32" (2.381mm) Hole Size Flange Size 2x 3/16" GR: 1/8" - 1/4" All Aluminum	1/8" (3.175mm) Hole Size Flange Size 1/4" GR: 1/32" - 5/16" All Aluminum	1/8" (3.175mm) Hole Size Flange Size 1/4" GR: 1/16" - 1/8" All Aluminum	1/8" (3.175mm) Hole Size Flange Size 1/4" GR: 5/8" - 3/16" All Aluminum	1/8" (3.175mm) Hole Size Flange Size 1/4" GR: 3/16" - 1/4" All Aluminum
10590	1890	1891	10592	10593	9572	10595	10596
1/8" (3.175mm) Hole Size Flange Size 1/4" GR: 1/4" - 5/16" All Aluminum	1/8" (3.175mm) Hole Size Flange Size 1/4" GR: 1/16" - 3/8" All Aluminum	1/8" (3.175mm) Hole Size Flange Size 1/4" GR: 3/8" - 1/2" All Aluminum	5/32" (3.96mm) Hole Size Flange Size 5/16" GR: 1/16" - 1/8" All Aluminum	5/32" (3.96mm) Hole Size Flange Size 5/16" GR: 1/8" - 5/16" All Aluminum	5/32" (3.96mm) Hole Size Flange Size 5/16" GR: 1/4" - 1/4" All Aluminum	5/32" (3.96mm) Hole Size Flange Size 5/16" GR: 1/4" - 3/8" All Aluminum	5/32" (3.96mm) Hole Size Flange Size 5/16" GR: 3/8" - 1/2" All Aluminum
1899	1900	1901	1902	10597	10599	10588	9596
3/16" (4.763mm) Hole Size Flange Size 3/8" GR: 1/8" - 1/8" All Aluminum	3/16" (4.763mm) Hole Size Flange Size 3/8" GR: 1/8" - 1/4" All Aluminum	3/16" (4.763mm) Hole Size Flange Size 3/8" GR: 1/4" - 3/8" All Aluminum	3/16" (4.763mm) Hole Size Flange Size 3/8" GR: 3/8" - 1/2" All Aluminum	3/16" (4.763mm) Hole Size Flange Size 3/8" GR: 1/2" - 5/8" All Aluminum	3/16" (4.763mm) Hole Size Flange Size 3/8" GR: 3/8" - 3/4" All Aluminum	1/8" (3.175mm) Hole Size Flange Size 3/8" GR: 1/8" - 1/8" All Aluminum	1/8" (3.175mm) Hole Size Flange Size 3/8" GR: 3/16" - 1/4" All Aluminum
10124	10594	1903	1904	1905	10598		
1/8" (3.175mm) Hole Size Flange Size 3/8" GR: 3/8" - 3/8" All Aluminum	5/32" (3.96mm) Hole Size Flange Size 15/32" GR: 3/16" - 1/4" All Aluminum	3/16" (4.763mm) Hole Size Flange Size 5/8" GR: 1/8" - 1/4" All Aluminum	3/16" (4.763mm) Hole Size Flange Size 5/8" GR: 1/4" - 3/8" All Aluminum	3/16" (4.763mm) Hole Size Flange Size 5/8" GR: 3/8" - 5/8" All Aluminum	3/16" (4.763mm) Hole Size Flange Size 5/8" GR: 1/2" - 5/8" All Aluminum		

FRONT OF TRAY

8653 (Plastic Tray)
Shipped In an Adjustable Gray Plastic Tray

Covers 3/32" to 3/16" Hole Sizes
All Aluminum
Contains 30 Different Sizes
885 Total Pcs.
All Aluminum Pop Rivet Assortment
Sold Each

*Color Sales Brochures Available. Call for Details.



BACK OF TRAY

8655
Universal
Automotive Rivet
Assortment

9454 1	9893 2	9118 3	9243 4	1799 5	9277 6	9718 7	9453 8
1/8" (mm) Hole Size Flange Size 3/16" GR: 316 - 14 Black Finish All Aluminum	1/8" (mm) Hole Size Flange Size 3/16" GR: 18 - 316 Stainless Steel/Steel	1/8" (mm) Hole Size Flange Size 3/16" GR: 116 - 18 Black Finish Alum./Steel	1/8" (mm) Hole Size Flange Size 1/4" GR: 316 - 14 All Alum. Black Finish	1/8" (mm) Hole Size Flange Size 3/8" GR: 18 - 316 Black Finish Alum./Steel	5/32" (mm) Hole Size Flange Size 15/32" GR: 18 - 14 Black Finish Alum./Steel	3/16" (mm) Hole Size Flange Size 3/8" GR: 116 - 1754 All Steel Black Finish	3/16" (mm) Hole Size Flange Size 3/8" GR: 316 - 12 All Alum. Black Finish
9278 9	4005 10	4009 14	4007 15	9618 12	9885 13	9902 16	9644 17
3/16" (mm) Hole Size Flange Size 3/8" GR: 364 - 1132 Black Alum. Spin-Type Rivets	3/16" (mm) Hole Size Flange Size 3/8" GR: 312 - 12 All Alum. Black Finish	1/4" (8.35mm) Hole Size Flange Size 1/2" GR: 312 - 18 Aluminum/Steel	1/4" (8.35mm) Hole Size Flange Size 1/2" GR: 112 - 1564 Aluminum/Steel	3/16" (mm) Hole Size Flange Size 3/4" GR: 116 - 1316 All Aluminum	1/4" (8.35mm) Hole Size Flange Size 1/2" GR: 364 - 1132 Grey Nylon Blind Rivets	1/4" (8.35mm) Hole Size Flange Size 1/2" GR: 964 - 318 Aluminum/Steel	1/4" (8.35mm) Hole Size Flange Size 19/32" Shoulder 13/32" GR: 364 - 314 All Steel Bright Zinc Finish
4002 18	4008 19	1951 20	FRONT OF TRAY				
1/4" (8.35mm) Hole Size Flange Size 3/4" GR: 18 - 14 All Steel Black Finish	1/4" (8.35mm) Hole Size Flange Size 1/2" GR: 364 - 1532 Aluminum/Steel	1/4" (8.35mm) Hole Size Flange Size 11/8" GR: 316 - 318 Aluminum/Steel Black Finish					

12

8655 (Plastic Tray)
Shipped In an Adjustable Gray Plastic Tray

Covers 1/8" to 1/4" Hole Sizes
Aluminum Steel Rivets
Contains 20 Different Sizes
375 Total Pcs.
Automotive Pop Rivet Assortment
Sold Each

*Color Sales Brochures Available. Call for Details.



BACK OF TRAY

8657 Blade Type Fuse Assortment								
1734 5 Amp Orange Blade Type Type ATM Mini Fuses	1735 7.5 Amp Brown Blade Type Type ATM Mini Fuses	1736 10 Amp Red Blade Type Type ATM Mini Fuses	1737 15 Amp Blue Blade Type Type ATM Mini Fuses	1738 20 Amp Yellow Blade Type Type ATM Mini Fuses	1739 25 Amp White Blade Type Type ATM Mini Fuses	1740 30 Amp Green Blade Type Type ATM Mini Fuses	8	
1709 5 Amp Orange Blade Type Type ATO Standard Fuses	1710 7.5 Amp Brown Blade Type Type ATO Standard Fuses	1711 10 Amp Red Blade Type Type ATO Standard Fuses	1712 15 Amp Blue Blade Type Type ATO Standard Fuses	1713 20 Amp Yellow Blade Type Type ATO Standard Fuses	1714 25 Amp White Blade Type Type ATO Standard Fuses	1715 30 Amp Green Blade Type Type ATO Standard Fuses	16	
1786 30 Amp Green Blade Type Type ATX Maxi Fuses	1787 40 Amp Orange Blade Type Type ATX Maxi Fuses	1788 50 Amp Red Blade Type Type ATX Maxi Fuses	1789 60 Amp Blue Blade Type Type ATX Maxi Fuses					20

FRONT OF TRAY

8657 (Plastic Tray)

Shipped In an Adjustable Gray Plastic Tray

Covers 5 AMP to 60 AMP
Blade Type
Contains 19 Different Sizes
305 Total Pcs.
Blade Fuse Assortment
Sold Each

*Color Sales Brochures Available. Call for Details.



BACK OF TRAY

8659
Universal
Hood Insulation Retainers
& Hood Seal Clips
Assortment

<p>9262 1</p> <p>6mm Hole Size Head Diameter: 12mm Black Nylon Honda Hood & Trunk Moulding Clips</p>	<p>9520 2</p> <p>5/16" (8mm) Hole Size Head Diameter: 5/8" Black Nylon G.M. Hood Seal Retainers</p>	<p>9522 3</p> <p>6mm Hole Size Head Diameter: 14mm Black Nylon Ford Hood Insulation Ret.</p>	<p>10462 4</p> <p>7mm Hole Size Head Diameter: 12.5mm Black Nylon G.M. Hood Insulation Ret.</p>	<p>10613 5</p> <p>4.75mm Hole Size Head Diameter: 19mm Black Nylon Ford Hood Insulation Ret.</p>	<p>1930 6</p> <p>1/4" (6.4mm) Hole Size Head Diameter: 1 21/32" (43.65mm) Black Nylon G.M. Hood Insulation Ret.</p>
<p>10141 7</p> <p>7mm Hole Size Head Diameter: 22mm Black Nylon Toyota Hood Insulation Ret.</p>	<p>10391 8</p> <p>6.3mm Hole Size Head Diameter: 22.4mm Black Nylon Chrysler Hood Insulation Ret.</p>	<p>2025 9</p> <p>5.5mm Hole Size Head Diameter: 29.4mm Black Nylon Nissan Hood Insulation Ret.</p>	<p>9980 10</p> <p>6.3mm Hole Size Head Diameter: 20mm Black Nylon Chrysler Hood Insulation Ret.</p>	<p>10379 11</p> <p>6mm Hole Size Head Diameter: 30mm Black Nylon Honda Hood Insulation Ret.</p>	<p>5440 12</p> <p>1/4" (6.4mm) Hole Size Head Diameter: 2" (50.8mm) Black Polypropylene G.M. Hood Insulation Ret.</p>
<p>969 13</p> <p>6mm Hole Size Head Diameter: 37.5mm Black Nylon Ford Hood Insulation Ret.</p>	<p>2167 14</p> <p>6.3mm Hole Size Head Diameter: 30mm Black Nylon G.M. Hood Insulation Ret.</p>	<p>1950 15</p> <p>7mm Hole Size Head Diameter: 30mm Black Nylon Toyota Hood Insulation Ret.</p>	<p>9588 16</p> <p>8mm Hole Size Head Diameter: 30mm Black Nylon Ford Hood Insulation Ret.</p>	<p>9328 17</p> <p>7mm Hole Size Head Diameter: 30mm Black Nylon Toyota Hood Insulation Ret.</p>	<p>5440 18</p> <p>1/4" (6.4mm) Hole Size Head Diameter: 2" (50.8mm) Black Polypropylene G.M. Hood Insulation Ret.</p>
<p>9945 19</p> <p>7.5mm Hole Diameter Head Diameter: 37.5mm Black Nylon Acura Hood Insulation Ret.</p>	<p>2111 20</p> <p>6.3mm Hole Size Head Diameter: 32mm Black Nylon Ford Hood Insulation Ret.</p>	<p>1929 21</p> <p>6.3mm Hole Size Head Diameter: 1 3/8" (35mm) Black Polypropylene G.M. Hood Insulation Ret.</p>	<p>10393 22</p> <p>7.1mm Hole Size Head Diameter: 40mm Black Nylon G.M. Hood Insulation Ret.</p>	<p>9513 23</p> <p>6.4mm Hole Size Head Diameter: 1 5/8" (44.5mm) Black Nylon Ford Hood Insulation Ret.</p>	<p>1573 24</p> <p>7.5mm Hole Size Head Diameter: 44.5mm Black Nylon Ford Hood Insulation Ret.</p>

FRONT OF TRAY

8559 (Metal Tray)
Shipped In a 24 Hole Gray Metal Tray

8659 (Plastic Tray)
Shipped In a 24 Hole Gray Plastic Tray

Covers 6mm to 7.5mm Hole Sizes
Black Nylon
Contains 24 Different Sizes
331 Total Pcs.
Hood Seal & Insulation Ret. Assortment
Sold Each

*Color Sales Brochures Available. Call for Details.



BACK OF TRAY

8661
License Plate Screw & Nut Assortment

 9838 6 - 1.00mm 10mm Hex Size Black Nylon License Plate Hex Nuts	 9839 6 - 1.00 x 16mm Slotted Pan Head Black Nylon License Plate Screws	 9840 6 - 1.00 x 20mm Slotted Pan Head Black Nylon License Plate Screws	 10095 6 - 1.00 x 20mm Phillips Pan Head Black Nylon License Plate Screws				
 1228 1/4" (R14) Screw Size White Plastic License Plate Nuts	 2123 1/4" (R14) x 3/4" 10mm Indented Hex 12mm O.D. Washer Head Phillips Yellow Zinc Finish License Plate Screws	 1620 1/4" x 3/4" 3/8" Indented Hex Size 1/2" O.D. Washer Head Slotted Bright Zinc Finish License Plate Screws	 9934 1/4" (R14) x 3/4" 3/8" Indented Hex 1/2" O.D. Washer Head Slotted Black Finish License Plate Screws				
 9494 1/4" (R14) Screw Size Natural Nylon License Plate Nuts	 2121 1/4" (R14) x 3/4" 9/16" Head Diameter Phillips Truss Head Zinc Plated License Plate Screws	 477 1/4" (R14) x 3/4" 9/16" Head Diameter Slotted Truss Head Zinc Plated License Plate Screws	 2062 1/4" (R14) x 3/4" 9/16" Head Diameter Slotted Truss Head Black Finish License Plate Screws				
 2136 6 - 1.00 x 12mm Phillips Pan Head Bright Zinc Finish Machine Screws	 1851 6 - 1.00 x 16mm Phillips Pan Head Bright Zinc Finish Machine Screws	 9168 6 - 1.00 x 20mm Phillips Pan Head Bright Zinc Finish Machine Screws	 2124 6 - 1.00 x 16mm Slotted Hex Washer Head Bright Zinc Finish License Plate Screws	 10455 6-3.181 x 16mm Duo-Drive Truss Head Silver Dacromet Finish License Plate Screws	 1939 1/4" (R14) x 3/8" 5/8" O.D. Washer 5/16" Indented Hex Head Slotted Black Finish License Plate Screws	 10514 1/4-20 x 3/4" 5/16" Head Diameter Slotted Truss Head Zinc Plated License Plate Screws	 9882 1/4-20 x 3/8" Truss Slot Washer Head 1932" O.D. Washer Black Nylon License Plate Screws

FRONT OF TRAY

8661 (Plastic Tray)

Shipped In an Adjustable Gray Plastic Tray

Covers 1/4" and 6mm
Nylon & Metal Nuts & Screws
Contains 20 Different Sizes
520 Total Pcs.
License Plate Nut & Screw Assort
Sold Each

*Color Sales Brochures Available. Call for Details.



BACK OF TRAY					
# 8663					
Universal Hyundai Retainer Assortment					
# 10767 1 6.5mm Hole Size Head Diameter: 4.8mm x 13mm Stem Length: 15mm Black Nylon Hood Weatherstripping Molding Clips	# 10766 2 6.5mm Hole Size Head Diameter: 8mm x 16mm Stem Length: 16mm Black Nylon Hood Weatherstripping Molding Clips	# 10773 3 8mm Hole Size Top Head Diameter: 13mm Stem Length: 13mm Gray Nylon Trim Panel Retainers	# 10774 4 8mm Hole Size Top Head Diameter: 15mm Stem Length: 15mm Black Nylon Door Trim Panel Retainers	# 10744 5 8mm Hole Size Top Head Diameter: 13mm Stem Length: 13mm Natural Nylon Trim Panel Retainers	# 10785 6 #6 Screw Size Inside Edge to Center of Hole: 8mm 16mm wide 23mm long Black Nylon Wheel Guard "U" Nuts
# 10780 7 9.5mm x 12mm Hole Size Top Head Diameter: 10mm x 11mm Stem Length: 15mm Yellow Nylon Rocker Molding Clips w/ Sealer	# 10770 8 8.5 x 12mm Hole Size Top Head Diameter: 10mm x 20mm Stem Length: 15mm Yellow Nylon Rocker Panel Clips w/ Sealer	# 10784 9 8.5mm x 12mm Hole Size Top Head Diameter: 8mm x 9mm Stem Length: 15mm Black Nylon Body Side Molding Clips w/ Sealer	# 10769 10 8.5 x 12mm Hole Size Top Head Diameter: 10mm x 12mm Stem Length: 15mm White Nylon Molding Clips w/ Sealer	# 10655 11 6.3mm Hole Size Flange Size: 15mm Stem Length: 8mm Black Nylon Push Type Retainers	# 9287 12 5/16" (8mm) Hole Size Flange Size: 15mm Stem Length: 12mm Black Nylon Push Type Retainers
# 10772 13 8mm Hole Size Flange Size: 18mm Stem Length: 12mm Black Nylon Push Type Retainers	# 10783 14 4.2mm Screw Size Flange Size: 8mm x 12mm Hole 14mm Square HC 16mm Stem Length White Nylon Body Side Molding Clips w/ Sealer	# 10779 15 4.2mm Screw Size Hole Size: 8 x 10mm Stem Length: 14mm White Nylon Fender & Rocker Molding Nuts w/ Sealer	# 10771 16 4.8mm (#10) Screw Size 8.5mm Square Hole 15mm Head Dia. 8mm Stem Yellow Nylon Interior Trim Components	# 10781 17 16mm Hole Size Head Diameter: 15mm Stem Length: 8mm Natural Nylon Headlight Assembly Components	# 10782 18 8mm Hole Size Head Diameter: 26mm Stem Length: 16mm Black Nylon Head Inflation Retainer
# 10775 19 5.5mm (#12) Screw Size Flange Size: 13mm 13mm Head 8.5mm Stem White Nylon Rocker Molding Nuts	# 10776 20 14mm Base Diameter Small Head: 8mm x 16mm Overall Height: 6mm Black Nylon Body Side Molding Clips	# 10777 21 4.8 (#10) Screw Size Flange Size: 8.5mm Square Hole 16mm Head Dia. 11mm Stem Black Nylon Fender Apron Nuts	# 10796 22 4.8mm (#10) Screw Size Head Size: 12mm x 12mm Stem Length: 11mm White Nylon Front and Rear Damper & Fender Nuts	# 10778 23 Width: 13mm Length: 30mm Black Steel Bumper & Grille Retainers	# 10778 24
FRONT OF TRAY					

8563 (Metal Tray)

Shipped In a 24 Hole Gray Metal Tray

8663 (Plastic Tray)

Shipped In a 24 Hole Gray Plastic Tray

Covers Door Panel & Grommets

Nylon & Metal Retainers

Contains 23 Different Sizes

405 Total Pcs.

Hyundai Retainer Assortment

Sold Each

*Color Sales Brochures Available. Call for Details.

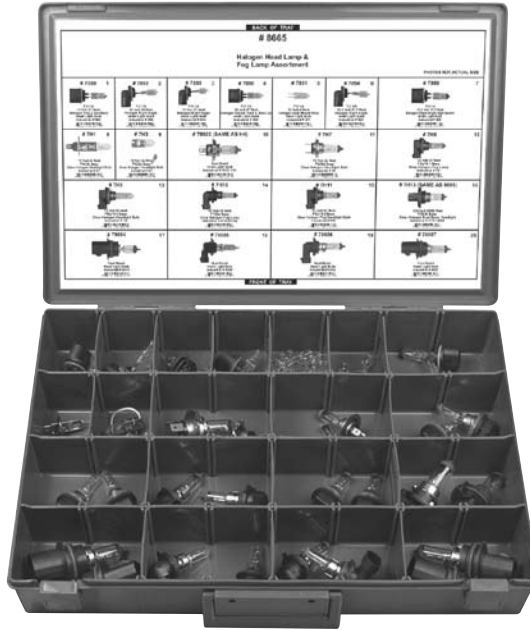

BACK OF TRAY

8665

Halogen Head Lamp & Fog Lamp Assortment

PHOTOS NOT ACTUAL SIZE

# 7880 1 T-3 1/4 12 Volt 27 Watt Halogen Fog & Auxiliary Head Light Bulb Industrial # 880 請於下列號碼後加註「工業」	# 7886 2 T-3 1/4 12 Volt 30 Watt Halogen Right Angle Head Light Bulb Industrial # 886 請於下列號碼後加註「工業」	# 7889 3 T-3 1/4 12 Volt 20 Watt Halogen Right Angle Head Light Bulb Industrial # 889 請於下列號碼後加註「工業」	# 7890 4 T-3 1/4 12 Volt 20 Watt Halogen Signal, Park & Back-up Head Light Bulb Industrial # 890 請於下列號碼後加註「工業」	# 7891 5 T-2 1/4 12 Volt 8 Watt Halogen High Mount Stop Head Light Bulb Industrial # 891 請於下列號碼後加註「工業」	# 7894 6 T-3 1/4 12 Volt 37.5 Watt Halogen Right Angle Head Light Bulb Industrial # 894 請於下列號碼後加註「工業」	# 7899 7 T-3 1/4 12 Volt 37.5 Watt Halogen Right Angle High Mount Head Light Bulb Industrial # 899 請於下列號碼後加註「工業」
# 7H1 8 12 Volt 55 Watt P14.54 Base Clear Halogen Headlight Bulb Industrial # H1 請於下列號碼後加註「工業」	# 7H3 9 12 Volt 55 Watt P22z Base Clear Halogen Headlight Bulb Industrial # H3 請於下列號碼後加註「工業」	# 79003 (SAME AS H4) 10 Dual Beam Head Light Bulb Industrial # 903 (H4) 請於下列號碼後加註「工業」		# 7H7 11 12 Volt 55 Watt Clear Halogen Headlight Bulb Industrial # H7 請於下列號碼後加註「工業」	# 7H8 12 12 Volt 35 Watt P42z Base Clear Halogen Fog Lamp Industrial # H8 請於下列號碼後加註「工業」	
# 7H9 13 12 Volt 65 Watt PG19-4 Base Clear Halogen Headlight Bulb Industrial # H9 請於下列號碼後加註「工業」	# 7H10 14 2 Volt 43 Watt P22z Base Clear Halogen Fog Lamp Industrial # H10 (P145) 請於下列號碼後加註「工業」	# 7H11 15 12 Volt 55 Watt PG19-2 Base Clear Halogen Fog/Headlight Bulb Industrial # H11 請於下列號碼後加註「工業」	# 7H13 (SAME AS 9008) 16 12 Volt 5555 Watt P26.4 Base Clear Halogen Dual Beam Headlight Industrial # H13 / 9008 請於下列號碼後加註「工業」			
# 79004 17 Dual Beam Head Light Bulb Industrial # 9004 請於下列號碼後加註「工業」	# 79005 18 Dual Beam Head Light Bulb Industrial # 9005 請於下列號碼後加註「工業」	# 79006 19 Dual Beam Head Light Bulb Industrial # 9006 請於下列號碼後加註「工業」	# 79007 20 Dual Beam Head Light Bulb Industrial # 9007 請於下列號碼後加註「工業」			

FRONT OF TRAY

8665 (Plastic Tray)

Shipped In an Adjustable Gray Plastic Tray

Covers High, Low & Fog Lights
Halogen Type
Contains 20 Different Sizes
39 Total Pcs.
Contains 49 Pcs.
Halogen Headlight Assortment
Sold Each

*Color Sales Brochures Available. Call for Details.



BACK OF TRAY

# 8667 Zinc Finish Cage Nut Assortment		
# 11005 Size: 10-24 Panel Range: :25-.063 Mounting Hole: 3/8	# 11006 Size: 10-24 Panel Range: :064-.105 Mounting Hole: 3/8	# 11007 Size: 10-32 Panel Range: :25-.063 Mounting Hole: 3/8
# 11008 Size: 10-32 Panel Range: :064-.105 Mounting Hole: 3/8	# 11009 Size: 1/4-20 Panel Range: :055-.063 Mounting Hole: 3/8	# 11011 Size: 5/16-18 Panel Range: :053-.125 Mounting Hole: 1/2
# 11010 Size: 1/4-20 Panel Range: :064-.105 Mounting Hole: 3/8	# 11013 Size: M5 x 8.8 Panel Range: 1.025-2.067 Mounting Hole: 3/8	# 11012 Size: 3/8-16 Panel Range: :053-.125 Mounting Hole: 1/2
# 11014 Size: M8 x 1 Panel Range: :025-1.40 Mounting Hole: 3/8	# 11015 Size: M6 x 1 Panel Range: 1.025-2.067 Mounting Hole: 3/8	# 11016 Size: 3/8-24 Panel Range: :057-.032 Mounting Hole: 1/2 Black Finish

FRONT OF TRAY

12

8667 (Plastic Tray)

Shipped In an Adjustable Gray Plastic Tray

Covers 10-24 to 3/8", 5mm & 6mm
Bright Zinc Finish
Contains 12 Different Sizes
505 Total Pcs.
Cage Nut Assortment
Sold Each

*Color Sales Brochures Available. Call for Details.



Disco #

7194	Industrial Bulb # 194	(10 per box)	Clear Miniature Light Bulbs
7194A	Industrial Bulb # 194A	(10 per box)	Amber Miniature Light Bulbs
7906	Industrial Bulb # 906	(10 per box)	Clear Miniature Light Bulbs
71156	Industrial Bulb # 1156	(10 per box)	Clear Miniature Light Bulbs
71157	Industrial Bulb # 1157	(10 per box)	Clear Miniature Light Bulbs
71157A	Industrial Bulb # 1157A	(10 per box)	Amber Miniature Light Bulbs
72057	Industrial Bulb # 2057	(10 per box)	Clear Miniature Light Bulbs
73057	Industrial Bulb # 3057	(10 per box)	Clear Miniature Light Bulbs
73156	Industrial Bulb # 3156	(10 per box)	Clear Miniature Light Bulbs
73157	Industrial Bulb # 3157	(10 per box)	Clear Miniature Light Bulbs
73157A	Industrial Bulb # 3157A	(10 per box)	Amber Miniature Light Bulbs
79004	Industrial Bulb # 9004	(1 per box)	Clear Miniature Light Bulbs
79007	Industrial Bulb # 9007	(1 per box)	Clear Miniature Light Bulbs

8700

Shipped In a 80321 Cabinet
 Wedge, Bayonet, & Headlight Bulbs
 Contains 13 Different Bulbs
 112 Total Pcs.
 Light Bulb Assortment
 Sold Each

NEW!

HOSE CLAMPS



- | | | | | | | | | | |
|--|---|---|--|---|---|---|---|---|---|
| 10889
#4 Mini
CR 14 - 3/8
Hose ID: 1.8-5/8 | 10890
#6 Mini
CR 5/16 - 7/8
Hose ID: 1/4-3/16 | 10891
#6 Clamp
CR 3/8 - 7/8
Hose ID: 5/16-3/8 | 10893
#10 Clamp
CR 1/2 - 1 1/16
Hose ID: 3/8-5/8 | 10894
#12 Clamp
CR 1/2 - 1 1/4
Hose ID: 3/8-3/4 | 10895
#16 Clamp
CR 11/16 - 1 1/2
Hose ID: 3/4-7/8 | 10896
#20 Clamp
CR 3/4 - 1 3/4
Hose ID: 3/4 - 1 1/8 | 10898
#28 Clamp
CR 1 1/4 - 2 1/2
Hose ID: 1 1/4 - 1 5/8 | 10899
#32 Clamp
CR 1 1/2 - 2 1/2
Hose ID: 1 5/8 - 1 7/8 | 10900
#36 Clamp
CR 1 3/4 - 2 3/4
Hose ID: 1 3/4 - 2 |
|--|---|---|--|---|---|---|---|---|---|

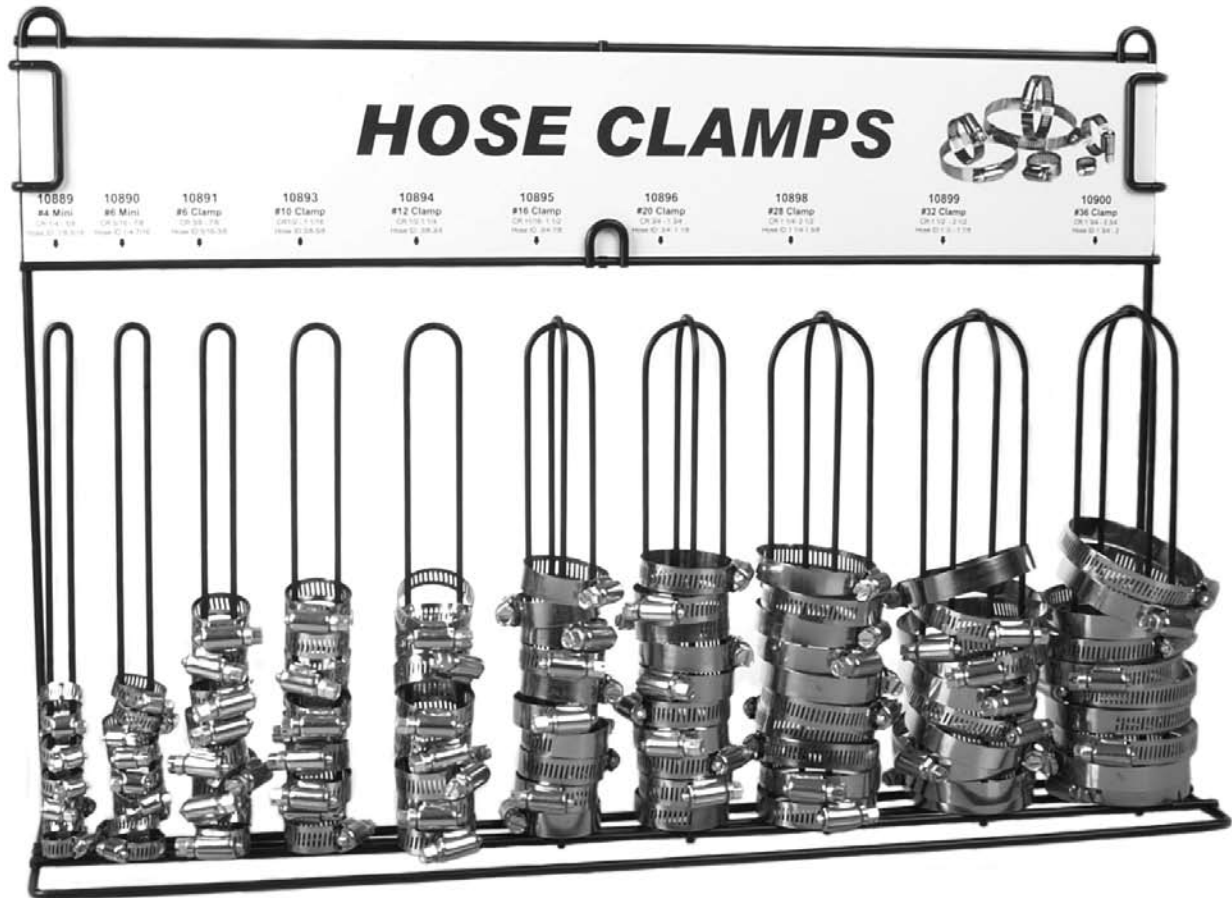

8701

Stainless Steel Band and Housing
#4 to #36 Clamp Sizes
Contains 10 Different Sizes
100 Total Pcs.
Hose Clamp Assortment
Sold Each

*Color Sales Brochures Available. Call for Details.

NEW!



Shelves Not Included



8050

**Top Selling 200 Items
750 Total Bags
Includes Catalogs, Posters &
Labeled Storage Bin Boxes
Sold Each**

Introducing the **8050 Disco Starter Kit**. A great system for PBE or Warehouse Suppliers.

What you will receive is the Top 200 most popular body shop items. Ready to sell in packaged bags with photos and description on each bag.

This will contain the most popular 100 items with 5 bags of each. The next, most popular 50 items with 3 bags of each. Followed by the remaining 50 items with 2 bags of each.

We also supply 200 bin boxes labeled with photos, quantity and description for you.

Also will include, wall charts, catalogs, pricing, & planographs on how to setup and lots more.

No guessing on what to order and how to stock. The #8050 starter system comes with everything you need to get you selling A.S.A.P.

***Color Sales Brochures Available. Call for Details.**

The image features a variety of service equipment scattered around the central text. On the left, there are three toolboxes: a small one at the top, a medium one in the middle, and a large one at the bottom. In the center, there is a small, open, light-colored storage bin. To the right, there is a large, open metal cabinet with three shelves. Below the central text, there is a wire rack with several vertical slots. At the bottom right, there is a large, open, multi-compartment storage bin. The background is plain white.

Service Equipment

80006



6 3/4" x 11" x 1 3/4"
6 Compartments
Polypropylene Plastic
Transparent Boxes
Sold Each

80119



6 3/4" x 11" x 1 3/4"
18 Compartments
Polypropylene Plastic
Transparent Boxes
Sold Each

80106



6 3/4" x 11" x 1 3/4"
6 Compartments
Polypropylene Plastic
Transparent Boxes
Sold Each

80110



6 3/4" x 11" x 1 3/4"
10 Compartments
Polypropylene Plastic
Transparent Boxes
Sold Each



80112



6 3/4" x 11" x 1 3/4"
12 Compartments
Polypropylene Plastic
Transparent Boxes
Sold Each

80118



6 3/4" x 11" x 1 3/4"
18 Compartments
Polypropylene Plastic
Transparent Boxes
Sold Each

80352



10 3/4"H x 11 1/4"W x 6 3/4"D
Gray Finish
Small Metal Gray Cabinet
Holds Up To 5 Trays
Use with 80106, 80112, 80118 & 80119
Sold Each

80120



GRAY
21 Hole with Latches
3 1/8"H x 18 1/4"W x 12 1/4"D
Large Right Hole for Tool Storage
Large Plastic Tray
Use with 80320
Sold Each

80123



GRAY
24 Hole with Latches
3 1/8" High
18 1/4" Wide 12 1/4" Deep
Large Plastic Tray
Use with 80320
Sold Each

80123GC



GRAY WITH CLEAR LID
24 Hole with Latches
3 1/8" High
18 1/4" Wide 12 1/4" Deep
Large Plastic Tray
Use with 80320
Sold Each

80123B



BLUE
24 Hole with Latches
3 1/8" High
18 1/4" Wide 12 1/4" Deep
Large Plastic Tray
Use with 80320
Sold Each

80123R



RED
24 Hole with Latches
3 1/8" High
18 1/4" Wide 12 1/4" Deep
Large Plastic Tray
Use with 80320
Sold Each

80123YC



YELLOW WITH CLEAR LID
24 Hole with Latches
3 1/8" High
18 1/4" Wide 12 1/4" Deep
Large Plastic Tray
Use with 80320
Sold Each

80122



GRAY
24 Hole without Lid and Latches
3 1/8" High
18 1/4" Wide 12 1/4" Deep
Large Plastic Tray
Use with 80320
Sold Each

80132GC



GRAY CLEAR LID
32 Hole with Latches
3 1/8" High
18 1/4" Wide 12 1/4" Deep
Large Plastic Tray
Use with 80320
Sold Each

80132YC



YELLOW WITH CLEAR LID
32 Hole with Latches
3 1/8" High
18 1/4" Wide 12 1/4" Deep
Large Plastic Tray
Use with 80320
Sold Each

80132



GRAY
32 Hole Adjustable with Latches
3 1/8"H x 18 1/4"W x 12 1/4"D
Large Plastic Tray
Use with 80320
Sold Each

80323



GRAY
24 Hole with Latches
3 1/8" High
18 1/4" Wide 12 1/4" Deep
Large Metal Tray
Use with 80320
Sold Each

80133



GRAY
2 3/4" x 2 1/2"
(7 Dividers Per Set)
Dividers
Use with 80132, 80132GC
1 Set

80121



Gray Nylon
Cover, Screws, Nuts & Handle
for Large Style Plastic Trays
Sold Each

80320



GRAY
14 3/4"H x 20 1/4"W x 12 3/4"D
Large Metal Slider
Use with 80123 or 80323
Sold Each

80354



GRAY
Metal Slider Stand
Use with 80320
Sold Each

13

80321

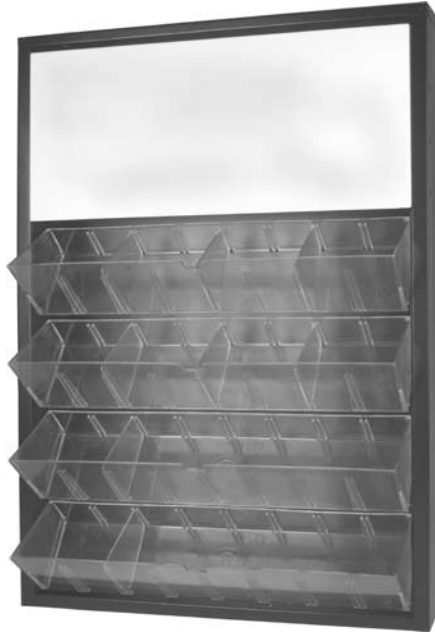

26 3/4" H x 19" W x 4" D
Adjustable Dividers per Tray
22 Ga. Steel Frame
Black Baked Enamel
Storage Cabinet
Sold Each

80341



40 Hole
35 1/4" Wide x 11 7/8" Deep x 21" High
Gray Finish
Compartment Bin
Sold Each

Metal Bolt Bin Stand



80353 (12" Legs)

80356 (4" Legs)

12" x 35 1/2" Base
 Gray Finish
 Use with 80341
 Sold Each

Corrugated Bin Box

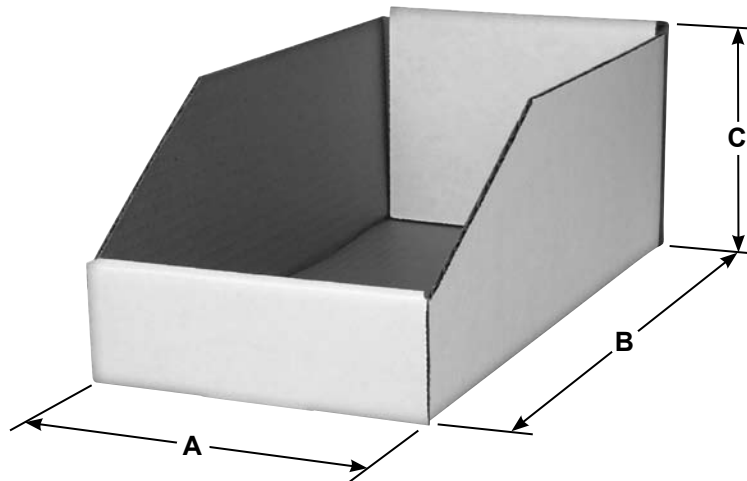

Part Number	Dimension	Dimension	Dimension	Pkg Qty
	A	B	C	
10704	2"	12"	4 1/2"	Sold Each
10705	4"	12"	4 1/2"	Sold Each
10706	6"	12"	4 1/2"	Sold Each
10707	8"	12"	4 1/2"	Sold Each
10708	10"	12"	4 1/2"	Sold Each
10709	12"	12"	4 1/2"	Sold Each

80134

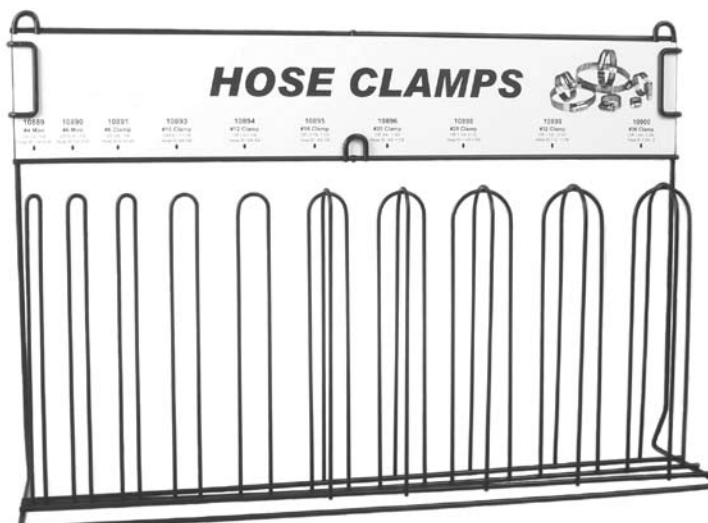

**For Clamp Sizes 4 - 36
Will stand on a table or
can be mounted to a wall
Black Finish
Hose Clamp Rack
Sold Each**

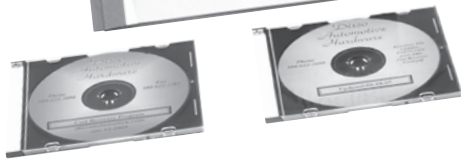

Sales Aids

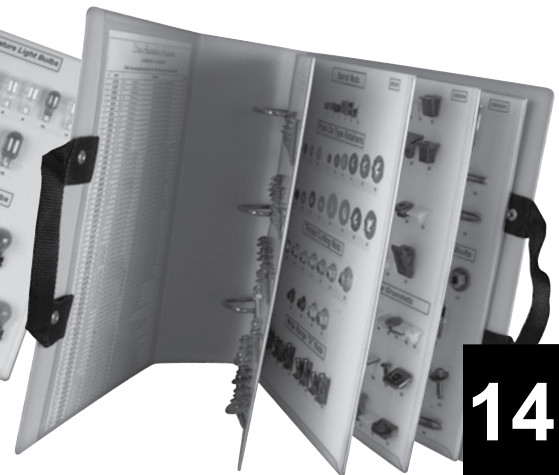

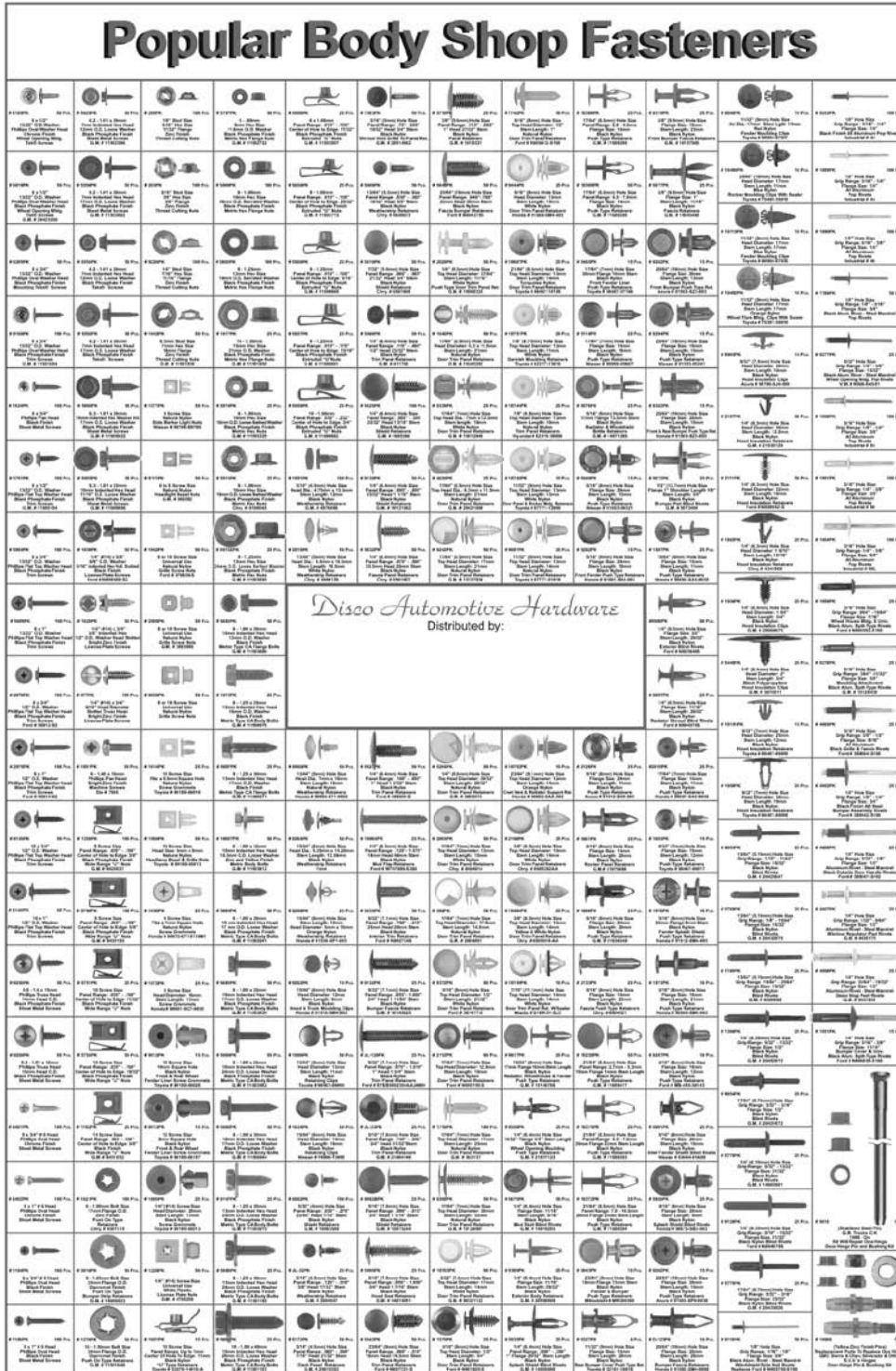

English Wall Poster

1 EP
 26" x 39" English Wall Poster
 Covers Top Selling Body Shop Fasteners
 Contains 209 Different Items
 Sold Each

Sujetadores Populares para Taller de Enderezado

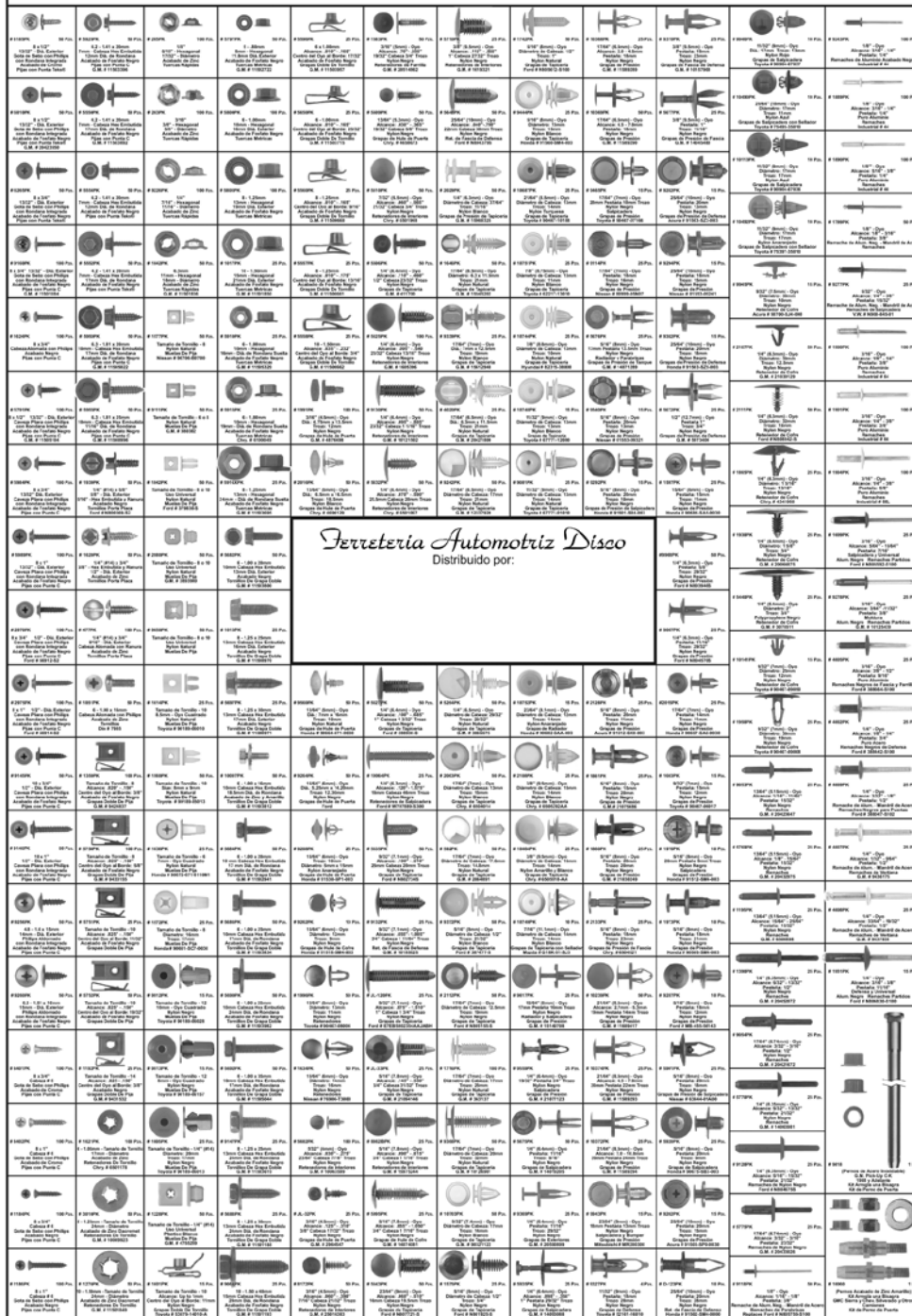

Spanish Wall Poster

1 SP
 26" x 39" Spanish Wall Poster
 Covers Top Selling Body Shop Fasteners
 Contains 209 Different Items
 Sold Each

Cost Recovery Program

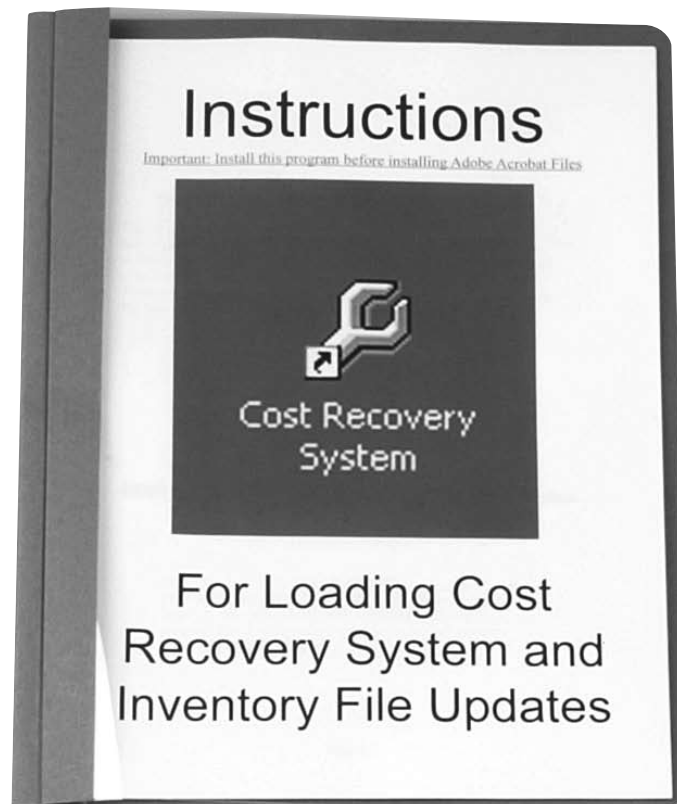

Disco's Cost Recovery System (Sold through Distributors Only) quickly and easily creates invoices for fasteners used in daily body shop repair. Once created, the invoice is submitted to the insurance company for reimbursement.

A "Quick Reference Form" that saves time in identifying and recording fastener part numbers is included. The system's "Price List" contains part number, description and price of each item and can be changed and/or added to as needed. Prices listed in this program are what Disco considers to be O.E.M. original Price.

- 9930** Complete Cost Recovery Program (Shown Above)
- 9931** Name Stamp (This adds name and address to the Program)
- 9932** Update Disk (Updates the Parts List within the Program)

Part#	Description	Price	Markup %	Selling Price
1000	Black Phos. Hex Loose Washer Body Bolts	0.99	0	0.990000
1001	Black Phos. Hex LWasher Body Bolts	1.16	0	1.160000
1003	Headlamp Adjusting Nut & Screws	1.78	0	1.780000
10052	Zinc Finish Sheet Metal Screws	0.13	0	0.130000
10056	White Nylon Rocker Panel Mldg. Clip	0.84	0	0.840000
10060	Door Hinge Pin & Bushing Kit	74.75	0	74.750000
10061	Door Hinge Pin	35.20	0	35.200000
10062	Door Hinge Pin	35.20	0	35.200000
10064	Black Nylon Mud Flap Retainers	1.01	0	1.010000
101	Zinc Plated Machine Screw Hex Nuts	0.07	0	0.070000
1013	Black Phos. Hex Flange Hd Body Bolts	0.67	0	0.670000
1017	Black Finish Hex Flange Nuts	0.46	0	0.460000
1019	Headlight Adjusting Nut & Screws	0.95	0	0.950000
1024	Natural Nylon Door Trim Panel Ret.	0.41	0	0.410000
1026	Moulding Clips	0.49	0	0.490000
1041	Black Finish Hex Thread Cutting Nuts	0.17	0	0.170000

Price List

TFW Supplemental Invoice Program

Easy Invoice Entry

RO#

Part#

Qty

Price

Next Done Previous Delete Cancel

Record # 1 of 1

Order Entry

R.O. Number: _____ **Technician:** _____

	6185 Chrome Phillips Oval Washer Trim Screws 8 41213 400727 117	
	6265 Black Phos. Phillips Oval Washer Trim Screws 8 41213 400729 11	
	6411 Chrome Plated Sheet Metal Screws 8 41213 400745 11	
	5989 Black Phos. Phillips Flat Top Trim Screws 8 41213 400711 16	
	5550 Black Phos. Hex Loose Washer Trim Screws 8 41213 400711 16	

Quick Reference
Cost Recovery Form

Test Automotive Fasteners
123 Test St
Sulphur, OK 73086

Invoice# 1011 Date: 01/11/2007

RO# 101	Sold To Repair Center:
Make/Model: G.M. Car	Nevada Auto Collision Center
Customer: John Doe	1636 S Mojave Rd
Address: 123 Hill Lane	Las Vegas, NV 89104
City/State/Zip: Sulphur, OK 73086	Phone/fax: 702-457-2008 /

Ref. No	Quantity	Description	Price	Extended
5284	10	Natural Nylon Door Trim Panel Clips	0.43	4.30
1860	10	Black Nylon Push Type Retainers	1.35	13.50
4007	5	Alum.Steel Window Reg. Peel Rivets	1.16	5.80
3602	5	Yellow Nylon Butt Connectors	0.55	2.75
1704	2	Black Nylon Cable Ties	0.50	1.00
Total				27.35

Prepared Invoice for
Insurance Company

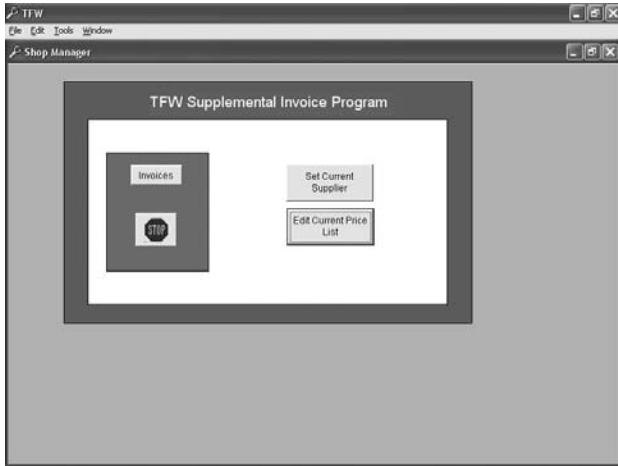

Opening Screen

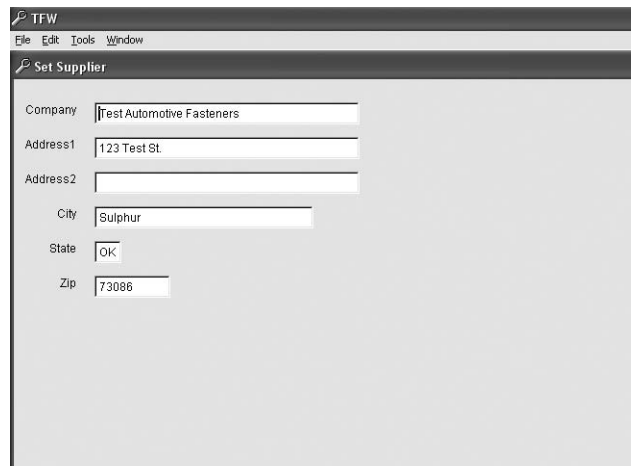

Set Current Supplier

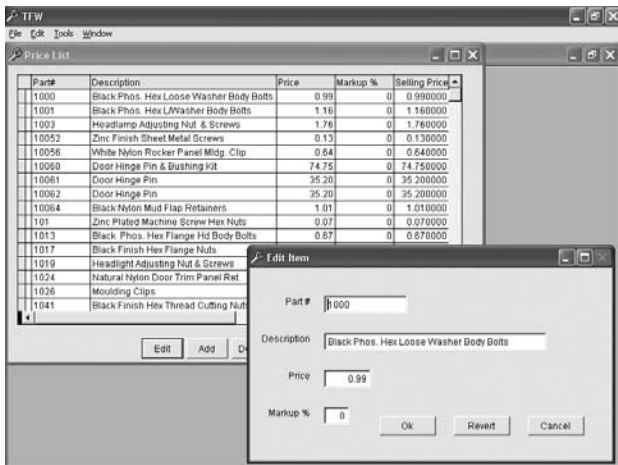

Edit Current Price List
Edit Mode

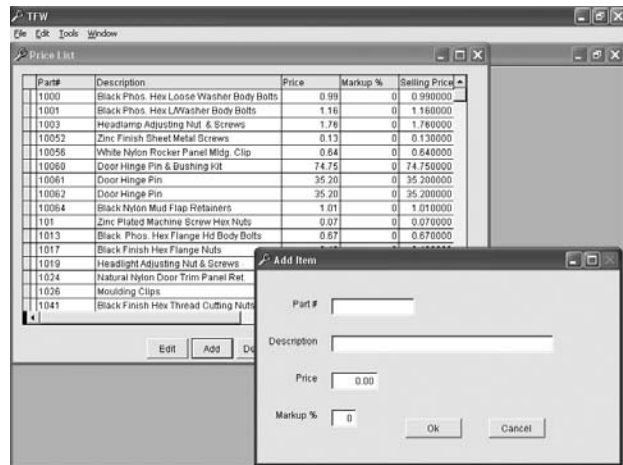

Edit Current Price List
Add Mode

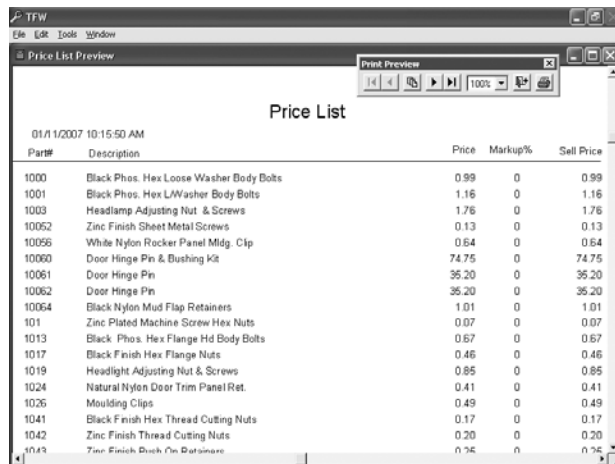

Edit Current Price List
Print Mode



Easy Data Entry Screen

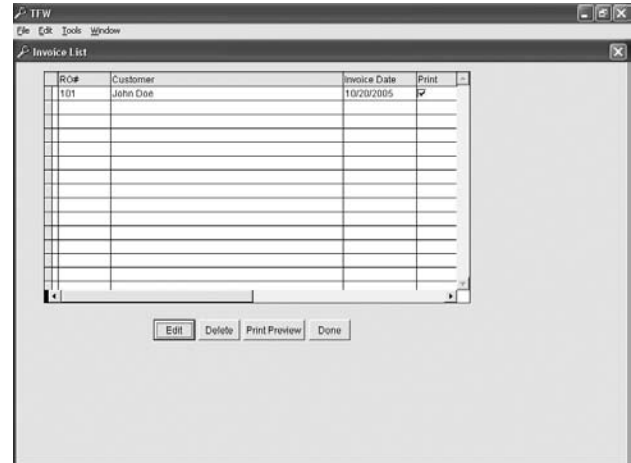

Invoice Preparation Screen

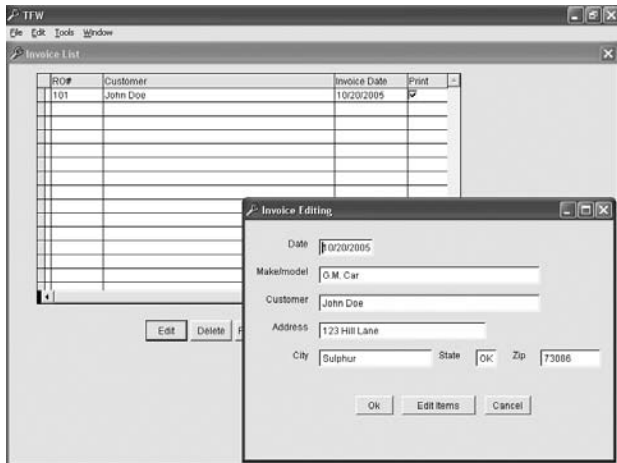

Invoice Preparation Screen
Edit Mode

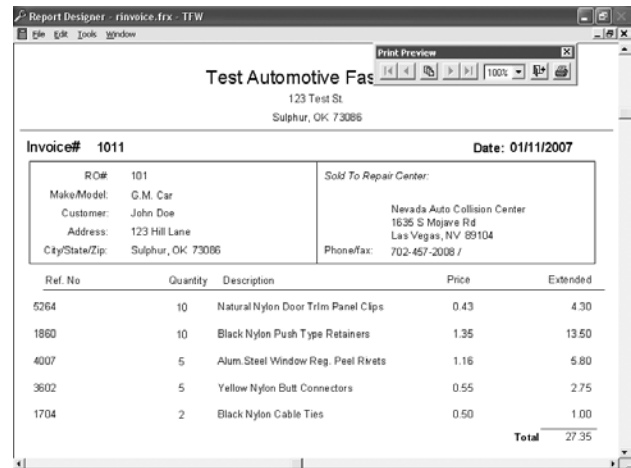

Invoice Preparation Screen
Print Preview Mode

Christmas Tree Merchandiser

Largest Coverage For Top Body Shop Fasteners



Front
of Box
shows a
picture
and size

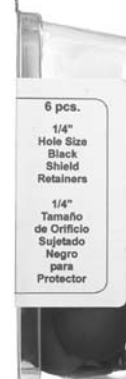

Side of
Box shows
quantity
and has a
description
in English
& Spanish

- ✓ Over 380 Different Items
- ✓ Over 1570 Packaged Items
- ✓ The Most Complete Selection of Body Shop Fasteners in the Industry
- ✓ Coverage for models like:
Accura, Chrysler, Ford, GM, Honda,
Isuzu, Lexus, Mazda, Mitsubishi,
Nissan and Toyota

#8000 Assortment of Boxes for Tree (Tree stand sold separately)

#8002 Assortment of Boxes for Tree (Tree stand sold separately)

#8001 Tree Stand Only

(For more information please call)

Merchandiser Features

1. Extra Heavy, Double Wire Gauge Hooks for additional weight (Body Bolts)
2. Written in English and Spanish
3. Nearly 400 Items - 1600 Packages
4. Large Selection
5. Most Popular Items
6. Exchange Privileges (First 6 Months)
7. Reorder Tags are Numbered for positions
Much easier to setup and restock
Sides: #1 - #2 - #3 - #4
Hook Numbers: Example

	Side	Hook
	2	10
8. Large Swivel Base and Balanced Stand
9. Good Description on Every Box
10. All the Same Price - You Don't have to Look Up Numbers to Price
11. Easy to Reorder
12. Each Box Color Coded for Easy Set Up and Restocking
13. Sturdy Plastic Clam Shell Box
14. Exact Drawing on Each Label
15. Good Profit Margins Built into Pricing
16. Minimal Floor Space Required
17. Future Expansion and Customizing Planned
18. Prompt Delivery
19. Covers Early and Late Model Vehicles
20. Includes Domestic and Foreign Cars and Trucks

Sample Boards



Binder and Sample Boards Sold Separately

Your Name and Logo

Your Part Number

Disco Automotive Hardware

Your PK Quantity

P.O. Box 858 Sulphur Ok. 73086

#	Part Number	Description		Pkg Qty
1	6399	8 x 3/8"	#6 Head Phillips Oval Head Chrome Finish Sheet Metal Screws Undersized Head	100
2	6400	8 x 1/2"	#6 Head Phillips Oval Head Chrome Finish Sheet Metal Screws Undersized Head	100
3	6401	8 x 3/4"	#6 Head Phillips Oval Head Chrome Finish Sheet Metal Screws Undersized Head	100
4	6402	8 x 1"	#6 Head Phillips Oval Head Chrome Finish Sheet Metal Screws Undersized Head	100

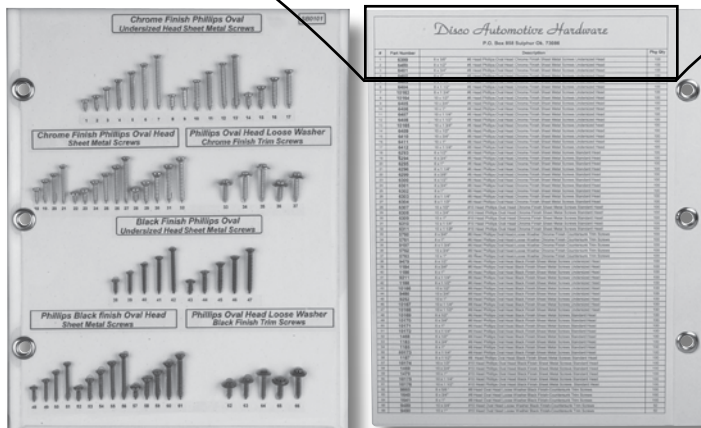

2 Sided Sample Boards
With Technical Information for Every Part



SBB
14.5" High x 13" Wide, 5" Spine
2.5" Square 3 Ring Binder
Beige Poly Sample Board Binder
Sold Each

Sample Boards Are Updated Frequently. They May Not Match Photo.

SB0101

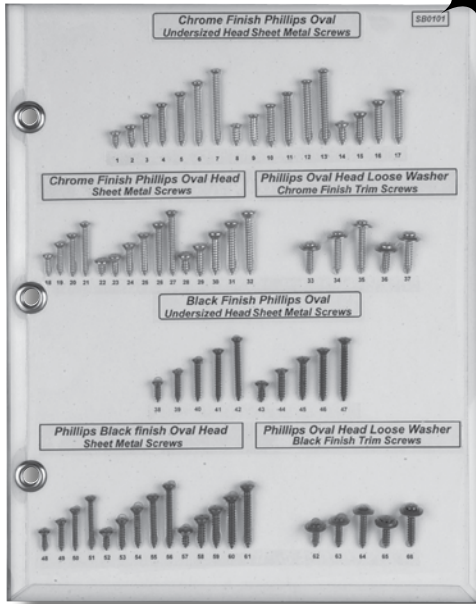

Phillips Oval Head
Standard & Undersized Head
Chrome & Black Finish
Sheet Metal Screws
Sold Each

Sample Boards Are Updated Frequently. They May Not Match Photo.

SB0103



Phillips & Hex Head
Automotive Type
Sheet Metal Screw
Sample Board
Sold Each

Sample Boards Are Updated Frequently. They May Not Match Photo.

SB0201

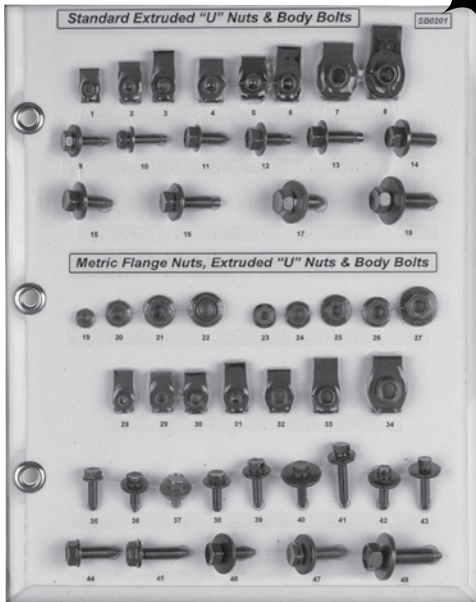

Black & Yellow Zinc Finish
Standard Extruded "U" Nuts
Hex Flange & Loose Washer Body Bolts
Metric Flange Nuts, Extruded "U" Nuts
Hex Flange & Loose Washer Body Bolts
Sold Each

Sample Boards Are Updated Frequently. They May Not Match Photo.

SB0301

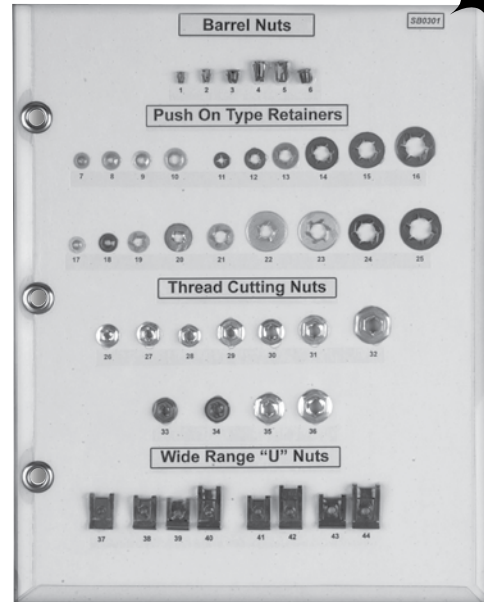

Barrel, Flat, "U" Type &
Thread Cutting
Automotive Type Nut
Sample Board
Sold Each

Sample Boards Are Updated Frequently. They May Not Match Photo.

SB0304

NEW!

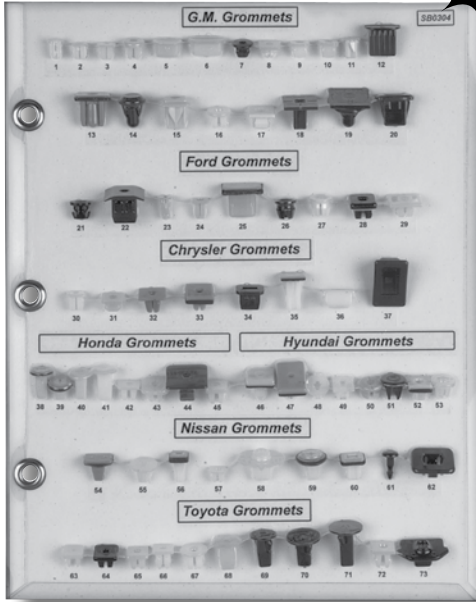

Multiple Colors Coded To O.E.M.
Nylon Grommets
G.M., Ford, Chrysler
Honda, Nissan & Toyota
Sold Each

Sample Boards Are Updated Frequently. They May Not Match Photo.

SB0401

NEW!



Black, Clear, Grey, White,
Natural & Blue
Universal Use For All Cars & Trucks
Nylon Shield Retainers
Sold Each

Sample Boards Are Updated Frequently. They May Not Match Photo.

SB0402

NEW!



Black Nylon
Screw & Push Type Retainers
G.M. Model Cars & Trucks
Sold Each

Sample Boards Are Updated Frequently. They May Not Match Photo.

SB0403

NEW!

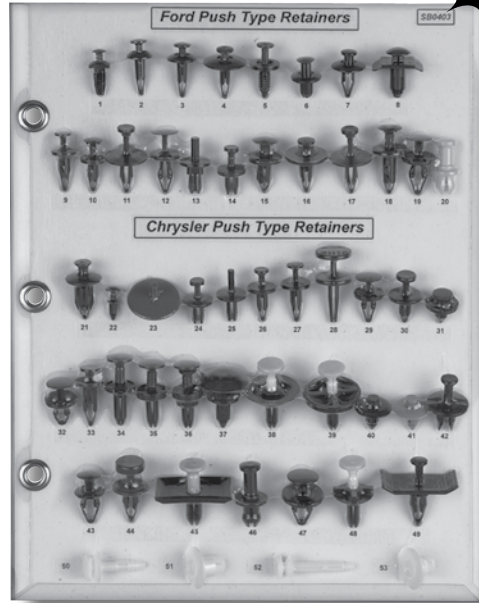

Black, White & Natural Nylon
Screw & Push Type Retainers
Ford & Chrysler Model Cars & Trucks
Sold Each

Sample Boards Are Updated Frequently. They May Not Match Photo.

SB0404

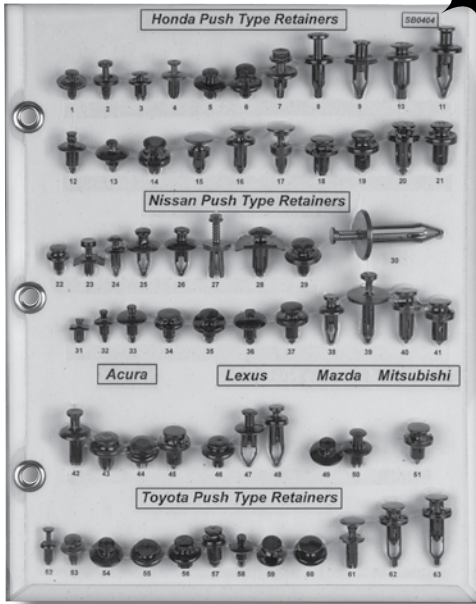

**Black Nylon
Screw & Push Type Retainers
Honda, Nissan, Toyota,
Acura, Lexus, Mazda & Mitsubishi
Model Cars & Trucks
Sold Each**

Sample Boards Are Updated Frequently. They May Not Match Photo.

SB0405

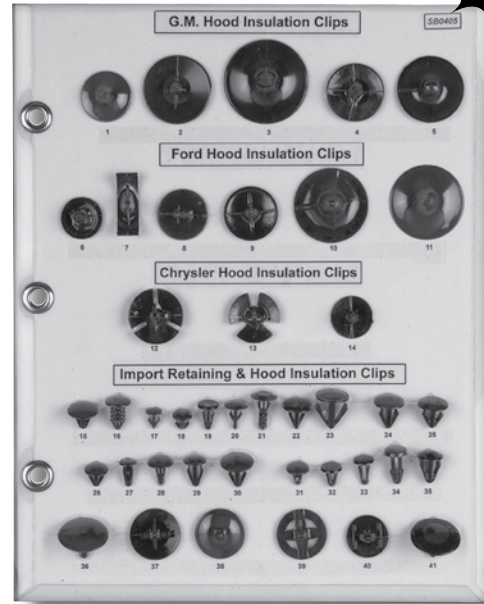

**Black Nylon
Various Domestic & Import
Retaining & Hood Clip
Sample Board
Sold Each**

Sample Boards Are Updated Frequently. They May Not Match Photo.

SB0601

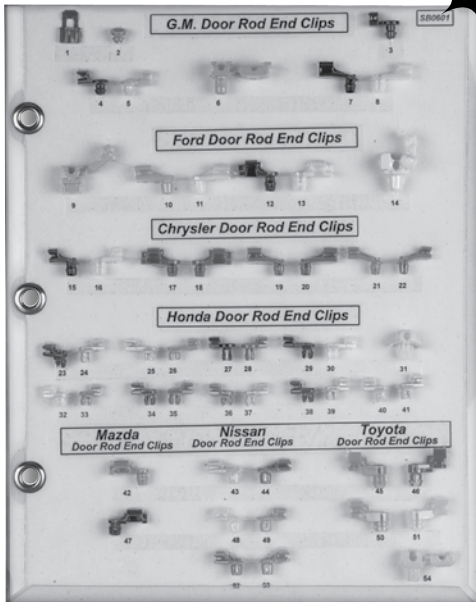

**Multiple Colors Coded To O.E.M.
Nylon Door Rod End Clips
G.M., Ford, Chrysler,
Honda, Mazda, Nissan & Toyota
Sold Each**

Sample Boards Are Updated Frequently. They May Not Match Photo.

SB0602

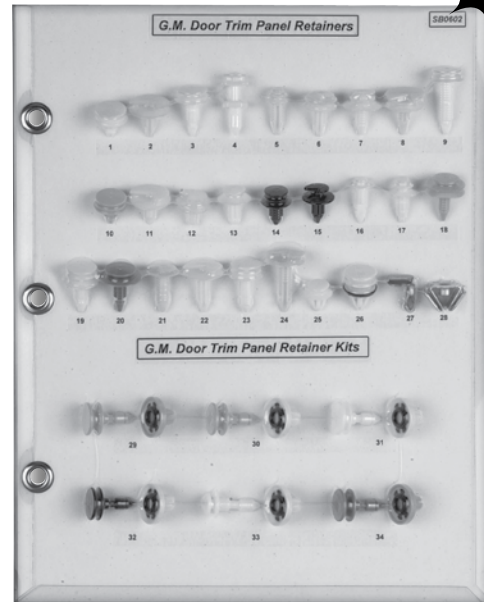

**Zinc Finish Metal & Nylon
Multiple Colors Coded To O.E.M.
G.M. Door Trim Panel Retainers & Grommets
Sold Each**

Sample Boards Are Updated Frequently. They May Not Match Photo.

SB0603

NEW!

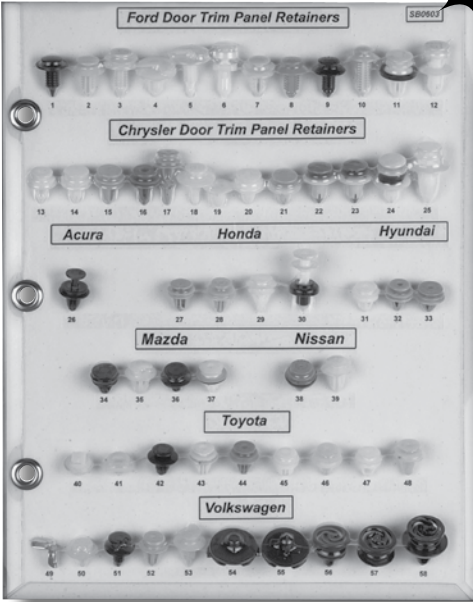

Multiple Colors Coded To O.E.M.
Nylon Door Trim Panel Retainers
Ford, Chrysler, Honda, Mazda,
Nissan & Toyota
Sold Each

Sample Boards Are Updated Frequently. They May Not Match Photo.

SB0801

NEW!

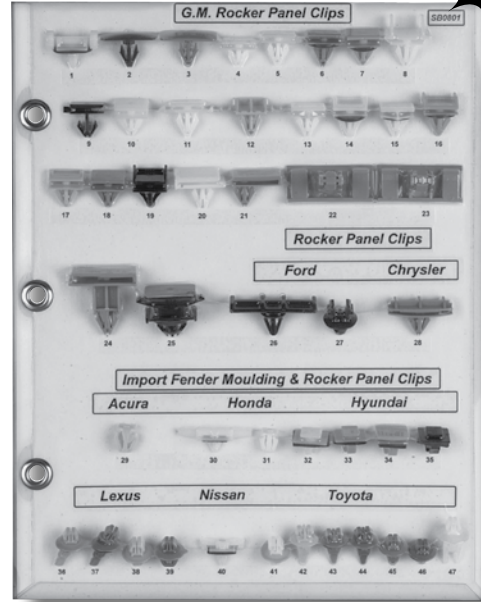

Multiple Colors Coded To O.E.M.
Nylon Fender Moulding &
Rocker Panel Moulding Clips
G.M., Ford, Chrysler,
Acura, Honda, Lexus, Suzuki & Toyota
Sold Each

Sample Boards Are Updated Frequently. They May Not Match Photo.

SB0802

NEW!



4 & # 6 through # 36
Steel Hex Slotted Screw
Stainless Steel Band & Housing
Hose Clamps Sample Board
Sold Each

Sample Boards Are Updated Frequently. They May Not Match Photo.

SB0902

NEW!



All Aluminum Blind Rivets
Dome & Large Flange
3/32", 1/8", 5/32", 3/16",
& 1/4" Diameters
Sold Each

Sample Boards Are Updated Frequently. They May Not Match Photo.

SB0903

NEW!

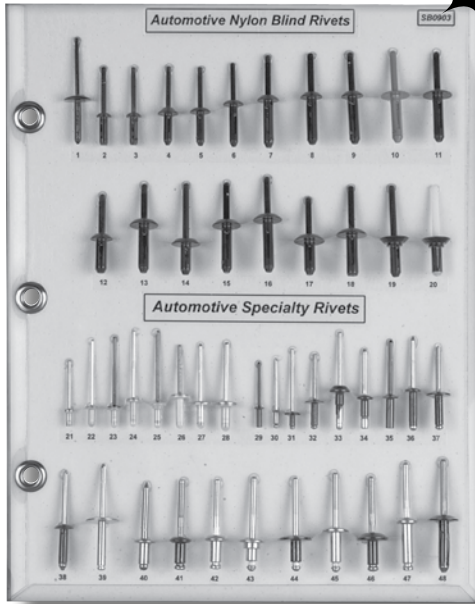

**Black Nylon, Aluminum & Steel
Automotive Blind Rivets
G.M., Ford & Chrysler
Sold Each**

Sample Boards Are Updated Frequently. They May Not Match Photo.

SB1001

NEW!

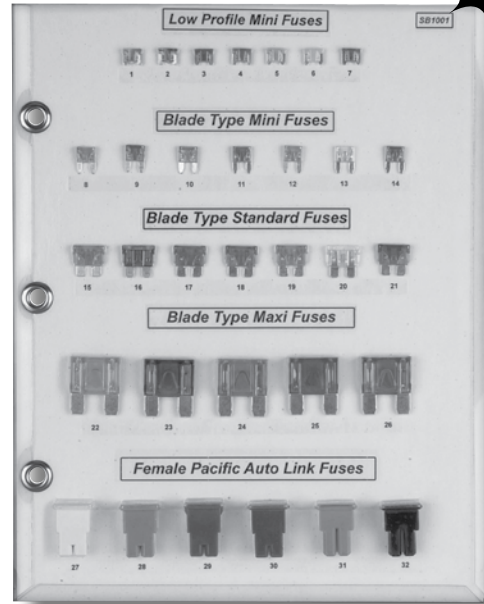

**Multiple Color Fuses
Color Coded To Amperage
ATM (Mini), ATO (Standard),
ATX (Maxi) &
Female PAL (Pacific Auto Link)
Sold Each**

Sample Boards Are Updated Frequently. They May Not Match Photo.

SB1002

NEW!

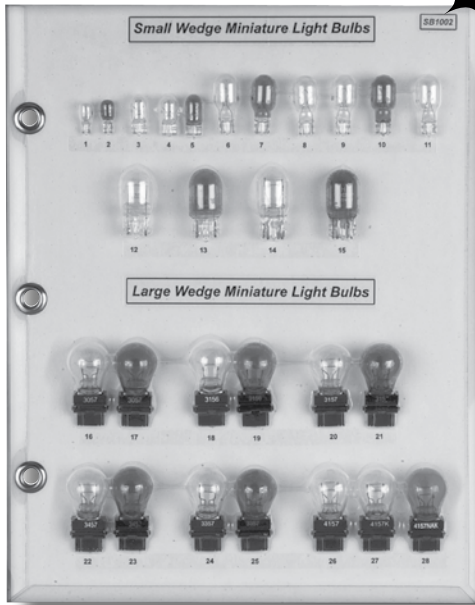

**Clear & Amber
Small & Large Wedge
Miniature Light Bulbs
Sold Each**

Sample Boards Are Updated Frequently. They May Not Match Photo.

SB1003

NEW!



**Clear & Amber
Bayonet & Dome Type
Miniature Light Bulbs
Sold Each**

SB1004

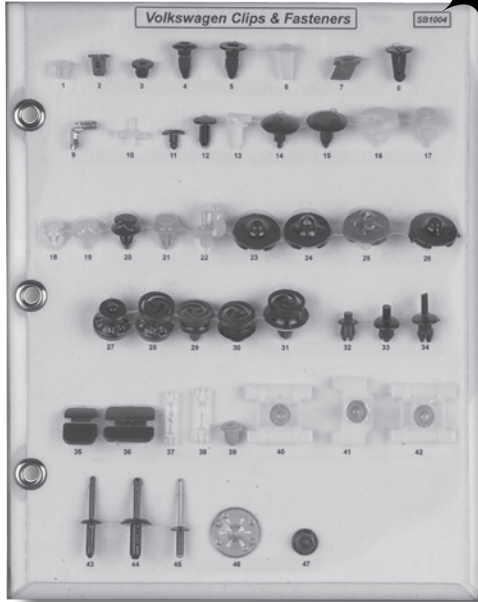

Sample Boards Are Updated Frequently. They May Not Match Photo.

**Various Clips and Fasteners
All Volkswagen
Sold Each**

Lid Label Display Binders

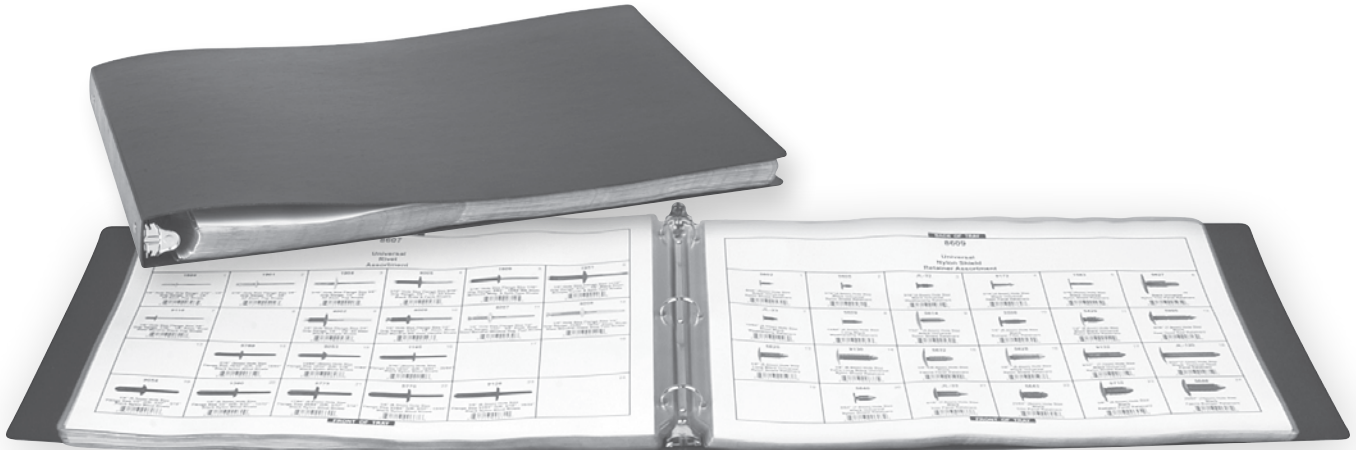

Your Name and Logo

Your Part Number

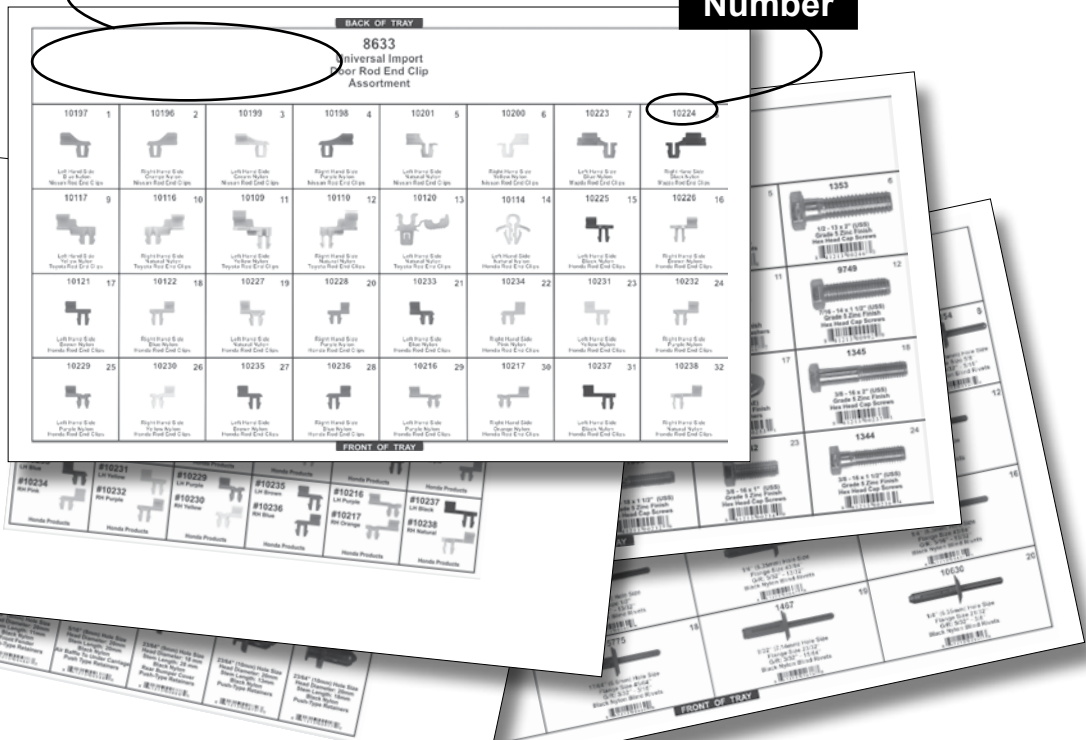

#10698

Contains Lid Label Information
Covering Large & Small Assortments
11" x 17" Black Poly
Lid Label Display Binder

Sold Each

#10696

Display Binder Only

Sold Each

#10697

11" x 17" Vinyl Sheet Protector

Sold Each

Body Shop Bin Labels



#10792

Body Shop Bin Labels
Covering 375 of the Most Popular Products
2 1/2" x 1 3/4" Label Size
Self Adhesive
Body Shop Bin Labels
1 Set

14

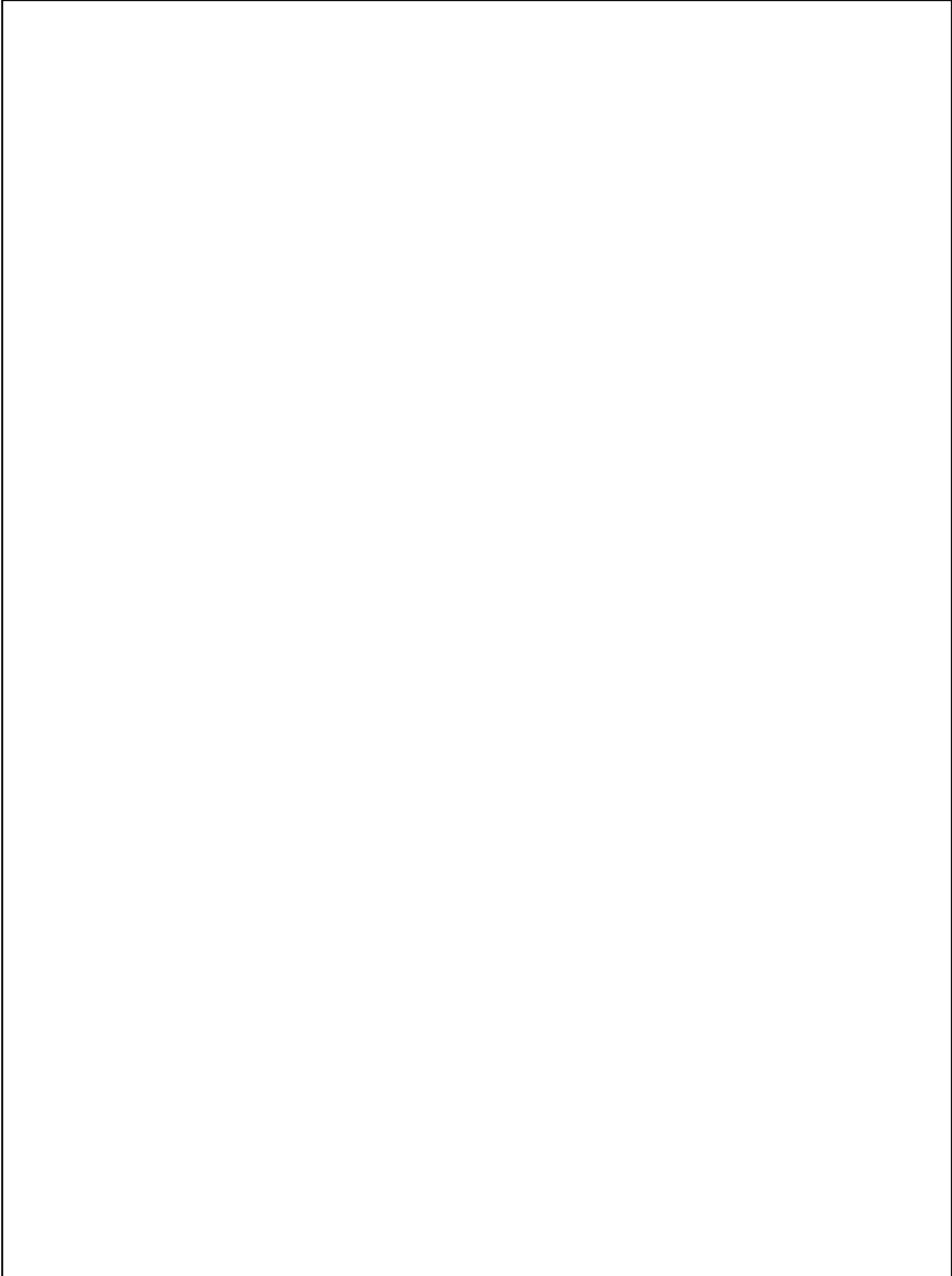

O.E.M. Crossover

O.E.M. #	Make	Disco#	Page#	O.E.M. #	Make	Disco#	Page#
45267	Ford	5480PK	51	3960314	G.M.	210PK	24
45269	Ford	5466PK	52	3986997	G.M.	1000PK	25
152273	G.M.	938PK	51	3997391	G.M.	1997PK	58
330485	G.M.	9221PK	68	4005099	AMC	9373PK	144
332364	G.M.	5429PK	76	4033711	Chrysler	1269PK	160
343543	G.M.	972PK	172	4081765	G.M.	9881PK	194
343543	G.M.	996PK	172	4114785	G.M.	9900PK	139
358470	Ford	578PK	139	4234830	G.M.	1083PK	130
358560	Ford	9879PK	193	4339372	Chrysler	1570PK	159
363137	G.M.	1716PK	143	4341060	Chrysler	1865PK	86
365270	G.M.	1019PK	172	4533699	G.M.	816PK	124
367291	G.M.	9541PK	29	4630088	Chrysler	10563PK	205
367292	G.M.	9371PK	30	4630253	Chrysler	2050PK	113
380370	G.M.	9872PK	65	4630660	Chrysler	10564PK	205
380382	G.M.	9111PK	55	4658444	Chrysler	9961PK	132
386285	Ford	10243PK	69	4658445	Chrysler	9384PK	132
407217	G.M.	1001PK	25	4658673	Chrysler	5609PK	74
411700	G.M.	5506PK	76	4658674	Chrysler	9962PK	132
472434	G.M.	1087PK	99	4658675	Chrysler	9963PK	132
528846	G.M.	1095PK	31	4696129	Chrysler	2016PK	90
556196	G.M.	1003PK	172	04696963	Chrysler	10676PK	75
1150522	G.M.	5950PK	15	4717164	Chrysler	9986PK	129
1254815	G.M.	9085PK	55	4717165	Chrysler	9987PK	128
1355003	G.M.	9873PK	57	4755299	G.M.	1228PK	66
1370853	G.M.	1297PK	55	4759145	G.M.	308PK	192
1377030	G.M.	637PK	57	4876498	G.M.	1991PK	89
1494252	G.M.	2969PK	51	4879431	G.M.	552PK	2
1494253	G.M.	1835PK	52	5240734	Chrysler	10245PK	69
1494254	G.M.	5412PK	52	5480772	G.M.	10535PK	113
1494258	G.M.	1836PK	52	5480852	G.M.	10485PK	182
1605396	G.M.	5625PK	77	5973400	G.M.	5672PK	112
1606642	G.M.	853PK	173	5973823	G.M.	1234PK	112
1619321	G.M.	5710PK	83	6000558	Chrysler	711PK	44
1624705	Chrysler	347PK	193	6000705	Chrysler	345PK	193
1644290	G.M.	9528PK	73	6000943	Chrysler	9113PK	58
1654047	G.M.	986PK	125	6003752	Chrysler	9504PK	126
1688094	G.M.	1026PK	178	6025329	Chrysler	9417PK	24
1689827	G.M.	5765PK	6	6026723	Chrysler	855PK	28
2048248	G.M.	1644PK	79	6028993	Chrysler	1292PK	165
2064891	G.M.	592PK	141	6034608	Chrysler	9414PK	75
2964547	G.M.	JL-32PK	72	6035401	Chrysler	10548PK	60
3065575	G.M.	5264PK	141	6035821	Chrysler	10553PK	59
3078511	G.M.	5440PK	86	6100049	Chrysler	5915PK	48
3454220	Chrysler	1249PK	132	6100050	Chrysler	10838PK	48
3454221	Chrysler	1250PK	132	6100539	Chrysler	10970PK	25
3540858	G.M.	9745PK	99	6270163	G.M.	1761PK	76
3574085	Chrysler	681PK	172	6271989	G.M.	1288PK	163
3744999	G.M.	344PK	193	6500898	Chrysler	1195PK	202
3759944	Chrysler	10652PK	73	6501067	Chrysler	5632PK	78
3893980	G.M.	2980PK	59	6501178	Chrysler	1621PK	42
3919773	G.M.	1574PK	59	6501925	Chrysler	2045PK	98
3921446	G.M.	656PK	172	6501948	Chrysler	5610PK	74

O.E.M. Crossover

O.E.M. #	Make	Disco#	Page#	O.E.M. #	Make	Disco#	Page#
6502104	Chrysler	5628PK	78	10125439	G.M.	9278PK	207
6502689	Chrysler	5768PK	202	10126901	G.M.	9368PK	144
6502991	Chrysler	9379PK	146	10140480	G.M.	1730PK	120
6503106	Chrysler	10505PK	99	10153057	G.M.	1807PK	143
6503204	Chrysler	9380PK	146	10157900	G.M.	9370PK	109
6503336	Chrysler	2077PK	121	10169777	G.M.	5605PK	72
6503339	Chrysler	2076PK	121	10185925	G.M.	9132PK	80
6503819	Chrysler	10539PK	84	10242298	G.M.	9992PK	182
6504014	Chrysler	2063PK	146	10246149	G.M.	9783PK	114
6504135	Chrysler	10391PK	75	10281487	G.M.	10211PK	70
6504521	Chrysler	2133PK	104	10285935	G.M.	9861PK	140
7642589	G.M.	9493PK	83	10287971	G.M.	9860PK	140
7693140	G.M.	9546PK	125	10293193	G.M.	10462PK	79
7698976	G.M.	9898PK	124	10297368	G.M.	9991PK	182
7730788	G.M.	817PK	125	10297371	G.M.	9990PK	182
7731589	G.M.	9853PK	178	10298115	G.M.	10106PK	173
8717859	G.M.	825PK	124	10305191	G.M.	10520PK	143
8731909	G.M.	9863PK	72	10323057	G.M.	10357PK	183
8799350	G.M.	9895PK	178	10352797	G.M.	10489PK	180
8911472	G.M.	1239PK	216	10352798	G.M.	10488PK	180
8911473	G.M.	1237PK	216	10352799	G.M.	9967PK	180
8911497	G.M.	1238PK	216	10352800	G.M.	10484PK	181
8917320	G.M.	1240PK	216	10363811	G.M.	10474PK	152
9422202	Chrysler	5790PK	7	10408480	G.M.	10543PK	142
9423101	G.M.	10455PK	17	10421018	G.M.	9862PK	141
9423950	Chrysler	10723PK	9	10423553	G.M.	9914PK	181
9424837	G.M.	1350PK	49	10431526	G.M.	10487PK	181
9431532	G.M.	1192PK	50	10431761	G.M.	10058PK	184
9431647	G.M.	9848PK	49	10437565	G.M.	9969PK	180
9432137	G.M.	1607PK	206	10443956	G.M.	9915PK	181
9433043	G.M.	5753PK	50	11500657	G.M.	1012PK	53
9433156	G.M.	1510PK	49	11500658	G.M.	5559PK	53
9436175	G.M.	4007PK	209	11500660	G.M.	5560PK	54
9437486	G.M.	9902PK	209	11500661	G.M.	5557PK	54
9437938	G.M.	4008PK	211	11500662	G.M.	5558PK	54
9440178	G.M.	5750PK	49	11500970	G.M.	1013PK	27
9685057	G.M.	1024PK	142	11500971	G.M.	5697PK	28
9716926	G.M.	1252PK	161	11500996	G.M.	5955PK	16
9721917	G.M.	1267PK	160	11501188	G.M.	5688PK	28
9731301	G.M.	985PK	125	11501193	G.M.	9064PK	28
9808241	G.M.	2065PK	124	11501794	G.M.	9161PK	2
9822198	G.M.	1251PK	161	11501818	G.M.	10241PK	69
9838109	G.M.	987PK	178	11501835	G.M.	1041PK	46
9895598	G.M.	9899PK	124	11501836	G.M.	1042PK	46
10009923	G.M.	3010PK	43	11501849	G.M.	1276PK	43
10032838	G.M.	1407PK	57	11501884	G.M.	9160PK	6
10036503	G.M.	9854PK	203	11501937	G.M.	1691PK	42
10053182	G.M.	1446PK	117	11502504	G.M.	1043PK	43
10063599	G.M.	5602PK	72	11502507	G.M.	1622PK	46
10077283	G.M.	1447PK	112	11502722	G.M.	5797PK	47
10108746	G.M.	2026PK	111	11502794	G.M.	9850PK	42
10121502	G.M.	9130PK	78	11502941	G.M.	5684PK	26

O.E.M. Crossover

O.E.M. #	Make	Disco#	Page#	O.E.M. #	Make	Disco#	Page#
11503395	G.M.	9887PK	13	11569697	GM	10805PK	180
11503396	G.M.	5925PK	13	11569918	GM	10823PK	179
11503619	G.M.	9147PK	27	11569920	G.M.	10802PK	179
11503695	G.M.	5916XPK	48	11570512	GM	10804PK	179
11503715	G.M.	5650PK	53	11588650	G.M.	10700PK	138
11503800	G.M.	5682PK	26	11588863	G.M.	10495PK	143
11503812	G.M.	10097PK	25	11588988	G.M.	10500PK	111
11503834	G.M.	5686PK	26	11589289	G.M.	10368PK	100
11503892	G.M.	5550PK	14	11589290	G.M.	10369PK	100
11503957	G.M.	5596PK	53	11589291	G.M.	10367PK	100
11503982	G.M.	5690PK	26	11589292	G.M.	10371PK	106
11504047	G.M.	9512PK	53	11589293	G.M.	10374PK	106
11504056	G.M.	9888PK	14	11589294	G.M.	10372PK	107
11504069	G.M.	7002PK	12	11589295	G.M.	10377PK	111
11504119	G.M.	9952PK	43	11589296	G.M.	10378PK	111
11504522	G.M.	7004PK	12	11609417	G.M.	10239PK	106
11504656	G.M.	7005PK	13	11610049	G.M.	10679PK	179
11504659	G.M.	7001PK	12	11610198	G.M.	10498PK	62
11504661	G.M.	7006PK	13	11610522	GM	10803PK	180
11504662	G.M.	7007PK	13	12015631	G.M.	9690PK	216
11504766	G.M.	5984PK	8	12048369	G.M.	1396PK	235
11505044	G.M.	5692PK	27	12337831	G.M.	10523PK	117
11505104	G.M.	1695PK	11	12337898	G.M.	1681PK	159
11505104	G.M.	5791PK	8	12337915	G.M.	1467PK	204
11505329	G.M.	1017PK	47	12337920	G.M.	9242PK	141
11505329	G.M.	5910PK	47	12338074	G.M.	2114PK	162
11507083	G.M.	5956PK	16	12540326	G.M.	2168PK	164
11509816	G.M.	9889PK	26	14001197	G.M.	10240PK	69
11513599	GM	10795PK	52	14003784	G.M.	9275PK	29
11517769	G.M.	10090PK	54,140	14007510	G.M.	9877PK	29
11517873	G.M.	10551PK	64	14007940	G.M.	1793PK	30
11518017	G.M.	10504PK	105	14013246	G.M.	2940PK	58
11518201	G.M.	10672PK	83	14019205	G.M.	5675PK	98
11518357	G.M.	10129PK	182	14027471	G.M.	9345PK	79
11519031	G.M.	10701PK	151	14032291	G.M.	1202PK	57
11519444	G.M.	10502PK	111	14045480	G.M.	5677PK	109
11561368	G.M.	10375PK	108	14063981	G.M.	5770PK	204
11561438	GM	10566PK	84	14071289	G.M.	5676PK	101
11561491	G.M.	10651PK	184	14074081	G.M.	5995PK	82
11561499	G.M.	10473PK	151	14093088	G.M.	5935PK	99
11561500	G.M.	10478PK	153	14101262	G.M.	10714PK	112
11561600	G.M.	10470PK	151	14103461	G.M.	1448PK	112
11561655	G.M.	10526PK	67	15002520	G.M.	9809PK	175
11561857	G.M.	10545PK	179	15014352	G.M.	10614PK	116
11562043	G.M.	10531	152	15021761	G.M.	10084PK	130
11562044	G.M.	10529	152	15022087	G.M.	9644PK	209
11562241	G.M.	10472PK	151	15056810	G.M.	9763PK	83
11562242	G.M.	10471PK	151	15078238	G.M.	10633PK	174
11562256	G.M.	10533	152	15116576	G.M.	10482PK	183
11562257	G.M.	10534	153	15127746	G.M.	10480PK	181
11562288	G.M.	10530	152	15149708	G.M.	9617PK	97
11562563	GM	10827PK	183	15153415	G.M.	10247PK	107

O.E.M. Crossover

O.E.M. #	Make	Disco#	Page#	O.E.M. #	Make	Disco#	Page#
15221959	G.M.	10429PK	183	20451401	G.M.	9502PK	144
15284612	G.M.	10554PK	62	20452072	G.M.	1390PK	203
15288146	G.M.	10481PK	182	20465395	G.M.	10565PK	202
15296830	G.M.	10370PK	105	20480475	G.M.	10399PK	140
15545202	G.M.	1646PK	140	20510029	G.M.	9369PK	99
15562609	G.M.	2115PK	161	20514862	G.M.	1583PK	73
15562610	G.M.	9233PK	160	20538173	G.M.	10657PK	90
15591860	G.M.	9164PK	163	20570245	G.M.	5940PK	104
15612948	G.M.	9339PK	142	20582532	G.M.	9437PK	128
15614746	G.M.	10630PK	204	20582533	G.M.	9438PK	128
15638413	G.M.	2017PK	142	20603072	G.M.	9548PK	124
15653790	G.M.	9825PK	163	20699808	G.M.	JL-23PK	74
15672328	G.M.	9195PK	84	20709017	G.M.	5618PK	75
15681408	G.M.	9320PK	97	20712176	G.M.	9421PK	159
15685073	G.M.	10083PK	129	20729523	G.M.	JL-24PK	72
15686142	G.M.	9199PK	173	20734005	G.M.	10398PK	142
15733970	G.M.	9695PK	122	21030249	G.M.	1860PK	104
15733971	G.M.	9694PK	121	21039129	G.M.	2167PK	85
15745990	G.M.	10550PK	68	21039141	G.M.	10393PK	88
15764320	G.M.	10540PK	122	21042045	G.M.	9224PK	143
15786626	G.M.	10479PK	158	21075686	G.M.	1861PK	103
15953247	G.M.	10653PK	143	21077123	G.M.	9559PK	98
15959832	G.M.	10382PK	113	21077131	G.M.	9592PK	112
15960325	G.M.	2029PK	141	21094146	G.M.	JL-33PK	82
15975244	G.M.	8862BPK	82	21095797	G.M.	9357PK	105
15994165	G.M.	10669PK	105	21097229	G.M.	9859PK	97
15994345	G.M.	10527	167	21097292	G.M.	10082PK	129
16500308	G.M.	1310PK	96	22189414	G.M.	10469PK	82
16606936	G.M.	9731PK	128	22512276	G.M.	9352PK	83
16629990	G.M.	9981PK	129	22535007	G.M.	5680PK	113
16630688	G.M.	9959PK	129	22539533	G.M.	1566PK	158
16630689	G.M.	9960PK	129	22546934	G.M.	10525PK	65
20030401	G.M.	1929PK	87	22547243	G.M.	10366PK	78
20032850	G.M.	1410PK	76	22567463	G.M.	9520PK	81
20043351	G.M.	1289PK	162	22587036	G.M.	10674PK	108
20064875	G.M.	1930PK	86	22603384	G.M.	10056PK	183
20130258	G.M.	1284PK	31	22641917	G.M.	9718PK	207
20160591	G.M.	1563PK	158	22699649	G.M.	10532	152
20162174	G.M.	1568PK	158	22722860	G.M.	10476PK	153
20175051	G.M.	1172PK	178	25016383	G.M.	8172PK	73
20180140	G.M.	9635PK	159	25501771	G.M.	1107PK	173
20199675	G.M.	1159PK	178	25524005	G.M.	2080PK	203
20319841	G.M.	9374PK	79	25601491	G.M.	10403PK	142
20328600	G.M.	1562PK	159	25647358	G.M.	10556PK	58
20421672	G.M.	9054PK	203	25648693	G.M.	10128PK	184
20421800	G.M.	4020PK	141	25693852	G.M.	10127PK	181
20423550	G.M.	6010PK	7	25722671	G.M.	10059PK	184
20423647	G.M.	9053PK	202	25724529	G.M.	10680PK	183
20429500	G.M.	1268PK	162	34202335	Chrysler	5640PK	81
20432975	G.M.	5769PK	202	88970494	G.M.	10716PK	115
20433026	G.M.	5775PK	204	90321122	G.M.	10703PK	146
20451119	G.M.	1265PK	117	96057846	G.M.	10655PK	98

O.E.M. Crossover

O.E.M. #	Make	Disco#	Page#	O.E.M. #	Make	Disco#	Page#
8942180270	Isuzu	9082PK	174	379830-S	Ford	1842PK	59
01281-00501	Nissan	2156PK	56	380707-S	Ford	9494PK	66
01281-00601	Nissan	10620PK	63	381671-S	Ford	1810PK	2
01281-00831	Nissan	10636PK	60	383033-S101	Ford	577PK	139
01553-00051	Nissan	1579PK	95	383132-S9	Ford	10242PK	69
01553-00202	Nissan	10417PK	95	383229-S	Ford	9893PK	205
01553-00291	Nissan	9886PK	94	38529-689A-6300	Honda	10408PK	95
01553-01393	Nissan	1998PK	120	385330-S	Ford	969PK	85
01553-01733	Nissan	10615PK	114	385661-S	Ford	9485PK	79
01553-03101	Nissan	2153PK	120	386299-S	Ford	10076PK	131
01553-06721	Nissan	1949PK	103	386553-S	Ford	9588PK	86
01553-09241	Nissan	9294PK	110	387182-S	Ford	9021PK	145
01553-09321	Nissan	9540PK	102	387477-S	Ford	9372PK	147
01553-09431	Nissan	10798PK	103	387496-S	Ford	1648PK	145
01553-09611	Nissan	10536PK	102	387944-S	Ford	9858PK	99
01553-S3500	Nissan	9539PK	148	388047-S100	Ford	1415PK	209
06508947-AA	Chrysler	10800PK	186	388047-S102	Ford	4009PK	209
06720-SJC-305(R)	Honda	10236PK	134	388442-S100	Ford	4002PK	210
06720-SJC-305(L)	Honda	10235PK	134	388664-S100	Ford	4005PK	208
0H452KD5	Chrysler	10423PK	98	388904-S	Ford	1149PK	80
11296-AG000	Nissan	10616PK	102	388908-S	Ford	1573PK	86
12493-05167B	Hyundai	10763PK	11	388930-S	Ford	5627PK	78
1395-68-676	Mazda	9108PK	113	389144-S	Ford	9514PK	145
14913-05010	Hyundai	10796PK	63	389443-S	Ford	9849PK	80
161-867-299	V.W.	10928PK	106	390428-S100	Ford	9453PK	208
161-867-299-01C	V.W.	10948PK	101	390522S	Ford	9729PK	131
171-807-249A	V.W.	10924PK	148	3B0-868-243	V.W.	10952PK	156
171-853-585	V.W.	10936PK	191	4-29-29-06	Fiat	9864PK	96
175-867-299	V.W.	1201PK	147	47749-58010	Toyota	10609PK	189
191-853-577A	V.W.	10935PK	140	4805405AA	Chrysler	10460PK	106
191-853-585A	V.W.	10939PK	155	4806110-AA	Chrysler	10519PK	111
1H0-853-585	V.W.	10921PK	192	4806240AA	Chrysler	10503PK	105
1H0-853-585B	V.W.	10946PK	192	4806334-AA	Chrysler	10542PK	107
1H0-853-586	V.W.	10923PK	192	4857345-AA	Chrysler	10666PK	109
1H0-853-733B	V.W.	10950PK	179	4860375-AB	Chrysler	10549PK	64
1H0-853-858A	V.W.	10925PK	192	4860379AA	Chrysler	10611PK	81
1H0-868-243	V.W.	10930PK	149	4878883AA	Chrysler	9980PK	85
1H0868243B	V.W.	10884PK	149	4A0-857-610	V.W.	10943PK	67
1H5-863-849-01C	V.W.	10944PK	89	4L3Z-1510182-AA	Ford	10691PK	184
1J0-853-120	V.W.	10922PK	60	5023111AA	Chrysler	10494PK	154
1W6Z-238A90-AA	Ford	10667PK	156	5028438-AA	Chrysler	10463PK	156
251-823-717	V.W.	10929PK	89	5160260AA	Chrysler	10511PK	104
27948-M7002	Nissan	10415PK	94	5189181-AA	Chrysler	10799PK	185
321-813-998A	V.W.	10938PK	61	52115-48040	Toyota	10806PK	189
321-867-299B	V.W.	10947PK	147	52161-16010	Toyota	9327PK	108
351050-S3	Ford	9876PK	139	52161-20010	Toyota	10628PK	108
354341-S	Ford	9941PK	44	52197-52010	Toyota	10807PK	191
357-827-998	V.W.	10942PK	64	52535-50060	Toyota	10745PK	66
358871-S8B	Ford	10244PK	68	53879-14010-A	Toyota	1601PK	50
372820-S36	Ford	9885PK	210	53879-22010	Toyota	1606PK	50
375480-S100	Ford	710PK	44	53879-58010	Toyota	10608PK	189
375890-S100	Ford	709PK	44	53879-60010	Toyota	10537PK	100

O.E.M. Crossover

O.E.M. #	Make	Disco#	Page#	O.E.M. #	Make	Disco#	Page#
53935-35020	Toyota	10971PK	68	71144-SR3-A00	Honda	10617PK	67
55156879-AB	Chrysler	10541PK	68	72111-S5P-A00	Honda	10230PK	133
55157055-AA	Chrysler	10483PK	185	72111-S9V-A00	Honda	10234PK	135
55157069-AB	Chrysler	10486PK	185	72112-SR4-004	Honda	10226PK	133
55157112-AA	Chrysler	10522PK	109	72113-SR4-004	Honda	10225PK	133
55157330-AC	Chrysler	10496PK	106	72116-SM4-003	Honda	10216PK	135
56912-S2	Ford	2970PK	9	72116-SV4-003	Honda	10217PK	136
56912-S2	Ford	5970PK	10	72134-S2X-003	Honda	10238PK	135
56914-S2	Ford	2975PK	10	72134-SM4-003	Honda	10232PK	135
57030-S2	Ford	204PK	24	72139-SR0-A01	Honda	10227PK	134
57041-S2	Ford	206PK	25	72139-SW5-003	Honda	10233PK	135
62217-13010	Toyota	10751PK	150	72151-S5P-A00	Honda	10229PK	133
622A2-9E00A	Nissan	10673PK	105	72174-S2X-003	Honda	10237PK	134
62380-U7400	Nissan	9418PK	68	72174-SM4-003	Honda	10231PK	135
62869-N4700	Nissan	10411PK	94	72616-SM4-003	Honda	10228PK	134
62955-20020	Toyota	10421PK	190	72634-SM4-003	Honda	10122PK	134
63844-01A00	Nissan	5901PK	118	72674-SM4-003	Honda	10121PK	133
63848-9E001	Nissan	10356PK	108	75305-SHJ-003	Honda	10790PK	186
63854-01A00	Nissan	10538PK	117	75392-6003	Lexus	10491PK	188
6505292AA	Chrysler	2108PK	155	75394-60060	Lexus	10397PK	188
6505539AA	Chrysler	10671PK	146	75395-33030	Lexus	10493PK	188
6505703AA	Chrysler	10668PK	60	75397-35010	Toyota	10492PK	191
6505759AA	Chrysler	10465PK	156	75492-60030	Lexus	10396PK	188
6505918-AA	Chrysler	10464PK	155	75495-35010	Toyota	10490PK	191
6506132-AA	Chrysler	10512PK	101	75498-42010	Toyota	10394PK	191
6506655AA	Chrysler	10467PK	153	75547-51021	Toyota	10765PK	206
6507009-AA	Chrysler	10524PK	61	75867-21010	Toyota	10750PK	190
6507055-AA	Chrysler	10649PK	145	76848-50Y00	Nissan	10619PK	57
6507669-AA	Chrysler	10518PK	110	76882-57A00	Nissan	1975PK	103
6507866AA	Chrysler	10665PK	84	76906-T3000	Nissan	1634PK	94
65722-EA000	Nissan	10203PK	138	7703-077-066	AMC	9500PK	76
65846-30F00	Nissan	2025PK	85	78867-AA010	Toyota	10635PK	190
66814-01G00	Nissan	1756PK	97	7L6-868-243	V.W.	10920PK	149
66820-3S500-C1	Nissan	10621PK	121	7M0-867-299K	V.W.	10927PK	150
66820-88E00	Nissan	10678PK	57, 121	80532-01R00	Nissan	10200PK	137
66824-01G00	Nissan	10656PK	97	80532-89900	Nissan	10196PK	137
66824-W1000	Nissan	1999PK	114	80532-AA100	Nissan	10198PK	136
66860-01W01	Nissan	2028PK	114	80533-01R00	Nissan	10201PK	137
67771-01010	Toyota	1588PK	155	80533-89900	Nissan	10197PK	137
67771-01010	Toyota	9081PK	155	80533-AA100	Nissan	10199PK	136
67771-12080	Toyota	10748PK	155	80874-0P00	Nissan	10618PK	56, 121
67771-30070	Toyota	2145PK	154	80999-05N07	Nissan	9114PK	100
69293-12050	Toyota	10116PK	138	80999-VE000	Nissan	10576PK	146
69293-12060	Toyota	10117PK	138	81126-37010	Hyundai	10782PK	88
69293-30030	Toyota	10120PK	138	811-807-577C	V.W.	10918PK	66
69293-33010	Toyota	10110PK	137	8133-50-022	Mazda	10407PK	96
69293-33020	Toyota	10109PK	137	81385-38000	Hyundai	10771PK	65
6G1Z-5410182-D	Ford	10629PK	184	819-055-BOK	V.W.	10941PK	79
6K0-868-243	V.W.	10932PK	147	82315-27000	Hyundai	10774PK	154
6K0-868-243C	V.W.	10931PK	149	82315-38000	Hyundai	10744PK	151
6N0-868-243A	V.W.	10933PK	149	823-863-203	V.W.	10934PK	74
6Q0-868-243	V.W.	10916PK	149	823-867-299	V.W.	10945PK	148

O.E.M. Crossover

O.E.M. #	Make	Disco#	Page#	O.E.M. #	Make	Disco#	Page#
85849-3B000	Hyundai	10773PK	154	90467-09093	Lexus	5895PK	119
86434-4A000	Hyundai	10766PK	92	90467-09101	Lexus	1943PK	119
86438-4A100	Hyundai	10767PK	92	90467-09145	Toyota	2027PK	119
86593-24000	Hyundai	10778PK	175	90467-09166	Toyota	10624PK	119
867-863-849-A01C	V.W.	10953PK	89	90467-10188	Toyota	10687PK	150
86825-28000	Hyundai	10785PK	50	90467-11063	Toyota	10392PK	190
86848-22000	Hyundai	10777PK	62	90467-11100	Toyota	10112PK	190
87719-3D000	Hyundai	10776PK	187	90467-13005	Toyota	1436PK	174
87756-2E000	Hyundai	10769PK	187	90467-17004	Toyota	1932PK	174
87756-35000	Hyundai	10775PK	65	90467-A0005	Toyota	10724PK	150
87756-38000	Hyundai	10784PK	187	90468-04030	Toyota	1584PK	174
87756-3D000	Hyundai	10783PK	60	90505-SL0-003	Acura	2163PK	119
87758-35000	Hyundai	10780PK	187	90505-SM4-003	Honda	1973PK	117
87758-37000	Hyundai	10779PK	61	90505-SX0-003	Honda	10075PK	104
87758-3D000	Hyundai	10770PK	188	90602-SAA-003	Honda	10752PK	186
87759-27000	Hyundai	10772PK	61	90602-SEP-A00	Acura	10824PK	108
8934-201-767	Renault	9878PK	44	90652-SB2-023	Honda	9547PK	126
8934-201-835	AMC	10561PK	204	90656-671-6310M1	Honda	9101PK	65
8E0-868-243	V.W.	10917PK	156	90657-SA6-0030	Honda	2015PK	116
90080-82053	Toyota	10833PK	218	90657-SB0-003	Honda	10890PK	198
90108-SW3-003	Honda	9977PK	95	90661-SC7-0030	Honda	1572PK	60
90114-SE0-000	Honda	10096PK	12	90662-671-0030	Honda	1296PK	63
90183-03001	Toyota	1585PK	174	90662-693-0030	Honda	9591PK	56
90189-04011	Toyota	9112PK	56	90664-671-0030	Honda	9560PK	91
90189-04059	Lexus	10808PK	56	90666-SA0-0030	Honda	9857PK	73
90189-05013	Toyota	1560PK	63	90667-SA7-0030	Honda	2034PK	73
90189-06001	Toyota	1576PK	63	90670-692-0030	Honda	10416PK	95
90189-06006	Toyota	10659PK	63	90672-671-8110M1	Honda	1636PK	56
90189-06010	Toyota	1614PK	62	90672-SA0-0030	Honda	9279PK	217
90189-06013	Toyota	1605PK	66	90675-SB3-003	Honda	5920PK	117
90189-06018	Toyota	1610PK	62	90684-SA5-0030	Honda	1597PK	114
90189-06028	Toyota	9912PK	64	90687-671-0030	Honda	10412PK	96
90189-06157	Toyota	9913PK	64	90687-SA5-0030	Honda	9554PK	93
90189-06193	Toyota	10794PK	62	90688-SB0-003	Honda	5930PK	114
90269-04050	Toyota	10458PK	207	90700-SB2-003	Honda	10379PK	85
90269-05054	Toyota	10510PK	208	90700-SJ4-000	Acura	9945PK	88
90269-05065	Lexus	10764PK	208	90904-67036	Toyota	10113PK	191
90269-06013	Toyota	10459PK	208	90904-67037	Toyota	9946PK	190
90467-05090	Toyota	10686PK	113	90950-01248	Toyota	10414PK	96
90467-06017	Toyota	1603PK	116	91500-SM4-999AH	Honda	2123PK	17
90467-06161-01	Toyota	9074PK	93	91501-S04-003	Honda	9292PK	102
90467-07044	Toyota	10413PK	116	91501-S1K-003	Honda	10435PK	87
90467-07050	Toyota	1466PK	93	91501-SG0-003	Acura	1946PK	186
90467-07138	Lexus	2143PK	116	91501-SM4-003	Honda	2002PK	95
90467-07166	Toyota	9465PK	101	91502-SM4-0000	Honda	D-123PK	120
90467-07188	Toyota	10623PK	101	91502-SP0-003	Honda	2060PK	120
90467-07192	Toyota	10825PK	100	91503-S0K-A01	Honda	10625PK	109
90467-08004	Toyota	1996PK	93	91503-SP0-0030	Acura	9202PK	119
90467-08124	Toyota	9403PK	87	91503-SZ3-003	Honda	9282PK	110
90467-09006	Toyota	9328PK	88	91503-SZ5-003	Honda	9382PK	110
90467-09008	Toyota	1950PK	88	91504-SM4-0000	Honda	D-124PK	120
90467-09050	Toyota	10141PK	87	91505-S9A-003	Honda	10681PK	109

O.E.M. Crossover

O.E.M. #	Make	Disco#	Page#	O.E.M. #	Make	Disco#	Page#
91505-ST7-003ZA	Honda	10610PK	148	G18K-51-SJ3	Mazda	10749PK	156
91506-S9A-003	Honda	10955PK	110	GA2A-68-AB1A	Mazda	10575PK	148
91508-SM4-003	Honda	2057PK	102	HB-121467	Mitsubishi	9901PK	96
91508-SR3-000	Honda	2056PK	103	J4007456	Chrysler	9988PK	133
91510-SR3-003	Honda	2142PK	187	MB-455-56143	Ford	9287PK	118
91512-SE0-003	Honda	1994PK	126	MB619582	Mitsubishi	10797PK	97
91512-SM4-003	Honda	1976PK	118	MR200300	Mitsubishi	9943PK	107
91512-SX0-003	Acura	2128PK	102	N0385501	V.W.	10940PK	101
91516-SK7-013	Honda	1972PK	118	N606676-S2	Ford	5698PK	26
91518-SM4-003	Honda	9262PK	94	N606677-S	Ford	5705PK	27
91520-SM4-C010	Honda	5606PK	94	N606677-S36	Ford	5699PK	27
91527-SM4-003	Honda	9752PK	187	N621903-S2	Ford	1639PK	47
91528-SR4-003	Honda	9696PK	186	N800369-S2	Ford	1939PK	17
91530-SP1-003	Honda	9208PK	92	N-800503S	Ford	1227PK	58
91530-ST5-003	Honda	9336PK	92	N80101994S	Ford	JL-26PK	74
91534-SE0-000	Honda	1945PK	186	N801603-S61	Ford	10365PK	12
91545-SE0-0030-W1	Honda	9390PK	103	N801851-S	Ford	1589PK	30
91550-SH3-003	Honda	2155PK	116	N801925-S	Ford	1575PK	147
91560-S9A-A01	Honda	10573PK	150	N802734S	Ford	5635PK	80
91560-SM4-003	Honda	9444PK	148	N802900	Ford	1558PK	145
91561-SJD-003	Honda	10788PK	150	N803170-S	Ford	9178PK	72
91566-SP0-003	Honda	2144PK	153	N803387	Ford	10670PK	87
91568-SR2-003	Honda	10388PK	90	N803421-S	Ford	1263PK	104
91591-SJ6-013	Honda	10114PK	136	N803494S	Ford	1399PK	115
91620-SR2-003	Honda	2157PK	55	N803613S	Ford	9513PK	87
91635-SM4-003	Honda	10426PK	64	N803933-S101	Ford	9454PK	205
96706-B0700	Nissan	1577PK	58	N803946S	Ford	9968PK	115
979878-6	Volvo	2287PK	207	N804344S	Ford	9726PK	130
9927-40-822	Mazda	10405PK	154	N804349S	Ford	2048PK	80
9927-80-404	Mazda	10223PK	136	N804379S	Ford	5648PK	83
9927-80-405	Mazda	10224PK	136	N804448	Ford	9446PK	78
BC1D-56-145	Mazda	10747PK	118	N804472-S	Ford	10560PK	203
C5AB-6220586A	Ford	9875PK	89	N804570S	Ford	9067PK	115
C5ZZ-6543413-B	Ford	9550PK	126	N804583S	Ford	1374PK	202
C6AB-6242413-A	Ford	9874PK	125	N804675S	Ford	9128PK	204
C8AZ-63642413-A	Ford	9545PK	126	N804837S	Ford	9509PK	115
D0DZ-15A434B	Ford	9775PK	237	N805155-S	Ford	2112PK	144
D90Z-6522841A	Ford	1270PK	161	N805350S	Ford	9725PK	130
D9ZZ-6643030-AA	Ford	9595PK	164	N805592-S100	Ford	1609PK	207
E1FZ16828-C	Ford	10079PK	131	N805612-S100	Ford	1742PK	145
E3SB6342413AB	Ford	1371PK	125	N805759-S100	Ford	9118PK	205
E6AZ-5421952-A	Ford	9728PK	130	N806624-S191	Ford	9720PK	173
E6DZ-5421952A	Ford	10078PK	130	N806860-S100	Ford	1951PK	210
E7EB5802354AAJABH	Ford	JL-120PK	81	N807168-S	Ford	9618PK	208
E83Z-16828A	Ford	10081PK	131	N807578-S	Ford	10468PK	115
E8UZ1522840	Ford	9937PK	165	N807721-S	Ford	5643PK	82
E9DB-13N020AA	Ford	1864PK	173	N807994-S	Ford	9355PK	67
F1CZ-16774-A	Ford	9522PK	85	N808229-S100	Ford	10828PK	210
F1TZ-7810182-A	Ford	2161PK	185	N808370-S	Ford	5614PK	74
F58Z-16237A02-A	Ford	10098PK	147	N808689-417	Ford	9989PK	210
F85Z-152195-BB	Ford	10080PK	131	N808842-S	Ford	2111PK	86
G043-50-742	Mazda	10574PK	188	N811169-S	Ford	9712PK	67

O.E.M. Crossover

O.E.M. #	Make	Disco#	Page#
N811478-S100	Ford	10461PK	66
N811534-S61	Ford	10684PK	14
N900-845-01	V.W.	9277PK	206
N90-796-502	V.W.	10937PK	42
N908-214-01	V.W.	10926PK	61
OWX68BD1-AA	Chrysler	10499PK	107
W525172-S417	Ford	4014PK	209
W525175-S	Ford	4015PK	210
W700671-S300	Ford	10677PK	88
W7013580-SSW	Ford	10675PK	82
W701374-S	Ford	10613PK	84
W701971-S	Ford	10544PK	144
W702380-S300	Ford	10077PK	131
W705590-S300	Ford	10552PK	61
W707889-S300	Ford	10064PK	76
W708771-S300	Ford	10066PK	185
W709002	Ford	10568PK	75
W710312-S300	Ford	10517PK	81
W710793-S439	Ford	10969PK	175
W711412-S300	Ford	10497PK	59
W712160-S300	Ford	10715PK	65
W713297-S300	Ford	10612PK	154
W713445-S300	Ford	10914PK	118
W713590-5300	Ford	10913PK	185
WX68DX9-AA	Chrysler	10516PK	107
XG300/350	Hyundai	10781PK	67
XL3Z17E971-AA	Ford	5678PK	110

